

escha.net

**ESCHA**

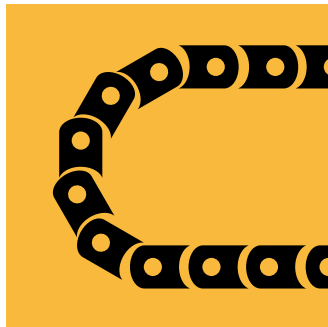

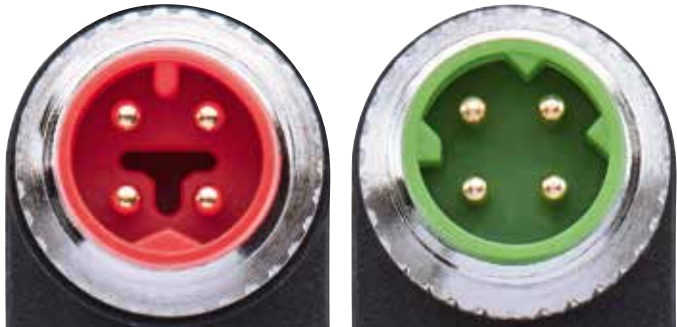
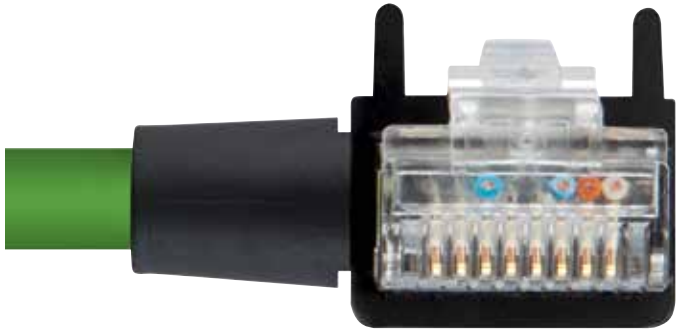
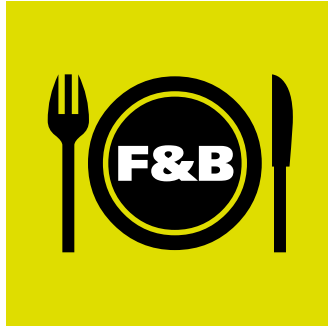
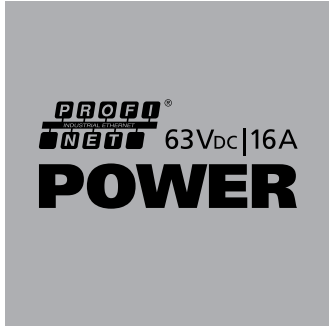
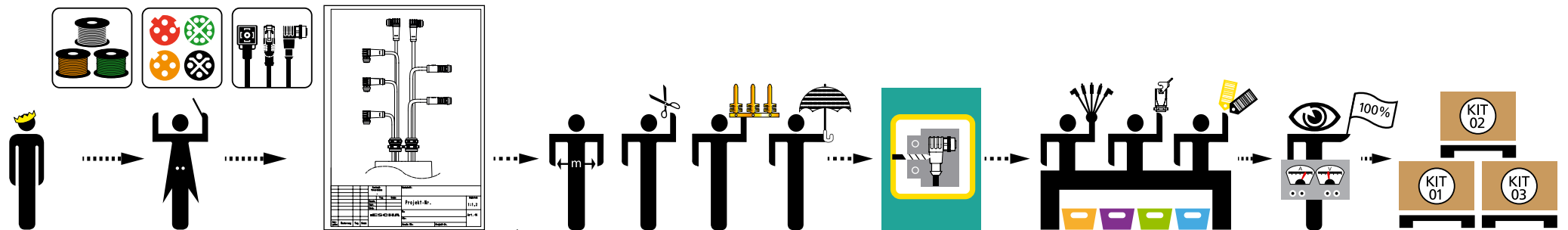
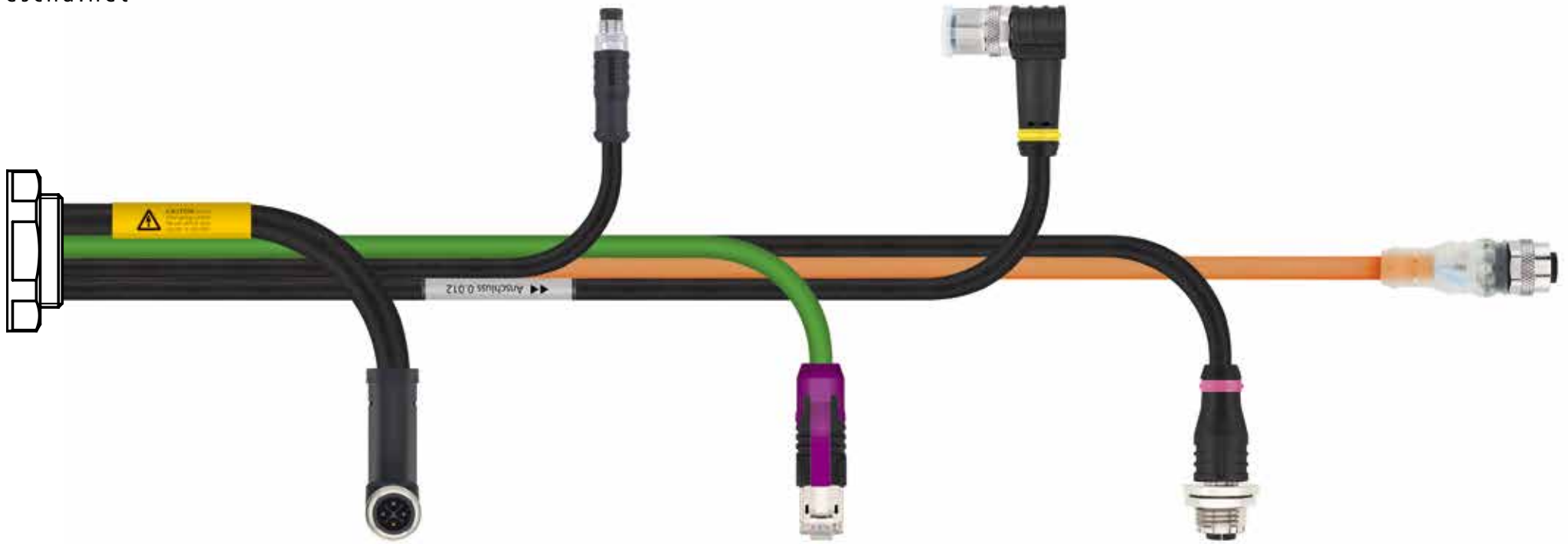

## 编辑

### 工业连接4.0

此目录展示了用于各种应用的完整系统接线所需的连接器，您可以信赖的全部M8x1及M12x1系列产品。这些产品可以为传感器/驱动器布线、电源及数据传输提供高等级并工业验证过的连接解决方案。

特别是在工业以太网连接器领域，您可以发现大量的产品创新。这些针对高频领域的创新，为将来需要的高速且可靠的数据传输提供巨大潜力。

另外，您可以在我们的电子产品目录中找到各种需要的产品。您可以通过访问escha.net网站，下载此目录，并且通过点击项目号直接查询到产品的详细信息。此外，提供通用的BMEcat格式，可以快速简单的在产品目录中找到所需产品。ESCHA数据符合eCl@ss 及 ETIM标准分类系统。

如果此目录不包括您应用所需的产品，请即时联系我们。如果需要针对客户进行修改或甚至进行个性化开发，ESCHA是您理想的合作伙伴！

AL	传感器执行器	4
FB	Food & Beverage 食品&饮料加工行业	52
HT	高温	58
	法兰连接	62
	现场接线连接器	82
IE	工业以太网	88
	RJ45 接插件	104
PB	Profibus	110
CD	CANopen/DeviceNet	116
P	M12x1 POWER 电源	120
	T型分离器   Y型分离器	132
	Y型分离器 使用电缆出口	140
IO	I/O-分线盒   被动	148
IO	I/O-分线盒   活跃	152
	M23x1 连接器	156
V	阀连接器	160
	附件	168
	电缆材质	178
	100m 线缆编号	182
	技术信息	186
	针脚分配	192



对接连接器命名

连接电缆

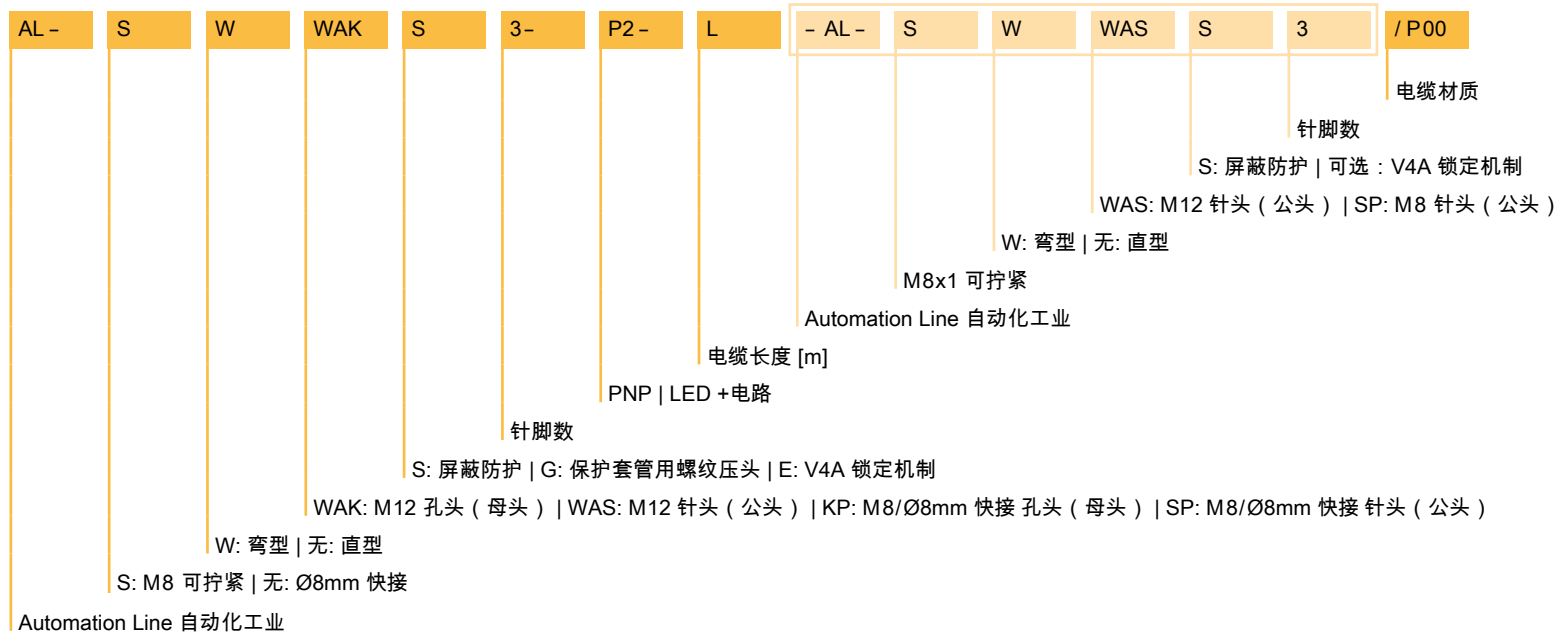

电缆	材料	UL	颜色	特性	可适应拖链	抗扭	抗焊接火花
P00	PVC/PVC		GY				
P01	PVC/PVC	✓	GY				
P01BK	PVC/PVC	✓	BK				
S370	PUR/PP	✓	BK		✓	✓	✓
S370GY	PUR/PP	✓	GY		✓	✓	✓
S7400	PUR/PP	✓	OG	机器人, 高机械应力	✓	✓	✓
S400	PUR/PP	✓	BK	手动剥电缆可达1.5米	✓	✓	✓
S570	PUR/PP	✓	BK	线芯横截面积 3x0.14mm <sup>2</sup> + 2x0.34mm <sup>2</sup>	✓	✓	✓

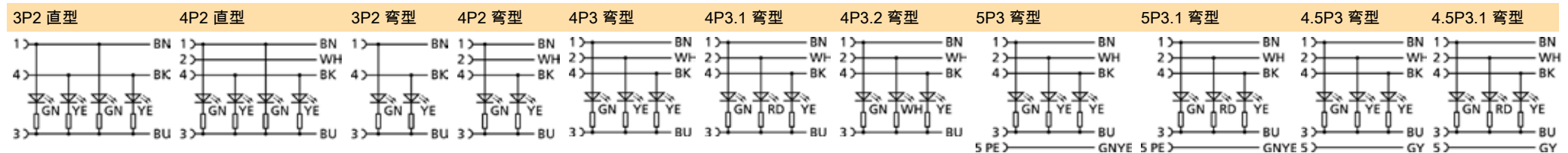



\*见宣传页 "M12 with plastic locking nut"

M12	延长电缆	6
	连接电缆	15
	延长电缆, 屏蔽	21
	连接电缆, 屏蔽	25
M8	延长电缆	29
	连接电缆	32
	延长电缆, 屏蔽	34
	连接电缆, 屏蔽	35
Ø8mm 快插	延长电缆	37
	连接电缆	40
法兰连接	M12	42
	M8	50

## 传感器执行器

技术参数	M12	M8	Ø8mm snap	法兰连接
绝缘电阻	≥10 <sup>8</sup> Ω	≥10 <sup>8</sup> Ω	≥10 <sup>8</sup> Ω	≥10 <sup>8</sup> Ω
电阻	≤ 5mΩ	≤ 5mΩ	≤ 5mΩ	≤ 5mΩ
产品环境温度	-30°C...+90°C	-30°C...+90°C	-30°C...+90°C	-30°C...+90°C
触点材料	合金, 镀金	合金, 镀金	合金, 镀金	合金, 镀金
触头载体材料	塑料, TPU	塑料, TPU	塑料, TPU	塑料
夹紧基体材料	塑料, TPU	塑料, TPU	塑料, TPU	塑料
连接螺母材料	合金, 镀镍	合金, 镀镍		
密封(母头)材料	FPM/FKM	FPM/FKM	FPM/FKM	FPM/FKM
标准	IEC 61076-2-101	IEC 61076-2-104	IEC 61076-2-104	IEC 61076-2-101/-109
防护等级 (安装好)	IP65, IP67, IP68	IP65, IP67, IP68	IP65, IP67, IP68	IP65, IP67, IP68
机械寿命周期	>100 插拔次数	>100 插拔次数	>100 插拔次数	>100 插拔次数
污染等级	3	3/2	3/2	3



我们用于传感器/执行器连接的连接器，满足自动化行业的典型要求: 无卤素，不含PVC，不含硅胶；适用于拖链；防焊渣；耐化学物质，耐油性，抗微生物和水解

在任何一个产品上，自动化工业系列满足自动化工业典型的需求：无卤素，不含PVC，不含硅胶；适用于拖链；防焊渣；耐化学物质，耐油性，抗微生物和水解。此外严格按照IP67和UL认证。产品多样化：LED版本；带螺纹保护套管；符合ESCHA 2SSK- 360°度全屏蔽专利技术。可提供线缆材质：PVC，PUR和适用于更高等级拖链和抗弯曲的PUR机器人电缆。

根据要求，您可以订购我们的M12连接器与耐高温和介质塑料锁定螺母。它们有不同的颜色，因此可以方便地分配插槽。

	顶端				电缆			产品描述	L = 电缆长度*		
	针脚	最大电压	最大电流	LED	材料	颜色	UL		2m / 1m	5m / 2m	10m / 5m
 延长电缆 母头，直型，M12	3	250V	4A	PUR	BK	•	AL-WAK3-L/S370	8043798	8043799	8043800	
			4A	PUR	BK	•	AL-WAK3-L/S400	8075472	8075473	8075474	
			4A	PUR	GY	•	AL-WAK3-L/S370GY	8058853	8058854	8058855	
			4A	PUR	OG	•	AL-WAK3-L/S7400	8058862	8058863	8058864	
			4A	PVC	BK	•	AL-WAK3-L/P01BK	8081847	8081848	8081849	
			4A	PVC	GY	•	AL-WAK3-L/P01	8051250	8051251	8051252	
			4A	PVC	GY		AL-WAK3-L/P00	8051043	8051044	8051045	
	4	250V	4A	PUR	BK	•	AL-WAK4-L/S370	8043811	8043812	8043813	
			4A	PUR	BK	•	AL-WAK4-L/S400	8075490	8075491	8075492	
			4A	PUR	GY	•	AL-WAK4-L/S370GY	8058856	8058857	8058858	
			4A	PUR	OG	•	AL-WAK4-L/S7400	8058865	8058866	8058867	
			4A	PVC	BK	•	AL-WAK4-L/P01BK	8081859	8081860	8081861	
			4A	PVC	GY	•	AL-WAK4-L/P01	8051262	8051263	8051264	
			4A	PVC	GY		AL-WAK4-L/P00	8049341	8051055	8051056	
	4+PE	60V	4A	PUR	BK	•	AL-WAK5-L/S370	8045034	8045035	8046043	
			4A	PUR	BK	•	AL-WAK5-L/S400	8075529	8075530	8075531	
			4A	PUR	GY	•	AL-WAK5-L/S370GY	8058859	8058860	8058861	
			4A	PUR	OG	•	AL-WAK5-L/S7400	8058868	8058869	8058870	
			4A	PVC	BK	•	AL-WAK5-L/P01BK	8081871	8081872	8081873	
			4A	PVC	GY	•	AL-WAK5-L/P01	8051286	8051287	8051288	
			4A	PVC	GY		AL-WAK5-L/P00	8051077	8051078	8051079	
	5	60V	4A	PUR	BK	•	AL-WAK4.5-L/S370	8043823	8043824	8043825	
			4A	PUR	BK	•	AL-WAK4.5-L/S400	8075638	8075639	8075640	
			4A	PUR	GY	•	AL-WAK4.5-L/S370GY	8092295	8092296	8092297	
			4A	PUR	OG		AL-WAK4.5-L/S7400	8084858	8085288	8085289	
			4A	PVC	GY	•	AL-WAK4.5-L/P01	8051274	8051275	8051276	
			4A	PVC	GY		AL-WAK4.5-L/P00	8051067	8051068	8051069	
	8	30V	2A	PUR	BK	•	AL-WAK8-L/S370	8046903	8046904	8046905	
			2A	PUR	BK	•	AL-WAK8-L/S400	8075556	8075557	8075558	
			2A	PUR	GY	•	AL-WAK8-L/S370GY	8092331	8092332	8092333	
			2A	PVC	GY	•	AL-WAK8-L/P01	8051298	8051299	8051300	
			2A	PVC	GY		AL-WAK8-L/P00	8051089	8051090	8051091	



标准连接器的长度:2米,5米,或10米。中继电缆长度:1米,2米或5米。法兰面板安装的电线长度:0.5米(0.2米)。其他电缆,电线长度可按照客户要求定制。

	顶端	顶端				电缆			产品描述	L = 电缆长度*		
		针脚	最大电压	最大电流	LED	材料	颜色	UL		2m / 1m	5m / 2m	10m / 5m
 延长电缆 母头, 直型, M12	12	30V	1.5A		PUR	BK	•	AL-WAK12-L/S370	8046918	8046920	8046921	
			1.5A		PUR	BK	•	AL-WAK12-L/S400	8075568	8075569	8075570	
			1.5A		PUR	GY	•	AL-WAK12-L/S370GY	8092357	8092358	8092359	
			1.5A		PVC	GY	•	AL-WAK12-L/P01	8051310	8051311	8051312	
			1.5A		PVC	GY		AL-WAK12-L/P00	8051101	8051102	8051103	
 延长电缆 母头, 直型, M12, 带LED	3	30V	4A	3P2	PUR	BK	•	AL-WAK3P2-L/S370	8044524	8045592	8047386	
			4A	3P2	PUR	BK	•	AL-WAK3P2-L/S400	8075475	8075476	8075477	
			4A	3P2	PUR	GY	•	AL-WAK3P2-L/S370GY	8058922	8058923	8058924	
			4A	3P2	PUR	OG	•	AL-WAK3P2-L/S7400	8058928	8058929	8058930	
			4A	3P2	PVC	BK	•	AL-WAK3P2-L/P01BK	8082022	8082023	8082024	
			4A	3P2	PVC	GY	•	AL-WAK3P2-L/P01	8052511	8052512	8052513	
			4A	3P2	PVC	GY		AL-WAK3P2-L/P00	8052508	8052509	8052510	
	4	30V	4A	4P2	PUR	BK	•	AL-WAK4P2-L/S370	8048938	8048114	8048116	
			4A	4P2	PUR	BK	•	AL-WAK4P2-L/S400	8075493	8075494	8075495	
			4A	4P2	PUR	GY	•	AL-WAK4P2-L/S370GY	8058925	8058926	8058927	
			4A	4P2	PUR	OG	•	AL-WAK4P2-L/S7400	8058931	8058932	8058933	
			4A	4P2	PVC	BK	•	AL-WAK4P2-L/P01BK	8082025	8082026	8082027	
			4A	4P2	PVC	GY	•	AL-WAK4P2-L/P01	8052517	8052518	8052519	
			4A	4P2	PVC	GY		AL-WAK4P2-L/P00	8052514	8052515	8052516	
 延长电缆 母头, 直型, M12, 保护套管带螺纹压头	4	250V	4A		PUR	BK	•	AL-WAKG4-L/S370	8052820	8052821	8052822	
			4A		PUR	BK	•	AL-WAKG4-L/S400	8075496	8075497	8075498	
			4A		PUR	GY	•	AL-WAKG4-L/S370GY	8059086	8059087	8059088	
			4A		PUR	OG	•	AL-WAKG4-L/S7400	8059089	8059090	8059091	
			4A		PVC	BK	•	AL-WAKG4-L/P01BK	8082551	8082552	8082553	
			4A		PVC	GY	•	AL-WAKG4-L/P01	8052826	8052827	8052828	
			4A		PVC	GY		AL-WAKG4-L/P00	8052823	8052824	8052825	



	顶端				电缆			产品描述	L = 电缆长度*		
	针脚	最大电压	最大电流	LED	材料	颜色	UL		2m / 1m	5m / 2m	10m / 5m
 延长电缆 母头, 弯型, M12	3	250V	4A	PUR	BK	•	AL-WWAK3-L/S370	8043801	8043802	8043803	
			4A	PUR	BK	•	AL-WWAK3-L/S400	8075481	8075482	8075483	
			4A	PUR	GY	•	AL-WWAK3-L/S370GY	8058871	8058872	8058873	
			4A	PUR	OG	•	AL-WWAK3-L/S7400	8058880	8058881	8058882	
			4A	PVC	BK	•	AL-WWAK3-L/P01BK	8081850	8081851	8081852	
			4A	PVC	GY	•	AL-WWAK3-L/P01	8051253	8051254	8051255	
			4A	PVC	GY		AL-WWAK3-L/P00	8051046	8051047	8051048	
	4	250V	4A	PVC	BK	•	AL-WWAK4-L/P01BK	8081862	8081863	8081864	
			4A	PUR	BK	•	AL-WWAK4-L/S370	8043814	8043815	8043816	
			4A	PUR	BK	•	AL-WWAK4-L/S400	8075505	8075506	8075507	
			4A	PUR	GY	•	AL-WWAK4-L/S370GY	8058874	8058875	8058876	
			4A	PUR	OG	•	AL-WWAK4-L/S7400	8058883	8058884	8058885	
			4A	PVC	GY	•	AL-WWAK4-L/P01	8051265	8051266	8051267	
			4A	PVC	GY		AL-WWAK4-L/P00	8049342	8049343	8051057	
	4+PE	60V	4A	PUR	BK	•	AL-WWAK5-L/S370	8046021	8046022	8046023	
			4A	PUR	BK	•	AL-WWAK5-L/S400	8075535	8075536	8075537	
			4A	PUR	GY	•	AL-WWAK5-L/S370GY	8058877	8058878	8058879	
			4A	PUR	OG	•	AL-WWAK5-L/S7400	8058886	8058887	8058888	
			4A	PVC	BK	•	AL-WWAK5-L/P01BK	8081874	8081875	8081876	
			4A	PVC	GY	•	AL-WWAK5-L/P01	8051289	8051290	8051291	
			4A	PVC	GY		AL-WWAK5-L/P00	8051080	8051081	8051082	
	5	60V	4A	PUR	BK	•	AL-WWAK4.5-L/S370	8043826	8043827	8043828	
			4A	PUR	BK	•	AL-WWAK4.5-L/S400	8075550	8075551	8075552	
			4A	PUR	GY	•	AL-WWAK4.5-L/S370GY	8091079	8092301	8092304	
			4A	PUR	OG		AL-WWAK4.5-L/S7400	8084859	8085290	8085291	
			4A	PVC	GY	•	AL-WWAK4.5-L/P01	8051277	8051278	8051279	
			4A	PVC	GY		AL-WWAK4.5-L/P00	8049344	8051070	8051071	
	8	30V	2A	PUR	BK	•	AL-WWAK8-L/S370	8046906	8046907	8046908	
			2A	PUR	BK	•	AL-WWAK8-L/S400	8075562	8075563	8075564	
			2A	PUR	GY	•	AL-WWAK8-L/S370GY	8092337	8092338	8092339	
			2A	PVC	GY	•	AL-WWAK8-L/P01	8051301	8051302	8051303	
			2A	PVC	GY		AL-WWAK8-L/P00	8051092	8051093	8051094	

标准连接器的长度:2米,5米,或10米。中继电缆长度:1米,2米或5米。法兰面板安装的电线长度:0.5米(0.2米)。其他电缆,电线长度可按照客户要求定制。



	顶端				电缆			产品描述	L = 电缆长度*		
	针脚	最大电压	最大电流	LED	材料	颜色	UL		2m / 1m	5m / 2m	10m / 5m
 延长电缆 母头, 弯型, M12	12	30V	1.5A		PUR	BK	•	AL-WWAK12-L/S370	8046923	8046924	8046925
			1.5A		PUR	BK	•	AL-WWAK12-L/S400	8075574	8075575	8075576
			1.5A		PUR	GY	•	AL-WWAK12-L/S370GY	8092364	8092365	8092366
			1.5A		PVC	GY	•	AL-WWAK12-L/P01	8051313	8051314	8051315
			1.5A		PVC	GY		AL-WWAK12-L/P00	8051104	8051105	8051106
 延长电缆 母头, 弯型, M12, 带LED	3	30V	4A	3P2	PUR	BK	•	AL-WWAK3P2-L/S370	8044219	8045217	8044523
			4A	3P2	PUR	BK	•	AL-WWAK3P2-L/S400	8075484	8075485	8075486
			4A	3P2	PUR	GY	•	AL-WWAK3P2-L/S370GY	8059930	8059931	8059932
			4A	3P2	PUR	OG	•	AL-WWAK3P2-L/S7400	8058934	8058935	8058936
			4A	3P2	PVC	BK	•	AL-WWAK3P2-L/P01BK	8081889	8081890	8081891
			4A	3P2	PVC	GY	•	AL-WWAK3P2-L/P01	8051328	8051329	8051330
			4A	3P2	PVC	GY		AL-WWAK3P2-L/P00	8051121	8051119	8051120
			4A	3P2	PVC	GY		AL-WWAK3P2-L/P00	8051121	8051119	8051120
	4	30V	4A	4P2	PUR	BK	•	AL-WWAK4P2-L/S370	8045237	8045238	8045239
			4A	4P2	PUR	BK	•	AL-WWAK4P2-L/S400	8075508	8075509	8075510
			4A	4P2	PUR	GY	•	AL-WWAK4P2-L/S370GY	8059933	8059934	8059935
			4A	4P2	PUR	OG	•	AL-WWAK4P2-L/S7400	8058937	8058938	8058939
			4A	4P2	PVC	BK	•	AL-WWAK4P2-L/P01BK	8081892	8081893	8081894
			4A	4P2	PVC	GY	•	AL-WWAK4P2-L/P01	8051331	8051332	8051333
			4A	4P2	PVC	GY		AL-WWAK4P2-L/P00	8051122	8051123	8051124
			4A	4P3	PUR	BK	•	AL-WWAK4P3-L/S370	8044220	8044565	8044566
			4A	4P3	PUR	BK	•	AL-WWAK4P3-L/S400	8075511	8075512	8075513
			4A	4P3	PUR	GY	•	AL-WWAK4P3-L/S370GY	8059936	8059937	8059938
			4A	4P3	PUR	OG	•	AL-WWAK4P3-L/S7400	8058940	8058941	8058942
			4A	4P3	PVC	BK	•	AL-WWAK4P3-L/P01BK	8081895	8081896	8081897
			4A	4P3	PVC	GY	•	AL-WWAK4P3-L/P01	8051334	8051335	8051336
			4A	4P3	PVC	GY		AL-WWAK4P3-L/P00	8051125	8051126	8051127
			4A	4P3.1	PUR	BK	•	AL-WWAK4P3.1-L/S370	8045911	8045912	8045913
			4A	4P3.1	PUR	BK	•	AL-WWAK4P3.1-L/S400	8075514	8075515	8075516
			4A	4P3.1	PUR	GY	•	AL-WWAK4P3.1-L/S370GY	8059939	8059940	8059941
			4A	4P3.1	PUR	OG	•	AL-WWAK4P3.1-L/S7400	8058943	8058944	8058945
			4A	4P3.1	PVC	BK	•	AL-WWAK4P3.1-L/P01BK	8081898	8081899	8081900
			4A	4P3.1	PVC	GY	•	AL-WWAK4P3.1-L/P01	8051337	8051338	8051339
4A	4P3.1	PVC	GY		AL-WWAK4P3.1-L/P00	8051128	8051129	8051130			

标准连接器的长度:2米,5米,或10米。中继电缆长度:1米,2米或5米。法兰面板安装的电线长度:0.5米(0.2米)。其他电缆,电线长度可按照客户要求定制。

	顶端				电缆			产品描述	L = 电缆长度*		
	针脚	最大电压	最大电流	LED	材料	颜色	UL		2m / 1m	5m / 2m	10m / 5m
 <p>延长电缆 母头, 弯型, M12, 带LED</p>	4	30V	4A	4P3.2	PUR	BK	•	AL-WWAK4P3.2-L/S370	8045914	8045915	8045916
			4A	4P3.2	PUR	BK	•	AL-WWAK4P3.2-L/S400	8075517	8075518	8075519
			4A	4P3.2	PUR	GY	•	AL-WWAK4P3.2-L/S370GY	8059942	8059943	8059944
			4A	4P3.2	PUR	OG	•	AL-WWAK4P3.2-L/S7400	8058946	8058947	8058948
			4A	4P3.2	PVC	BK	•	AL-WWAK4P3.2-L/P01BK	8081901	8081902	8081903
			4A	4P3.2	PVC	GY	•	AL-WWAK4P3.2-L/P01	8051340	8051341	8051342
			4A	4P3.2	PVC	GY		AL-WWAK4P3.2-L/P00	8051131	8051132	8051133
			4+PE	30V	4A	5P3	PUR	BK	•	AL-WWAK5P3-L/S370	8044221
	4A	5P3	PUR	BK	•	AL-WWAK5P3-L/S400	8075538	8075539	8075540		
	4A	5P3	PUR	GY	•	AL-WWAK5P3-L/S370GY	8059945	8059946	8059947		
	4A	5P3	PUR	OG	•	AL-WWAK5P3-L/S7400	8058949	8058950	8058951		
	4A	5P3	PVC	BK	•	AL-WWAK5P3-L/P01BK	8081904	8081905	8081906		
	4A	5P3	PVC	GY	•	AL-WWAK5P3-L/P01	8051343	8051344	8051345		
	4A	5P3	PVC	GY		AL-WWAK5P3-L/P00	8051134	8051135	8051136		
	4A	5P3.1	PUR	BK	•	AL-WWAK5P3.1-L/S370	8045917	8045918	8045919		
	4A	5P3.1	PUR	BK	•	AL-WWAK5P3.1-L/S400	8075541	8075542	8075543		
	4A	5P3.1	PUR	GY	•	AL-WWAK5P3.1-L/S370GY	8059948	8059949	8059950		
	4A	5P3.1	PUR	OG	•	AL-WWAK5P3.1-L/S7400	8058952	8058953	8058954		
	4A	5P3.1	PVC	BK	•	AL-WWAK5P3.1-L/P01BK	8081907	8081908	8081909		
4A	5P3.1	PVC	GY	•	AL-WWAK5P3.1-L/P01	8051346	8051347	8051348			
4A	5P3.1	PVC	GY		AL-WWAK5P3.1-L/P00	8051137	8051138	8051139			
 <p>延长电缆 母头, 弯型, M12, 保护套管带螺纹压头</p>	5	30V	4A	5P3	PUR	OG		AL-WWAK4.5P3-L/S7400	8084866	8085305	8085306
			4A	5P3.1	PUR	OG		AL-WWAK4.5P3.1-L/S7400	8084867	8085307	8085308
	4	250V	4A		PUR	BK	•	AL-WWAKG4-L/S370	8052829	8052830	8052831
			4A		PUR	BK	•	AL-WWAKG4-L/S400	8075520	8075521	8075522
			4A		PUR	GY	•	AL-WWAKG4-L/S370GY	8059092	8059093	8059094
			4A		PUR	OG	•	AL-WWAKG4-L/S7400	8059095	8059096	8059097
			4A		PVC	BK	•	AL-WWAKG4-L/P01BK	8082062	8082063	8082064
			4A		PVC	GY	•	AL-WWAKG4-L/P01	8052835	8052836	8052837
			4A		PVC	GY		AL-WWAKG4-L/P00	8052832	8052833	8052834

标准连接器的长度:2米,5米,或10米。中继电缆长度:1米,2米或5米。法兰面板安装的电线长度:0.5米(0.2米)。其他电缆,电线长度可按照客户要求定制。

	顶端				电缆			产品描述	L = 电缆长度*		
	针脚	最大电压	最大电流	LED	材料	颜色	UL		2m / 1m	5m / 2m	10m / 5m
 延长电缆 公头，直型，M12	3	250V	4A	PUR	BK	•	AL-WAS3-L/S370	8043804	8043805	8043806	
			4A	PUR	BK	•	AL-WAS3-L/S400	8075478	8075479	8075480	
			4A	PUR	GY	•	AL-WAS3-L/S370GY	8058955	8058956	8058957	
			4A	PUR	OG	•	AL-WAS3-L/S7400	8058964	8058965	8058966	
			4A	PVC	BK	•	AL-WAS3-L/P01BK	8081853	8081854	8081855	
			4A	PVC	GY	•	AL-WAS3-L/P01	8051256	8051257	8051258	
			4A	PVC	GY		AL-WAS3-L/P00	8051049	8051050	8051051	
	4	250V	4A	PUR	BK	•	AL-WAS4-L/S370	8043817	8043818	8043819	
			4A	PUR	BK	•	AL-WAS4-L/S400	8075499	8075500	8075501	
			4A	PUR	GY	•	AL-WAS4-L/S370GY	8058958	8058959	8058960	
			4A	PUR	OG	•	AL-WAS4-L/S7400	8058967	8058968	8058969	
			4A	PVC	BK	•	AL-WAS4-L/P01BK	8081865	8081866	8081867	
			4A	PVC	GY	•	AL-WAS4-L/P01	8051268	8051269	8051270	
			4A	PVC	GY		AL-WAS4-L/P00	8049339	8051058	8051059	
	4+PE	60V	4A	PUR	BK	•	AL-WAS5-L/S370	8046024	8046026	8046027	
			4A	PUR	BK	•	AL-WAS5-L/S400	8075532	8075533	8075534	
			4A	PUR	GY	•	AL-WAS5-L/S370GY	8058961	8058962	8058963	
			4A	PUR	OG	•	AL-WAS5-L/S7400	8058970	8058971	8058972	
			4A	PVC	BK	•	AL-WAS5-L/P01BK	8081877	8081878	8081879	
			4A	PVC	GY	•	AL-WAS5-L/P01	8051292	8051293	8051294	
			4A	PVC	GY		AL-WAS5-L/P00	8051083	8051084	8051085	
5	60V	4A	PUR	BK	•	AL-WAS4.5-L/S370	8043829	8043830	8043831		
		4A	PUR	BK	•	AL-WAS4.5-L/S400	8075547	8075548	8075549		
		4A	PUR	GY	•	AL-WAS4.5-L/S370GY	8092298	8092299	8092300		
		4A	PUR	OG		AL-WAS4.5-L/S7400	8084860	8085292	8085293		
		4A	PVC	GY	•	AL-WAS4.5-L/P01	8051280	8051281	8051282		
		4A	PVC	GY		AL-WAS4.5-L/P00	8051072	8051073	8049345		
8	30V	2A	PUR	BK	•	AL-WAS8-L/S370	8046909	8046910	8046911		
		2A	PUR	BK	•	AL-WAS8-L/S400	8075559	8075560	8075561		
		2A	PUR	GY	•	AL-WAS8-L/S370GY	8092334	8092335	8092336		
		2A	PVC	GY	•	AL-WAS8-L/P01	8051304	8051305	8051306		
		2A	PVC	GY		AL-WAS8-L/P00	8051095	8051096	8051097		

标准连接器的长度:2米,5米,或10米。中继电缆长度:1米,2米或5米。法兰面板安装的电线长度:0.5米(0.2米)。其他电缆,电线长度可按照客户要求定制。

	顶端				电缆			产品描述	L = 电缆长度*		
	针脚	最大电压	最大电流	LED	材料	颜色	UL		2m / 1m	5m / 2m	10m / 5m
 延长电缆 公头, 直型, M12	12	30V	1.5A		PUR	BK	•	AL-WAS12-L/S370	8046926	8046927	8046928
			1.5A		PUR	BK	•	AL-WAS12-L/S400	8075571	8075572	8075573
			1.5A		PUR	GY	•	AL-WAS12-L/S370GY	8092361	8092362	8092363
			1.5A		PVC	GY	•	AL-WAS12-L/P01	8051316	8051317	8051318
			1.5A		PVC	GY		AL-WAS12-L/P00	8051107	8051108	8051109
 延长电缆 公头, 直型, M12, 保护套管带螺纹压头	4	250V	4A		PUR	BK	•	AL-WASG4-L/S370	8052838	8052839	8052840
			4A		PUR	BK	•	AL-WASG4-L/S400	8075502	8075503	8075504
			4A		PUR	GY	•	AL-WASG4-L/S370GY	8059098	8059099	8059100
			4A		PUR	OG	•	AL-WASG4-L/S7400	8059101	8059102	8059103
			4A		PVC	BK	•	AL-WASG4-L/P01BK	8082065	8082066	8082067
			4A		PVC	GY	•	AL-WASG4-L/P01	8052844	8052845	8052846
			4A		PVC	GY		AL-WASG4-L/P00	8052841	8052842	8052843

标准连接器的长度:2米,5米,或10米。中继电缆长度:1米,2米或5米。法兰面板安装的电线长度:0.5米(0.2米)。其他电缆,电线长度可按照客户要求定制。

	顶端				电缆			产品描述	L = 电缆长度*		
	针脚	最大电压	最大电流	LED	材料	颜色	UL		2m / 1m	5m / 2m	10m / 5m
 延长电缆 公头，弯型，M12	3	250V	4A	PUR	BK	•	AL-WWAS3-L/S370	8043808	8043809	8043810	
			4A	PUR	BK	•	AL-WWAS3-L/S400	8075487	8075488	8075489	
			4A	PUR	GY	•	AL-WWAS3-L/S370GY	8058973	8058974	8058975	
			4A	PUR	OG	•	AL-WWAS3-L/S7400	8058982	8058983	8058984	
			4A	PVC	BK	•	AL-WWAS3-L/P01BK	8081856	8081857	8081858	
			4A	PVC	GY	•	AL-WWAS3-L/P01	8051259	8051260	8051261	
			4A	PVC	GY		AL-WWAS3-L/P00	8051052	8051053	8051054	
	4	250V	4A	PUR	BK	•	AL-WWAS4-L/S370	8043820	8043821	8043822	
			4A	PUR	BK	•	AL-WWAS4-L/S400	8075523	8075524	8075525	
			4A	PUR	GY	•	AL-WWAS4-L/S370GY	8058976	8058977	8058978	
			4A	PUR	OG	•	AL-WWAS4-L/S7400	8058985	8058986	8058987	
			4A	PVC	BK	•	AL-WWAK4-L/P01BK	8081862	8081863	8081864	
			4A	PVC	BK	•	AL-WWAS4-L/P01BK	8081868	8081869	8081870	
			4A	PVC	GY	•	AL-WWAS4-L/P01	8051271	8051272	8051273	
4+PE	60V	4A	PVC	GY		AL-WWAS4-L/P00	8051869	8051870	8051871		
		4A	PUR	BK	•	AL-WWAS5-L/S370	8046028	8046029	8046030		
		4A	PUR	BK	•	AL-WWAS5-L/S400	8075544	8075545	8075546		
		4A	PUR	GY	•	AL-WWAS5-L/S370GY	8058979	8058980	8058981		
		4A	PUR	OG	•	AL-WWAS5-L/S7400	8058988	8058989	8058990		
		4A	PVC	BK	•	AL-WWAS5-L/P01BK	8081880	8081881	8081882		
		4A	PVC	GY	•	AL-WWAS5-L/P01	8051295	8051296	8051297		
5	60V	4A	PVC	GY		AL-WWAS5-L/P00	8051086	8051087	8051088		
		4A	PUR	BK	•	AL-WWAS4.5-L/S370	8043832	8043833	8043834		
		4A	PUR	BK	•	AL-WWAS4.5-L/S400	8075553	8075554	8075555		
		4A	PUR	GY	•	AL-WWAS4.5-L/S370GY	8092307	8092308	8092309		
		4A	PUR	OG		AL-WWAS4.5-L/S7400	8084861	8085294	8085295		
		4A	PVC	GY	•	AL-WWAS4.5-L/P01	8051283	8051284	8051285		
8	30V	4A	PVC	GY		AL-WWAS4.5-L/P00	8051074	8051075	8051076		
		2A	PUR	BK	•	AL-WWAS8-L/S370	8046912	8046913	8046914		
		2A	PUR	BK	•	AL-WWAS8-L/S400	8075565	8075566	8075567		
		2A	PUR	GY	•	AL-WWAS8-L/S370GY	8092340	8092341	8092342		
		2A	PVC	GY	•	AL-WWAS8-L/P01	8051307	8051308	8051309		
2A	PVC	GY		AL-WWAS8-L/P00	8051098	8051099	8051100				

标准连接器的长度:2米,5米,或10米。中继电缆长度:1米,2米或5米。法兰面板安装的电线长度:0.5米(0.2米)。其他电缆,电线长度可按照客户要求定制。

	顶端				电缆			产品描述	L = 电缆长度*		
	针脚	最大电压	最大电流	LED	材料	颜色	UL		2m / 1m	5m / 2m	10m / 5m
 延长电缆 公头, 弯型, M12	12	30V	1.5A		PUR	BK	•	AL-WWAS12-L/S370	8046929	8046930	8046931
			1.5A		PUR	BK	•	AL-WWAS12-L/S400	8075577	8075578	8075579
			1.5A		PUR	GY	•	AL-WWAS12-L/S370GY	8092367	8092368	8092369
			1.5A		PVC	GY	•	AL-WWAS12-L/P01	8051319	8051321	8051320
			1.5A		PVC	GY		AL-WWAS12-L/P00	8051110	8051111	8051112
			4A		PUR	BK	•	AL-WWASG4-L/S370	8052847	8052848	8052849
 延长电缆 公头, 弯型, M12, 保护套管带螺纹压头	4	250V	4A		PUR	BK	•	AL-WWASG4-L/S400	8075526	8075527	8075528
			4A		PUR	GY	•	AL-WWASG4-L/S370GY	8059104	8059105	8059106
			4A		PUR	OG	•	AL-WWASG4-L/S7400	8059107	8059108	8059109
			4A		PVC	BK	•	AL-WWASG4-L/P01BK	8082068	8082069	8082070
			4A		PVC	GY	•	AL-WWASG4-L/P01	8052853	8052854	8052855
			4A		PVC	GY		AL-WWASG4-L/P00	8052850	8052851	8052852

标准连接器的长度:2米,5米,或10米。中继电缆长度:1米,2米或5米。法兰面板安装的电线长度:0.5米(0.2米)。其他电缆,电线长度可按照客户要求定制。

	顶端				电缆			产品描述	L = 电缆长度*		
	针脚	最大电压	最大电流	LED	材料	颜色	UL		2m / 1m	5m / 2m	10m / 5m
 <p>连接电缆 母头, 直型, M12 公头, 直型, M12</p>	3	250V	4A		PUR	BK	•	AL-WAK3-L-AL-WAS3/S370	8044858	8044029	8044030
			4A		PUR	GY	•	AL-WAK3-L-AL-WAS3/S370GY	8058889	8058890	8058891
			4A		PUR	OG	•	AL-WAK3-L-AL-WAS3/S7400	8058921	8058898	8058899
			4A		PVC	BK	•	AL-WAK3-L-AL-WAS3/P01BK	8081952	8081953	8081954
			4A		PVC	GY	•	AL-WAK3-L-AL-WAS3/P01	8051667	8051668	8051669
			4A		PVC	GY		AL-WAK3-L-AL-WAS3/P00	8051459	8051460	8051461
	4	250V	4A		PUR	BK	•	AL-WAK4-L-AL-WAS4/S370	8044813	8044041	8044042
			4A		PUR	GY	•	AL-WAK4-L-AL-WAS4/S370GY	8058892	8058893	8058894
			4A		PUR	OG	•	AL-WAK4-L-AL-WAS4/S7400	8057296	8057322	8057324
			4A		PVC	BK	•	AL-WAK4-L-AL-WAS4/P01BK	8081964	8081965	8081966
			4A		PVC	GY	•	AL-WAK4-L-AL-WAS4/P01	8051679	8051680	8051681
			4A		PVC	GY		AL-WAK4-L-AL-WAS4/P00	8051471	8051472	8051473
	4+PE	60V	4A		PUR	BK	•	AL-WAK5-L-AL-WAS5/S370	8046647	8046031	8046032
			4A		PUR	GY	•	AL-WAK5-L-AL-WAS5/S370GY	8058895	8058896	8058897
			4A		PUR	OG	•	AL-WAK5-L-AL-WAS5/S7400	8058900	8058901	8058902
			4A		PVC	BK	•	AL-WAK5-L-AL-WAS5/P01BK	8081976	8081977	8081978
			4A		PVC	GY	•	AL-WAK5-L-AL-WAS5/P01	8051703	8051704	8051705
			4A		PVC	GY		AL-WAK5-L-AL-WAS5/P00	8051495	8051496	8051497
	5	60V	4A		PUR	BK	•	AL-WAK4.5-L-AL-WAS4.5/S370	8050226	8044053	8044054
			4A		PUR	GY	•	AL-WAK4.5-L-AL-WAS4.5/S370GY	8092310	8092311	8092312
			4A		PUR	OG		AL-WAK4.5-L-AL-WAS4.5/S7400	8085296	8084862	8085297
			4A		PVC	GY	•	AL-WAK4.5-L-AL-WAS4.5/P01	8051691	8051692	8051693
			4A		PVC	GY		AL-WAK4.5-L-AL-WAS4.5/P00	8051483	8051484	8051485
	8	30V	2A		PUR	BK	•	AL-WAK8-L-AL-WAS8/S370	8049781	8046932	8046933
2A				PUR	GY	•	AL-WAK8-L-AL-WAS8/S370GY	8092343	8092344	8092345	
2A				PVC	GY	•	AL-WAK8-L-AL-WAS8/P01	8051715	8051716	8051717	
2A				PVC	GY		AL-WAK8-L-AL-WAS8/P00	8051507	8051508	8051509	
12	30V	1.5A		PUR	BK	•	AL-WAK12-L-AL-WAS12/S370	8051872	8046944	8046945	
		1.5A		PUR	GY	•	AL-WAK12-L-AL-WAS12/S370GY	8092370	8092371	8092372	
		1.5A		PVC	GY	•	AL-WAK12-L-AL-WAS12/P01	8051727	8051728	8051729	
		1.5A		PVC	GY		AL-WAK12-L-AL-WAS12/P00	8051519	8051520	8051521	

标准连接器的长度:2米,5米,或10米。中继电缆长度:1米,2米或5米。法兰面板安装的电线长度:0.5米(0.2米)。其他电缆,电线长度可按照客户要求定制。



	顶端				电缆			产品描述	L = 电缆长度*		
	针脚	最大电压	最大电流	LED	材料	颜色	UL		2m / 1m	5m / 2m	10m / 5m
 <p>连接电缆 母头, 直型, M12 公头, 弯型, M12</p>	3	250V	4A		PUR	BK	•	AL-WAK3-L-AL-WWAS3/S370	8051873	8044035	8044036
			4A		PUR	GY	•	AL-WAK3-L-AL-WWAS3/S370GY	8058903	8058904	8058905
			4A		PUR	OG	•	AL-WAK3-L-AL-WWAS3/S7400	8058912	8058913	8058914
			4A		PVC	BK	•	AL-WAK3-L-AL-WWAS3/P01BK	8081958	8081959	8081960
			4A		PVC	GY	•	AL-WAK3-L-AL-WWAS3/P01	8051673	8051674	8051675
			4A		PVC	GY		AL-WAK3-L-AL-WWAS3/P00	8051465	8051466	8051467
	4	250V	4A		PUR	BK	•	AL-WAK4-L-AL-WWAS4/S370	8051874	8044047	8044048
			4A		PUR	GY	•	AL-WAK4-L-AL-WWAS4/S370GY	8058906	8058907	8058908
			4A		PUR	OG	•	AL-WAK4-L-AL-WWAS4/S7400	8058915	8058916	8058917
			4A		PVC	BK	•	AL-WAK4-L-AL-WWAS4/P01BK	8081970	8081971	8081972
			4A		PVC	GY	•	AL-WAK4-L-AL-WWAS4/P01	8051685	8051686	8051687
			4A		PVC	GY		AL-WAK4-L-AL-WWAS4/P00	8051477	8051478	8051479
	4+PE	60V	4A		PUR	BK	•	AL-WAK5-L-AL-WWAS5/S370	8046056	8046037	8046038
			4A		PUR	GY	•	AL-WAK5-L-AL-WWAS5/S370GY	8058909	8058910	8058911
			4A		PUR	OG	•	AL-WAK5-L-AL-WWAS5/S7400	8058918	8058919	8058920
			4A		PVC	BK	•	AL-WAK5-L-AL-WWAS5/P01BK	8081982	8081983	8081984
			4A		PVC	GY	•	AL-WAK5-L-AL-WWAS5/P01	8051709	8051710	8051711
			4A		PVC	GY		AL-WAK5-L-AL-WWAS5/P00	8051501	8051502	8051503
	5	60V	4A		PUR	BK	•	AL-WAK4.5-L-AL-WWAS4.5/S370	8051875	8044059	8044060
			4A		PUR	GY	•	AL-WAK4.5-L-AL-WWAS4.5/S370GY	8092313	8092314	8092315
			4A		PUR	OG		AL-WAK4.5-L-AL-WWAS4.5/S7400	8085298	8084863	8085300
			4A		PVC	GY	•	AL-WAK4.5-L-AL-WWAS4.5/P01	8051697	8051698	8051699
			4A		PVC	GY		AL-WAK4.5-L-AL-WWAS4.5/P00	8051489	8051490	8051491
	8	30V	2A		PUR	BK	•	AL-WAK8-L-AL-WWAS8/S370	8051876	8046938	8046939
2A				PUR	GY	•	AL-WAK8-L-AL-WWAS8/S370GY	8092346	8092347	8092348	
2A				PVC	GY	•	AL-WAK8-L-AL-WWAS8/P01	8051721	8051722	8051723	
2A				PVC	GY		AL-WAK8-L-AL-WWAS8/P00	8051513	8051514	8051515	
12	30V	1.5A		PUR	BK	•	AL-WAK12-L-AL-WWAS12/S370	8051877	8046950	8046951	
		1.5A		PUR	GY	•	AL-WAK12-L-AL-WWAS12/S370GY	8092373	8092374	8092375	
		1.5A		PVC	GY	•	AL-WAK12-L-AL-WWAS12/P01	8051733	8051734	8051735	
		1.5A		PVC	GY		AL-WAK12-L-AL-WWAS12/P00	8051525	8051526	8051527	

标准连接器的长度:2米,5米,或10米。中继电缆长度:1米,2米或5米。法兰面板安装的电线长度:0.5米(0.2米)。其他电缆,电线长度可按照客户要求定制。



	顶端				电缆			产品描述	L = 电缆长度*		
	针脚	最大电压	最大电流	LED	材料	颜色	UL		2m / 1m	5m / 2m	10m / 5m
 <p>连接电缆 母头, 直型, M12, 带LED 公头, 直型, M12</p>	3	30V	4A	3P2	PUR	BK	•	AL-WAK3P2-L-AL-WAS3/S370	8052751	8049895	8049896
			4A	3P2	PUR	GY	•	AL-WAK3P2-L-AL-WAS3/S370GY	8059034	8059035	8059036
			4A	3P2	PUR	OG	•	AL-WAK3P2-L-AL-WAS3/S7400	8059040	8059041	8059042
			4A	3P2	PVC	BK	•	AL-WAK3P2-L-AL-WAS3/P01BK	8082059	8082060	8082061
			4A	3P2	PVC	GY	•	AL-WAK3P2-L-AL-WAS3/P01	8052749	8052748	8052750
			4A	3P2	PVC	GY		AL-WAK3P2-L-AL-WAS3/P00	8052745	8052747	8052746
	4	30V	4A	4P2	PUR	BK	•	AL-WAK4P2-L-AL-WAS4/S370	8049946	8052064	8052065
			4A	4P2	PUR	GY	•	AL-WAK4P2-L-AL-WAS4/S370GY	8059037	8059038	8059039
			4A	4P2	PUR	OG	•	AL-WAK4P2-L-AL-WAS4/S7400	8059043	8059044	8059045
			4A	4P2	PVC	BK	•	AL-WAK4P2-L-AL-WAS4/P01BK	8082028	8082029	8082030
			4A	4P2	PVC	GY	•	AL-WAK4P2-L-AL-WAS4/P01	8052523	8052524	8052525
			4A	4P2	PVC	GY		AL-WAK4P2-L-AL-WAS4/P00	8052520	8052521	8052522



标准连接器的长度:2米,5米,或10米。中继电缆长度:1米,2米或5米。法兰面板安装的电线长度:0.5米(0.2米)。其他电缆,电线长度可按照客户要求定制。

	顶端				电缆			产品描述	L = 电缆长度*		
	针脚	最大电压	最大电流	LED	材料	颜色	UL		2m / 1m	5m / 2m	10m / 5m
 连接电缆 母头, 弯型, M12  公头, 直型, M12	3	250V	4A	PUR	BK	•	AL-WWAK3-L-AL-WAS3/S370	8047133	8044038	8044039	
			4A	PUR	GY	•	AL-WWAK3-L-AL-WAS3/S370GY	8058998	8058999	8059000	
			4A	PUR	OG	•	AL-WWAK3-L-AL-WAS3/S7400	8059007	8059008	8059009	
			4A	PVC	BK	•	AL-WWAK3-L-AL-WAS3/P01BK	8081961	8081962	8081963	
			4A	PVC	GY	•	AL-WWAK3-L-AL-WAS3/P01	8051676	8051677	8051678	
			4A	PVC	GY		AL-WWAK3-L-AL-WAS3/P00	8051468	8051469	8051470	
	4	250V	4A	PUR	BK	•	AL-WWAK4-L-AL-WAS4/S370	8044664	8044050	8044051	
			4A	PUR	GY	•	AL-WWAK4-L-AL-WAS4/S370GY	8059001	8059002	8059003	
			4A	PUR	OG	•	AL-WWAK4-L-AL-WAS4/S7400	8059010	8059011	8059012	
			4A	PVC	BK	•	AL-WWAK4-L-AL-WAS4/P01BK	8081973	8081974	8081975	
			4A	PVC	GY	•	AL-WWAK4-L-AL-WAS4/P01	8051688	8051689	8051690	
			4A	PVC	GY		AL-WWAK4-L-AL-WAS4/P00	8051480	8051481	8051482	
	4+PE	60V	4A	PUR	BK	•	AL-WWAK5-L-AL-WAS5/S370	8046055	8046040	8046041	
			4A	PUR	GY	•	AL-WWAK5-L-AL-WAS5/S370GY	8059004	8059005	8059006	
			4A	PUR	OG	•	AL-WWAK5-L-AL-WAS5/S7400	8059013	8059014	8059015	
			4A	PVC	BK	•	AL-WWAK5-L-AL-WAS5/P01BK	8081985	8081986	8081987	
			4A	PVC	GY	•	AL-WWAK5-L-AL-WAS5/P01	8051712	8051713	8051714	
			4A	PVC	GY		AL-WWAK5-L-AL-WAS5/P00	8051504	8051505	8051506	
	5	60V	4A	PUR	BK	•	AL-WWAK4.5-L-AL-WAS4.5/S370	8050444	8044062	8044063	
			4A	PUR	GY	•	AL-WWAK4.5-L-AL-WAS4.5/S370GY	8092316	8092317	8092302	
			4A	PUR	OG		AL-WWAK4.5-L-AL-WAS4.5/S7400	8085301	8084864	8085302	
			4A	PVC	GY	•	AL-WWAK4.5-L-AL-WAS4.5/P01	8051700	8051701	8051702	
			4A	PVC	GY		AL-WWAK4.5-L-AL-WAS4.5/P00	8051492	8051493	8051494	
	8	30V	2A	PUR	BK	•	AL-WWAK8-L-AL-WAS8/S370	8048889	8046941	8046942	
2A			PUR	GY	•	AL-WWAK8-L-AL-WAS8/S370GY	8092349	8092350	8092351		
2A			PVC	GY	•	AL-WWAK8-L-AL-WAS8/P01	8051724	8051725	8051726		
2A			PVC	GY		AL-WWAK8-L-AL-WAS8/P00	8051516	8051517	8051518		
12	30V	1.5A	PUR	BK	•	AL-WWAK12-L-AL-WAS12/S370	8051878	8046953	8046954		
		1.5A	PUR	GY	•	AL-WWAK12-L-AL-WAS12/S370GY	8092376	8092377	8092378		
		1.5A	PVC	GY	•	AL-WWAK12-L-AL-WAS12/P01	8051736	8051737	8051738		
		1.5A	PVC	GY		AL-WWAK12-L-AL-WAS12/P00	8051528	8051529	8051530		



标准连接器的长度:2米,5米,或10米。中继电缆长度:1米,2米或5米。法兰面板安装的电线长度:0.5米(0.2米)。其他电缆,电线长度可按照客户要求定制。

	顶端				电缆			产品描述	L = 电缆长度*		
	针脚	最大电压	最大电流	LED	材料	颜色	UL		2m / 1m	5m / 2m	10m / 5m
 <p>连接电缆 母头, 弯型, M12 公头, 弯型, M12</p>	3	250V	4A		PUR	BK	•	AL-WWAK3-L-AL-WWAS3/S370	8049108	8044032	8044033
			4A		PUR	GY	•	AL-WWAK3-L-AL-WWAS3/S370GY	8059016	8059017	8059018
			4A		PUR	OG	•	AL-WWAK3-L-AL-WWAS3/S7400	8059025	8059026	8059027
			4A		PVC	BK	•	AL-WWAK3-L-AL-WWAS3/P01BK	8081955	8081956	8081957
			4A		PVC	GY	•	AL-WWAK3-L-AL-WWAS3/P01	8051671	8051670	8051672
			4A		PVC	GY		AL-WWAK3-L-AL-WWAS3/P00	8051462	8051463	8051464
	4	250V	4A		PUR	BK	•	AL-WWAK4-L-AL-WWAS4/S370	8051879	8044044	8044045
			4A		PUR	GY	•	AL-WWAK4-L-AL-WWAS4/S370GY	8059019	8059020	8059021
			4A		PUR	OG	•	AL-WWAK4-L-AL-WWAS4/S7400	8059028	8059029	8059030
			4A		PVC	BK	•	AL-WWAK4-L-AL-WWAS4/P01BK	8081967	8081968	8081969
			4A		PVC	GY	•	AL-WWAK4-L-AL-WWAS4/P01	8051682	8051683	8051684
			4A		PVC	GY		AL-WWAK4-L-AL-WWAS4/P00	8051474	8051475	8051476
	4+PE	60V	4A		PUR	BK	•	AL-WWAK5-L-AL-WWAS5/S370	8051881	8046034	8046035
			4A		PUR	GY	•	AL-WWAK5-L-AL-WWAS5/S370GY	8059022	8059023	8059024
			4A		PUR	OG	•	AL-WWAK5-L-AL-WWAS5/S7400	8059031	8059032	8059033
			4A		PVC	BK	•	AL-WWAK5-L-AL-WWAS5/P01BK	8081979	8081980	8081981
			4A		PVC	GY	•	AL-WWAK5-L-AL-WWAS5/P01	8051706	8051707	8051708
			4A		PVC	GY		AL-WWAK5-L-AL-WWAS5/P00	8051498	8051499	8051500
	5	60V	4A		PUR	BK	•	AL-WWAK4.5-L-AL-WWAS4.5/S370	8051880	8044056	8044057
			4A		PUR	GY	•	AL-WWAK4.5-L-AL-WWAS4.5/S370GY	8092329	8092330	8092303
			4A		PUR	OG		AL-WWAK4.5-L-AL-WWAS4.5/S7400	8085303	8084865	8085304
			4A		PVC	GY	•	AL-WWAK4.5-L-AL-WWAS4.5/P01	8051694	8051695	8051696
			4A		PVC	GY		AL-WWAK4.5-L-AL-WWAS4.5/P00	8051486	8051487	8051488
	8	30V	2A		PUR	BK	•	AL-WWAK8-L-AL-WWAS8/S370	8051882	8046935	8046936
2A				PUR	GY	•	AL-WWAK8-L-AL-WWAS8/S370GY	8092354	8092355	8092356	
2A				PVC	GY	•	AL-WWAK8-L-AL-WWAS8/P01	8051718	8051719	8051720	
2A				PVC	GY		AL-WWAK8-L-AL-WWAS8/P00	8051510	8051511	8051512	
12	30V	1.5A		PUR	BK	•	AL-WWAK12-L-AL-WWAS12/S370	8051883	8046947	8046948	
		1.5A		PUR	GY	•	AL-WWAK12-L-AL-WWAS12/S370GY	8092380	8092381	8092382	
		1.5A		PVC	GY	•	AL-WWAK12-L-AL-WWAS12/P01	8051730	8051731	8051732	
		1.5A		PVC	GY		AL-WWAK12-L-AL-WWAS12/P00	8051522	8051523	8051524	

标准连接器的长度:2米,5米,或10米。中继电缆长度:1米,2米或5米。法兰面板安装的电线长度:0.5米(0.2米)。其他电缆,电线长度可按照客户要求定制。

	顶端				电缆			产品描述	L = 电缆长度*		
	针脚	最大电压	最大电流	LED	材料	颜色	UL		2m / 1m	5m / 2m	10m / 5m
 连接电缆 母头, 弯型, M12, 带LED  公头, 直型, M12	3	30V	4A	3P2	PUR	BK	•	AL-WWAK3P2-L-AL-WAS3/S370	8048160	8045579	8045503
			4A	3P2	PUR	GY	•	AL-WWAK3P2-L-AL-WAS3/S370GY	8059046	8059047	8059048
			4A	3P2	PUR	OG	•	AL-WWAK3P2-L-AL-WAS3/S7400	8059067	8059068	8059069
			4A	3P2	PVC	BK	•	AL-WWAK3P2-L-AL-WAS3/P01BK	8081991	8081992	8081993
			4A	3P2	PVC	GY	•	AL-WWAK3P2-L-AL-WAS3/P01	8051745	8051746	8051747
			4A	3P2	PVC	GY		AL-WWAK3P2-L-AL-WAS3/P00	8051537	8051538	8051539
			4	30V	4A	4P2	PUR	BK	•	AL-WWAK4P2-L-AL-WAS4/S370	8043925
4A	4P2	PUR			GY	•	AL-WWAK4P2-L-AL-WAS4/S370GY	8059049	8059050	8059051	
4A	4P2	PUR			OG	•	AL-WWAK4P2-L-AL-WAS4/S7400	8059070	8059071	8059072	
4A	4P2	PVC			BK	•	AL-WWAK4P2-L-AL-WAS4/P01BK	8081994	8081995	8081996	
4A	4P2	PVC			GY	•	AL-WWAK4P2-L-AL-WAS4/P01	8051748	8051749	8051750	
4A	4P2	PVC			GY		AL-WWAK4P2-L-AL-WAS4/P00	8051540	8051541	8051542	
4A	4P3	PUR			BK	•	AL-WWAK4P3-L-AL-WAS4/S370	8049739	8045923	8045924	
4A	4P3	PUR			GY	•	AL-WWAK4P3-L-AL-WAS4/S370GY	8059052	8059053	8059054	
4A	4P3	PUR			OG	•	AL-WWAK4P3-L-AL-WAS4/S7400	8058054	8057297	8057321	
4A	4P3	PVC			BK	•	AL-WWAK4P3-L-AL-WAS4/P01BK	8081997	8081998	8081999	
4A	4P3	PVC			GY	•	AL-WWAK4P3-L-AL-WAS4/P01	8051751	8051752	8051753	
4A	4P3	PVC			GY		AL-WWAK4P3-L-AL-WAS4/P00	8051543	8051545	8051544	
4A	4P3.1	PUR			BK	•	AL-WWAK4P3.1-L-AL-WAS4/S370	8051884	8045926	8045927	
4A	4P3.1	PUR			GY	•	AL-WWAK4P3.1-L-AL-WAS4/S370GY	8059055	8059056	8059057	
4A	4P3.1	PUR			OG	•	AL-WWAK4P3.1-L-AL-WAS4/S7400	8059073	8059074	8059075	
4A	4P3.1	PVC			BK	•	AL-WWAK4P3.1-L-AL-WAS4/P01BK	8082000	8082001	8082002	
4A	4P3.1	PVC			GY	•	AL-WWAK4P3.1-L-AL-WAS4/P01	8051754	8051755	8051756	
4A	4P3.1	PVC			GY		AL-WWAK4P3.1-L-AL-WAS4/P00	8051546	8051547	8051548	
4A	4P3.2	PUR			BK	•	AL-WWAK4P3.2-L-AL-WAS4/S370	8048140	8045929	8045930	
4A	4P3.2	PUR			GY	•	AL-WWAK4P3.2-L-AL-WAS4/S370GY	8059058	8059059	8059060	
4A	4P3.2	PUR			OG	•	AL-WWAK4P3.2-L-AL-WAS4/S7400	8059076	8059077	8059078	
4A	4P3.2	PVC			BK	•	AL-WWAK4P3.2-L-AL-WAS4/P01BK	8082004	8082005	8082006	
4A	4P3.2	PVC			GY	•	AL-WWAK4P3.2-L-AL-WAS4/P01	8051757	8051758	8051759	
4A	4P3.2	PVC			GY		AL-WWAK4P3.2-L-AL-WAS4/P00	8051549	8051550	8051551	

标准连接器的长度:2米,5米,或10米。中继电缆长度:1米,2米或5米。法兰面板安装的电线长度:0.5米(0.2米)。其他电缆,电线长度可按照客户要求定制。

	顶端				电缆			产品描述	L = 电缆长度*				
	针脚	最大电压	最大电流	LED	材料	颜色	UL		2m / 1m	5m / 2m	10m / 5m		
 连接电缆 母头, 弯型, M12, 带LED  公头, 直型, M12	4+PE	30V	4A	5P3	PUR	BK	•	AL-WWAK5P3-L-AL-WAS5/S370	8051885	8045581	8045583		
			4A	5P3	PUR	GY	•	AL-WWAK5P3-L-AL-WAS5/S370GY	8059061	8059062	8059063		
			4A	5P3	PUR	OG	•	AL-WWAK5P3-L-AL-WAS5/S7400	8059079	8059080	8059081		
			4A	5P3	PVC	BK	•	AL-WWAK5P3-L-AL-WAS5/P01BK	8082007	8082008	8082009		
			4A	5P3	PVC	GY	•	AL-WWAK5P3-L-AL-WAS5/P01	8051760	8051761	8051762		
			4A	5P3	PVC	GY	•	AL-WWAK5P3-L-AL-WAS5/P00	8051552	8051553	8051554		
			4A	5P3.1	PUR	BK	•	AL-WWAK5P3.1-L-AL-WAS5/S370	8045017	8045661	8045662		
			4A	5P3.1	PUR	GY	•	AL-WWAK5P3.1-L-AL-WAS5/S370GY	8059064	8059065	8059066		
			4A	5P3.1	PUR	OG	•	AL-WWAK5P3.1-L-AL-WAS5/S7400	8059082	8059083	8059084		
			4A	5P3.1	PVC	BK	•	AL-WWAK5P3.1-L-AL-WAS5/P01BK	8082010	8082011	8082012		
			4A	5P3.1	PVC	GY	•	AL-WWAK5P3.1-L-AL-WAS5/P01	8051763	8051764	8051765		
			4A	5P3.1	PVC	GY	•	AL-WWAK5P3.1-L-AL-WAS5/P00	8051555	8051556	8051557		
			5	30V	4A	4.5P3	PUR	OG	•	AL-WWAK4.5P3-L-AL-WAS4.5/S7400	8085309	8084868	8085310
					4A	4.5P3.1	PUR	OG	•	AL-WWAK4.5P3.1-L-AL-WAS4.5/S7400	8085311	8084869	8085312
3	250V	4A		PUR	BK	•	AL-WAKS3-L/S370	8046217	8046218	8046219			
		4A		PUR	GY	•	AL-WAKS3-L/S370GY	8091539	8091540	8091541			
		4A		PVC	GY	•	AL-WAKS3-L/P01	8051374	8051375	8051376			
		4A		PVC	GY	•	AL-WAKS3-L/P00	8051164	8051165	8051166			
4	250V	4A		PUR	BK	•	AL-WAKS4-L/S370	8046229	8046230	8046231			
		4A		PUR	GY	•	AL-WAKS4-L/S370GY	8091588	8091589	8091590			
		4A		PVC	GY	•	AL-WAKS4-L/P01	8051386	8051387	8051388			
		4A		PVC	GY	•	AL-WAKS4-L/P00	8051176	8051177	8051178			
5	60V	4A		PUR	BK	•	AL-WAKS4.5-L/S370	8045557	8046239	8046240			
		4A		PUR	GY	•	AL-WAKS4.5-L/S370GY	8092192	8092193	8092194			
		4A		PVC	GY	•	AL-WAKS4.5-L/P01	8051398	8051399	8051400			
		4A		PVC	GY	•	AL-WAKS4.5-L/P00	8051188	8051189	8051190			
8	30V	2A		PUR	BK	•	AL-WAKS8-L/S370	8046990	8046991	8046992			
		2A		PUR	GY	•	AL-WAKS8-L/S370GY	8092218	8092219	8092220			
		2A		PVC	GY	•	AL-WAKS8-L/P01	8051410	8051411	8051412			
		2A		PVC	GY	•	AL-WAKS8-L/P00	8051200	8051201	8051202			
12	30V	1.5A		PUR	BK	•	AL-WAKS12-L/S370	8047001	8047002	8047003			
		1.5A		PUR	GY	•	AL-WAKS12-L/S370GY	8092268	8092269	8092270			
		1.5A		PVC	GY	•	AL-WAKS12-L/P01	8051422	8051423	8051424			
		1.5A		PVC	GY	•	AL-WAKS12-L/P00	8051212	8051213	8051214			

标准连接器的长度:2米,5米,或10米。中继电缆长度:1米,2米或5米。法兰面板安装的电线长度:0.5米(0.2米)。其他电缆,电线长度可按照客户要求定制。

	顶端				电缆			产品描述	L = 电缆长度*		
	针脚	最大电压	最大电流	LED	材料	颜色	UL		2m / 1m	5m / 2m	10m / 5m
 <p>延长电缆 母头, 弯型, M12 屏蔽</p>	3	250V	4A		PUR	BK	•	AL-WWAKS3-L/S370	8046220	8046221	8046222
			4A		PUR	GY	•	AL-WWAKS3-L/S370GY	8091545	8091546	8091547
			4A		PVC	GY	•	AL-WWAKS3-L/P01	8051377	8051378	8051379
			4A		PVC	GY		AL-WWAKS3-L/P00	8051167	8051168	8051169
	4	250V	4A		PUR	BK	•	AL-WWAKS4-L/S370	8046232	8045279	8045280
			4A		PUR	GY	•	AL-WWAKS4-L/S370GY	8091599	8091600	8091601
			4A		PVC	GY	•	AL-WWAKS4-L/P01	8051389	8051390	8051391
			4A		PVC	GY		AL-WWAKS4-L/P00	8051179	8051180	8051181
	5	60V	4A		PUR	BK	•	AL-WWAKS4.5-L/S370	8045558	8046242	8046243
			4A		PUR	GY	•	AL-WWAKS4.5-L/S370GY	8092198	8092199	8092200
			4A		PVC	GY	•	AL-WWAKS4.5-L/P01	8051401	8051402	8051403
			4A		PVC	GY		AL-WWAKS4.5-L/P00	8051191	8051192	8051193
	8	30V	2A		PUR	BK	•	AL-WWAKS8-L/S370	8046993	8046994	8046995
			2A		PUR	GY	•	AL-WWAKS8-L/S370GY	8092250	8092251	8092252
			2A		PVC	GY	•	AL-WWAKS8-L/P01	8051413	8051414	8051415
			2A		PVC	GY		AL-WWAKS8-L/P00	8051203	8051204	8051205
12	30V	1.5A		PUR	BK	•	AL-WWAKS12-L/S370	8047004	8047005	8047006	
		1.5A		PUR	GY	•	AL-WWAKS12-L/S370GY	8092277	8092278	8092279	
		1.5A		PVC	GY	•	AL-WWAKS12-L/P01	8051425	8051426	8051427	
		1.5A		PVC	GY		AL-WWAKS12-L/P00	8051216	8051217	8051218	

标准连接器的长度:2米,5米,或10米。中继电缆长度:1米,2米或5米。法兰面板安装的电线长度:0.5米(0.2米)。其他电缆,电线长度可按照客户要求定制。

	顶端				电缆			产品描述	L = 电缆长度*		
	针脚	最大电压	最大电流	LED	材料	颜色	UL		2m / 1m	5m / 2m	10m / 5m
 延长电缆 公头, 直型, M12 屏蔽	3	250V	4A		PUR	BK	•	AL-WASS3-L/S370	8046223	8046224	8046225
			4A		PUR	GY	•	AL-WASS3-L/S370GY	8091542	8091543	8091544
			4A		PVC	GY	•	AL-WASS3-L/P01	8051380	8051381	8051382
			4A		PVC	GY		AL-WASS3-L/P00	8051170	8051171	8051172
	4	250V	4A		PUR	BK	•	AL-WASS4-L/S370	8046233	8046234	8046235
			4A		PUR	GY	•	AL-WASS4-L/S370GY	8091591	8091592	8091593
			4A		PVC	GY	•	AL-WASS4-L/P01	8051392	8051393	8051394
			4A		PVC	GY		AL-WASS4-L/P00	8051182	8051183	8051184
	5	60V	4A		PUR	BK	•	AL-WASS4.5-L/S370	8045559	8046244	8046245
			4A		PUR	GY	•	AL-WASS4.5-L/S370GY	8092195	8092196	8092197
			4A		PVC	GY	•	AL-WASS4.5-L/P01	8051404	8051405	8051406
			4A		PVC	GY		AL-WASS4.5-L/P00	8051194	8051195	8051196
	8	30V	2A		PUR	BK	•	AL-WASS8-L/S370	8046807	8046996	8046997
			2A		PUR	GY	•	AL-WASS8-L/S370GY	8092221	8092222	8092223
			2A		PVC	GY	•	AL-WASS8-L/P01	8051416	8051417	8051418
			2A		PVC	GY		AL-WASS8-L/P00	8051206	8051207	8051208
12	30V	1.5A		PUR	BK	•	AL-WASS12-L/S370	8047007	8047008	8047009	
		1.5A		PUR	GY	•	AL-WASS12-L/S370GY	8092272	8092273	8092274	
		1.5A		PVC	GY	•	AL-WASS12-L/P01	8051428	8051429	8051430	
		1.5A		PVC	GY		AL-WASS12-L/P00	8051219	8051220	8051221	

标准连接器的长度:2米,5米,或10米。中继电缆长度:1米,2米或5米。法兰面板安装的电线长度:0.5米(0.2米)。其他电缆,电线长度可按照客户要求定制。

	顶端				电缆			产品描述	L = 电缆长度*		
	针脚	最大电压	最大电流	LED	材料	颜色	UL		2m / 1m	5m / 2m	10m / 5m
 <p>延长电缆 公头, 弯型, M12 屏蔽</p>	3	250V	4A		PUR	BK	•	AL-WWASS3-L/S370	8046226	8046227	8046228
			4A		PUR	GY	•	AL-WWASS3-L/S370GY	8091548	8091549	8091550
			4A		PVC	GY	•	AL-WWASS3-L/P01	8051383	8051384	8051385
			4A		PVC	GY		AL-WWASS3-L/P00	8051173	8051174	8051175
	4	250V	4A		PUR	BK	•	AL-WWASS4-L/S370	8046236	8046237	8046238
			4A		PUR	GY	•	AL-WWASS4-L/S370GY	8091602	8091603	8091604
			4A		PVC	GY	•	AL-WWASS4-L/P01	8051395	8051396	8051397
			4A		PVC	GY		AL-WWASS4-L/P00	8051185	8051186	8051187
	5	60V	4A		PUR	BK	•	AL-WWASS4.5-L/S370	8045560	8044617	8044618
			4A		PUR	GY	•	AL-WWASS4.5-L/S370GY	8092201	8092202	8092203
			4A		PVC	GY	•	AL-WWASS4.5-L/P01	8051407	8051408	8051409
			4A		PVC	GY		AL-WWASS4.5-L/P00	8051198	8051197	8051199
	8	30V	2A		PUR	BK	•	AL-WWASS8-L/S370	8046998	8046999	8047000
			2A		PUR	GY	•	AL-WWASS8-L/S370GY	8092253	8092254	8092255
			2A		PVC	GY	•	AL-WWASS8-L/P01	8051419	8051420	8051421
			2A		PVC	GY		AL-WWASS8-L/P00	8051209	8051210	8051211
12	30V	1.5A		PUR	BK	•	AL-WWASS12-L/S370	8047010	8047011	8047012	
		1.5A		PUR	GY	•	AL-WWASS12-L/S370GY	8092280	8092281	8092282	
		1.5A		PVC	GY	•	AL-WWASS12-L/P01	8051431	8051432	8051433	
		1.5A		PVC	GY		AL-WWASS12-L/P00	8051222	8051223	8051224	

标准连接器的长度:2米,5米,或10米。中继电缆长度:1米,2米或5米。法兰面板安装的电线长度:0.5米(0.2米)。其他电缆,电线长度可按照客户要求定制。



	顶端				电缆			产品描述	L = 电缆长度*		
	针脚	最大电压	最大电流	LED	材料	颜色	UL		2m / 1m	5m / 2m	10m / 5m
 连接电缆 母头, 直型, M12 公头, 直型, M12 屏蔽	3	250V	4A		PUR	BK	•	AL-WAKS3-L-AL-WASS3/S370	8051886	8046270	8046271
			4A		PUR	GY	•	AL-WAKS3-L-AL-WASS3/S370GY	8091551	8091552	8091553
			4A		PVC	GY	•	AL-WAKS3-L-AL-WASS3/P01	8051790	8051791	8051792
			4A		PVC	GY		AL-WAKS3-L-AL-WASS3/P00	8051582	8051583	8051584
	4	250V	4A		PUR	BK	•	AL-WAKS4-L-AL-WASS4/S370	8048241	8046282	8046283
			4A		PUR	GY	•	AL-WAKS4-L-AL-WASS4/S370GY	8091606	8091607	8091608
			4A		PVC	GY	•	AL-WAKS4-L-AL-WASS4/P01	8051802	8051803	8051804
			4A		PVC	GY		AL-WAKS4-L-AL-WASS4/P00	8051594	8051595	8051596
	5	60V	4A		PUR	BK	•	AL-WAKS4.5-L-AL-WASS4.5/S370	8047973	8046294	8046295
			4A		PUR	GY	•	AL-WAKS4.5-L-AL-WASS4.5/S370GY	8092204	8092205	8092206
			4A		PVC	GY	•	AL-WAKS4.5-L-AL-WASS4.5/P01	8051814	8051815	8051816
			4A		PVC	GY		AL-WAKS4.5-L-AL-WASS4.5/P00	8051606	8051607	8051608
	8	30V	2A		PUR	BK	•	AL-WAKS8-L-AL-WASS8/S370	8051887	8046968	8047013
			2A		PUR	GY	•	AL-WAKS8-L-AL-WASS8/S370GY	8092256	8092257	8092258
			2A		PVC	GY	•	AL-WAKS8-L-AL-WASS8/P01	8051826	8051827	8051828
			2A		PVC	GY		AL-WAKS8-L-AL-WASS8/P00	8051618	8051619	8051620
12	30V	1.5A		PUR	BK	•	AL-WAKS12-L-AL-WASS12/S370	8051888	8047024	8047025	
		1.5A		PUR	GY		AL-WAKS12-L-AL-WASS12/S370GY	8092283	8092284	8092285	
		1.5A		PVC	GY	•	AL-WAKS12-L-AL-WASS12/P01	8051838	8051839	8051840	
		1.5A		PVC	GY		AL-WAKS12-L-AL-WASS12/P00	8051630	8051631	8051632	

标准连接器的长度:2米,5米,或10米。中继电缆长度:1米,2米或5米。法兰面板安装的电线长度:0.5米(0.2米)。其他电缆,电线长度可按照客户要求定制。

	顶端				电缆			产品描述	L = 电缆长度*		
	针脚	最大电压	最大电流	LED	材料	颜色	UL		2m / 1m	5m / 2m	10m / 5m
 <p>连接电缆 母头, 直型, M12 公头, 弯型, M12 屏蔽</p>	3	250V	4A		PUR	BK	•	AL-WAKS3-L-AL-WWASS3/S370	8051889	8046276	8046277
			4A		PUR	GY	•	AL-WAKS3-L-AL-WWASS3/S370GY	8091554	8091555	8091556
			4A		PVC	GY	•	AL-WAKS3-L-AL-WWASS3/P01	8051796	8051797	8051798
			4A		PVC	GY		AL-WAKS3-L-AL-WWASS3/P00	8051588	8051589	8051590
	4	250V	4A		PUR	BK	•	AL-WAKS4-L-AL-WWASS4/S370	8048802	8046288	8046289
			4A		PUR	GY	•	AL-WAKS4-L-AL-WWASS4/S370GY	8091609	8091610	8091611
			4A		PVC	GY	•	AL-WAKS4-L-AL-WWASS4/P01	8051808	8051809	8051810
			4A		PVC	GY		AL-WAKS4-L-AL-WWASS4/P00	8051600	8051601	8051602
	5	60V	4A		PUR	BK	•	AL-WAKS4.5-L-AL-WWASS4.5/S370	8051890	8046300	8046301
			4A		PUR	GY	•	AL-WAKS4.5-L-AL-WWASS4.5/S370GY	8092207	8092208	8092209
			4A		PVC	GY	•	AL-WAKS4.5-L-AL-WWASS4.5/P01	8051820	8051821	8051822
			4A		PVC	GY		AL-WAKS4.5-L-AL-WWASS4.5/P00	8051612	8051613	8051614
8	30V	2A		PUR	BK	•	AL-WAKS8-L-AL-WWASS8/S370	8051891	8047018	8047019	
		2A		PUR	GY	•	AL-WAKS8-L-AL-WWASS8/S370GY	8092259	8092260	8092261	
		2A		PVC	GY	•	AL-WAKS8-L-AL-WWASS8/P01	8051832	8051833	8051834	
		2A		PVC	GY		AL-WAKS8-L-AL-WWASS8/P00	8051624	8051625	8051626	
12	30V	1.5A		PUR	BK	•	AL-WAKS12-L-AL-WWASS12/S370	8051892	8047030	8047031	
		1.5A		PUR	GY	•	AL-WAKS12-L-AL-WWASS12/S370GY	8092286	8092287	8092288	
		1.5A		PVC	GY	•	AL-WAKS12-L-AL-WWASS12/P01	8051844	8051845	8051846	
		1.5A		PVC	GY		AL-WAKS12-L-AL-WWASS12/P00	8051636	8051637	8051638	



标准连接器的长度:2米,5米,或10米。中继电缆长度:1米,2米或5米。法兰面板安装的电线长度:0.5米(0.2米)。其他电缆,电线长度可按照客户要求定制。

	顶端				电缆			产品描述	L = 电缆长度*		
	针脚	最大电压	最大电流	LED	材料	颜色	UL		2m / 1m	5m / 2m	10m / 5m
 <p>连接电缆 母头, 弯型, M12 公头, 直型, M12 屏蔽</p>	3	250V	4A		PUR	BK	•	AL-WWAKS3-L-AL-WASS3/S370	8051904	8046279	8046280
			4A		PUR	GY	•	AL-WWAKS3-L-AL-WASS3/S370GY	8091557	8091558	8091559
			4A		PVC	GY	•	AL-WWAKS3-L-AL-WASS3/P01	8051799	8051800	8051801
			4A		PVC	GY		AL-WWAKS3-L-AL-WASS3/P00	8051591	8051592	8051593
	4	250V	4A		PUR	BK	•	AL-WWAKS4-L-AL-WASS4/S370	8049426	8046291	8046292
			4A		PUR	GY	•	AL-WWAKS4-L-AL-WASS4/S370GY	8091612	8091613	8091614
			4A		PVC	GY	•	AL-WWAKS4-L-AL-WASS4/P01	8051811	8051812	8051813
			4A		PVC	GY		AL-WWAKS4-L-AL-WASS4/P00	8051603	8051604	8051605
	5	60V	4A		PUR	BK	•	AL-WWAKS4.5-L-AL-WASS4.5/S370	8051897	8046303	8046304
			4A		PUR	GY	•	AL-WWAKS4.5-L-AL-WASS4.5/S370GY	8092210	8092211	8092212
			4A		PVC	GY	•	AL-WWAKS4.5-L-AL-WASS4.5/P01	8051823	8051824	8051825
			4A		PVC	GY		AL-WWAKS4.5-L-AL-WASS4.5/P00	8051615	8051616	8051617
	8	30V	2A		PUR	BK	•	AL-WWAKS8-L-AL-WASS8/S370	8051898	8047021	8047022
			2A		PUR	GY	•	AL-WWAKS8-L-AL-WASS8/S370GY	8092262	8092263	8092264
			2A		PVC	GY	•	AL-WWAKS8-L-AL-WASS8/P01	8051835	8051836	8051837
			2A		PVC	GY		AL-WWAKS8-L-AL-WASS8/P00	8051627	8051628	8051629
12	30V	1.5A		PUR	BK	•	AL-WWAKS12-L-AL-WASS12/S370	8051899	8047033	8047034	
		1.5A		PUR	GY	•	AL-WWAKS12-L-AL-WASS12/S370GY	8092289	8092290	8092291	
		1.5A		PVC	GY	•	AL-WWAKS12-L-AL-WASS12/P01	8051847	8051848	8051849	
		1.5A		PVC	GY		AL-WWAKS12-L-AL-WASS12/P00	8051639	8051640	8051641	



标准连接器的长度:2米,5米,或10米。中继电缆长度:1米,2米或5米。法兰面板安装的电线长度:0.5米(0.2米)。其他电缆,电线长度可按照客户要求定制。

	顶端				电缆			产品描述	L = 电缆长度*		
	针脚	最大电压	最大电流	LED	材料	颜色	UL		2m / 1m	5m / 2m	10m / 5m
 <p>连接电缆 母头, 弯型, M12 公头, 弯型, M12 屏蔽</p>	3	250V	4A		PUR	BK	•	AL-WWAKS3-L-AL-WWASS3/S370	8051900	8046273	8046274
			4A		PUR	GY	•	AL-WWAKS3-L-AL-WWASS3/S370GY	8091560	8091561	8091562
			4A		PVC	GY	•	AL-WWAKS3-L-AL-WWASS3/P01	8051793	8051794	8051795
			4A		PVC	GY		AL-WWAKS3-L-AL-WWASS3/P00	8051585	8051586	8051587
	4	250V	4A		PUR	BK	•	AL-WWAKS4-L-AL-WWASS4/S370	8051901	8046285	8046286
			4A		PUR	GY	•	AL-WWAKS4-L-AL-WWASS4/S370GY	8091615	8091616	8091617
			4A		PVC	GY	•	AL-WWAKS4-L-AL-WWASS4/P01	8051805	8051806	8051807
			4A		PVC	GY		AL-WWAKS4-L-AL-WWASS4/P00	8051597	8051598	8051599
	5	60V	4A		PUR	BK	•	AL-WWAKS4.5-L-AL-WWASS4.5/S370	8051902	8046297	8046298
			4A		PUR	GY	•	AL-WWAKS4.5-L-AL-WWASS4.5/S370GY	8092213	8092214	8092215
			4A		PVC	GY	•	AL-WWAKS4.5-L-AL-WWASS4.5/P01	8051817	8051818	8051819
			4A		PVC	GY		AL-WWAKS4.5-L-AL-WWASS4.5/P00	8051609	8051610	8051611
8	30V	2A		PUR	BK	•	AL-WWAKS8-L-AL-WWASS8/S370	8048908	8047015	8047016	
		2A		PUR	GY	•	AL-WWAKS8-L-AL-WWASS8/S370GY	8092265	8092266	8092267	
		2A		PVC	GY	•	AL-WWAKS8-L-AL-WWASS8/P01	8051829	8051830	8051831	
		2A		PVC	GY		AL-WWAKS8-L-AL-WWASS8/P00	8051621	8051622	8051623	
12	30V	1.5A		PUR	BK	•	AL-WWAKS12-L-AL-WWASS12/S370	8051903	8047027	8047028	
		1.5A		PUR	GY	•	AL-WWAKS12-L-AL-WWASS12/S370GY	8092292	8092293	8092294	
		1.5A		PVC	GY	•	AL-WWAKS12-L-AL-WWASS12/P01	8051841	8051842	8051843	
		1.5A		PVC	GY		AL-WWAKS12-L-AL-WWASS12/P00	8051633	8051634	8051635	



标准连接器的长度:2米,5米,或10米。中继电缆长度:1米,2米或5米。法兰面板安装的电线长度:0.5米(0.2米)。其他电缆,电线长度可按照客户要求定制。

	顶端				电缆			产品描述	L = 电缆长度*		
	针脚	最大电压	最大电流	LED	材料	颜色	UL		2m / 1m	5m / 2m	10m / 5m
 延长电缆 母头, 直型, M8	3	60V	4A		PUR	BK	•	AL-SKP3-L/S370	8043748	8043749	8043750
			4A		PUR	BK	•	AL-SKP3-L/S400	8075430	8075431	8075432
			4A		PUR	GY	•	AL-SKP3-L/S370GY	8059110	8059111	8059112
			4A		PUR	OG	•	AL-SKP3-L/S7400	8059113	8059114	8059115
			4A		PVC	BK	•	AL-SKP3-L/P01BK	8081823	8081824	8081825
			4A		PVC	GY	•	AL-SKP3-L/P01	8051226	8051227	8051228
			4A		PVC	GY		AL-SKP3-L/P00	8048639	8048640	8048641
	4	60V	4A		PUR	BK	•	AL-SKP4-L/S370	8043760	8043761	8043762
			4A		PUR	BK	•	AL-SKP4-L/S400	8075445	8075446	8075447
			4A		PUR	GY	•	AL-SKP4-L/S370GY	8067754	8067755	8067756
			4A		PUR	OG	•	AL-SKP4-L/S7400	8066417	8067456	8067457
			4A		PVC	BK	•	AL-SKP4-L/P01BK	8081835	8081836	8081837
			4A		PVC	GY	•	AL-SKP4-L/P01	8051238	8051239	8051240
4A				PVC	GY		AL-SKP4-L/P00	8048645	8048646	8048647	
5	30V	3A		PUR	BK	•	AL-SKP4.5-L/S370	8051859	8051858	8051860	
		3A		PUR	BK	•	AL-SKP4.5-L/S400	8075460	8075461	8075462	
		3A		PVC	GY		AL-SKP4.5-L/P00	8047045	8051850	8051851	
 延长电缆 母头, 直型, M8 针脚分配 4.028	4	60V	4A		PUR	BK		AL-SKP4.028-L/S370	8086573	8086574	8086575



标准连接器的长度:2米,5米,或10米。中继电缆长度:1米,2米或5米。法兰面板安装的电线长度:0.5米(0.2米)。其他电缆,电线长度可按照客户要求定制。

	顶端	顶端			电缆			产品描述	L = 电缆长度*		
		针脚	最大电压	最大电流	LED	材料	颜色		UL	2m / 1m	5m / 2m
 延长电缆 母头, 弯型, M8	3	60V	4A		PUR	BK	•	AL-SWKP3-L/S370	8043751	8043752	8043753
					PUR	BK	•	AL-SWKP3-L/S400	8075436	8075437	8075438
					PUR	GY	•	AL-SWKP3-L/S370GY	8059116	8059117	8059118
					PUR	OG	•	AL-SWKP3-L/S7400	8059119	8059120	8059121
					PVC	BK	•	AL-SWKP3-L/P01BK	8081826	8081827	8081828
					PVC	GY	•	AL-SWKP3-L/P01	8051229	8051230	8051231
					PVC	GY		AL-SWKP3-L/P00	8048642	8048643	8048644
	4	60V	4A		PUR	BK	•	AL-SWKP4-L/S370	8043763	8043764	8043765
					PUR	BK	•	AL-SWKP4-L/S400	8075451	8075452	8075453
					PUR	GY	•	AL-SWKP4-L/S370GY	8067770	8067774	8067775
					PUR	OG	•	AL-SWKP4-L/S7400	8067467	8067468	8067469
					PVC	BK	•	AL-SWKP4-L/P01BK	8081838	8081839	8081840
					PVC	GY	•	AL-SWKP4-L/P01	8051241	8051242	8051243
					PVC	GY		AL-SWKP4-L/P00	8048648	8048649	8048650
	5	30V	3A		PUR	BK	•	AL-SWKP4.5-L/S370	8051861	8051862	8051863
					PUR	BK	•	AL-SWKP4.5-L/S400	8075466	8075467	8075468
					PVC	GY		AL-SWKP4.5-L/P00	8047049	8051852	8051853
 延长电缆 母头, 弯型, M8 针脚分配 4.028	4	60V	4A		PUR	BK		AL-SWKP4.028-L/S370	8086576	8086577	8086578
 延长电缆 母头, 弯型, M8, 带LED	3	30V	4A	3P2	PUR	BK	•	AL-SWKP3P2-L/S370	8045344	8045419	8045420
					PUR	BK	•	AL-SWKP3P2-L/S400	8075439	8075440	8075441
					PUR	GY	•	AL-SWKP3P2-L/S370GY	8059122	8059123	8059124
					PUR	OG	•	AL-SWKP3P2-L/S7400	8059125	8059126	8059127
					PVC	BK	•	AL-SWKP3P2-L/P01BK	8081883	8081884	8081885
					PVC	GY	•	AL-SWKP3P2-L/P01	8051322	8051323	8051324
					PVC	GY		AL-SWKP3P2-L/P00	8051113	8051114	8051115
	4	30V	4A	4P2	PUR	BK	•	AL-SWKP4P2-L/S370	8045345	8045421	8045422
					PUR	BK	•	AL-SWKP4P2-L/S400	8075454	8075455	8075456
					PUR	GY	•	AL-SWKP4P2-L/S370GY	8067809	8067810	8067811
					PUR	OG	•	AL-SWKP4P2-L/S7400	8067532	8067533	8067534
					PVC	BK	•	AL-SWKP4P2-L/P01BK	8081886	8081887	8081888
					PVC	GY	•	AL-SWKP4P2-L/P01	8051325	8051326	8051327
					PVC	GY		AL-SWKP4P2-L/P00	8051116	8051117	8051118

标准连接器的长度:2米,5米,或10米。中继电缆长度:1米,2米或5米。法兰面板安装的电线长度:0.5米(0.2米)。其他电缆,电线长度可按照客户要求定制。



	顶端				电缆			产品描述	L = 电缆长度*		
	针脚	最大电压	最大电流	LED	材料	颜色	UL		2m / 1m	5m / 2m	10m / 5m
 延长电缆 公头, 直型, M8	3	60V	4A	PUR	BK	•	AL-SSP3-L/S370	8043754	8043755	8043756	
			4A	PUR	BK	•	AL-SSP3-L/S400	8075433	8075434	8075435	
			4A	PUR	GY	•	AL-SSP3-L/S370GY	8059152	8059153	8059154	
			4A	PUR	OG	•	AL-SSP3-L/S7400	8059155	8059156	8059157	
			4A	PVC	BK	•	AL-SSP3-L/P01BK	8081829	8081830	8081831	
			4A	PVC	GY	•	AL-SSP3-L/P01	8051232	8051233	8051234	
			4A	PVC	GY		AL-SSP3-L/P00	8051031	8051032	8051033	
	4	60V	4A	PUR	BK	•	AL-SSP4-L/S370	8043766	8043767	8043768	
			4A	PUR	BK	•	AL-SSP4-L/S400	8075448	8075449	8075450	
			4A	PUR	GY	•	AL-SSP4-L/S370GY	8067758	8067760	8067762	
			4A	PUR	OG	•	AL-SSP4-L/S7400	8067458	8067460	8067461	
			4A	PVC	BK	•	AL-SSP4-L/P01BK	8081841	8081842	8081843	
			4A	PVC	GY	•	AL-SSP4-L/P01	8051244	8051245	8051246	
			4A	PVC	GY		AL-SSP4-L/P00	8051037	8051038	8051039	
5	30V	3A	PUR	BK	•	AL-SSP4.5-L/S370	8050052	8050053	8050054		
		3A	PUR	BK	•	AL-SSP4.5-L/S400	8075463	8075464	8075465		
		3A	PVC	GY		AL-SSP4.5-L/P00	8047066	8050044	8050045		
 延长电缆 公头, 弯型, M8	3	60V	4A	PUR	BK	•	AL-SWSP3-L/S370	8043757	8043758	8043759	
			4A	PUR	BK	•	AL-SWSP3-L/S400	8075442	8075443	8075444	
			4A	PUR	GY	•	AL-SWSP3-L/S370GY	8059158	8059159	8059160	
			4A	PUR	OG	•	AL-SWSP3-L/S7400	8059161	8059162	8059163	
			4A	PVC	BK	•	AL-SWSP3-L/P01BK	8081832	8081833	8081834	
			4A	PVC	GY	•	AL-SWSP3-L/P01	8051235	8051236	8051237	
			4A	PVC	GY		AL-SWSP3-L/P00	8051034	8051035	8051036	
	4	60V	4A	PUR	BK	•	AL-SWSP4-L/S370	8043769	8043770	8043771	
			4A	PUR	BK	•	AL-SWSP4-L/S400	8075457	8075458	8075459	
			4A	PUR	GY	•	AL-SWSP4-L/S370GY	8067763	8067764	8067768	
			4A	PUR	OG	•	AL-SWSP4-L/S7400	8067462	8067463	8067464	
			4A	PVC	BK	•	AL-SWSP4-L/P01BK	8081844	8081845	8081846	
			4A	PVC	GY	•	AL-SWSP4-L/P01	8051247	8051248	8051249	
			4A	PVC	GY		AL-SWSP4-L/P00	8051040	8051041	8051042	
5	30V	3A	PUR	BK	•	AL-SWSP4.5-L/S370	8050055	8050056	8050057		
		3A	PUR	BK	•	AL-SWSP4.5-L/S400	8075469	8075470	8075471		
		3A	PVC	GY		AL-SWSP4.5-L/P00	8047050	8050046	8050047		

标准连接器的长度:2米,5米,或10米。中继电缆长度:1米,2米或5米。法兰面板安装的电线长度:0.5米(0.2米)。其他电缆,电线长度可按照客户要求定制。







		顶端			电缆				L = 电缆长度*		
		针脚	最大电压	最大电流 LED	材料	颜色	UL	产品描述	2m / 1m	5m / 2m	10m / 5m
 连接电缆 母头, 直型, M8 公头, 直型, M8	3	60V	4A	PUR	BK	•	AL-SKP3-L-AL-SSP3/S370	8044811	8044002	8044003	
			4A	PUR	GY	•	AL-SKP3-L-AL-SSP3/S370GY	8059176	8059177	8059178	
			4A	PUR	OG	•	AL-SKP3-L-AL-SSP3/S7400	8059179	8059180	8059181	
			4A	PVC	BK	•	AL-SKP3-L-AL-SSP3/P01BK	8081927	8081928	8081929	
			4A	PVC	GY	•	AL-SKP3-L-AL-SSP3/P01	8051642	8051643	8051644	
			4A	PVC	GY		AL-SKP3-L-AL-SSP3/P00	8051434	8051435	8051436	
	4	60V	4A	PUR	BK	•	AL-SKP4-L-AL-SSP4/S370	8045944	8044017	8044018	
			4A	PUR	GY	•	AL-SKP4-L-AL-SSP4/S370GY	8067813	8067904	8067909	
			4A	PUR	OG	•	AL-SKP4-L-AL-SSP4/S7400	8067535	8067537	8067549	
			4A	PVC	BK	•	AL-SKP4-L-AL-SSP4/P01BK	8081940	8081941	8081942	
			4A	PVC	GY	•	AL-SKP4-L-AL-SSP4/P01	8051655	8051656	8051657	
			4A	PVC	GY		AL-SKP4-L-AL-SSP4/P00	8051447	8051448	8051449	
5	30V	3A	PUR	BK	•	AL-SKP4.5-L-AL-SSP4.5/S370	8052755	8052756	8052757		
		3A	PVC	GY		AL-SKP4.5-L-AL-SSP4.5/P00	8052860	8042846	8042848		
 连接电缆 母头, 直型, M8 公头, 弯型, M8	3	60V	4A	PUR	BK	•	AL-SKP3-L-AL-SWSP3/S370	8051913	8044011	8044012	
			4A	PUR	GY	•	AL-SKP3-L-AL-SWSP3/S370GY	8059182	8059183	8059184	
			4A	PUR	OG	•	AL-SKP3-L-AL-SWSP3/S7400	8059185	8059186	8059188	
			4A	PVC	BK	•	AL-SKP3-L-AL-SWSP3/P01BK	8081933	8081934	8081936	
			4A	PVC	GY	•	AL-SKP3-L-AL-SWSP3/P01	8051649	8051650	8051651	
			4A	PVC	GY		AL-SKP3-L-AL-SWSP3/P00	8051440	8051441	8051442	
	4	60V	4A	PUR	BK	•	AL-SKP4-L-AL-SWSP4/S370	8046587	8044023	8044024	
			4A	PUR	GY	•	AL-SKP4-L-AL-SWSP4/S370GY	8067914	8067915	8067917	
			4A	PUR	OG	•	AL-SKP4-L-AL-SWSP4/S7400	8067559	8067560	8067633	
			4A	PVC	BK	•	AL-SKP4-L-AL-SWSP4/P01BK	8081946	8081947	8081948	
			4A	PVC	GY	•	AL-SKP4-L-AL-SWSP4/P01	8051661	8051662	8051663	
			4A	PVC	GY		AL-SKP4-L-AL-SWSP4/P00	8051453	8051454	8051455	
5	30V	3A	PUR	BK	•	AL-SKP4.5-L-AL-SWSP4.5/S370	8052764	8052765	8052766		
		3A	PVC	GY		AL-SKP4.5-L-AL-SWSP4.5/P00	8042859	8042860	8042861		

标准连接器的长度:2米,5米,或10米。中继电缆长度:1米,2米或5米。法兰面板安装的电线长度:0.5米(0.2米)。其他电缆,电线长度可按照客户要求定制。





	顶端				电缆			产品描述	L = 电缆长度*		
	针脚	最大电压	最大电流	LED	材料	颜色	UL		2m / 1m	5m / 2m	10m / 5m
 <p>连接电缆 母头, 弯型, M8 公头, 直型, M8</p>	3	60V	4A		PUR	BK	•	AL-SWKP3-L-AL-SSP3/S370	8044842	8044014	8044015
			4A		PUR	GY	•	AL-SWKP3-L-AL-SSP3/S370GY	8059189	8059190	8059191
			4A		PUR	OG	•	AL-SWKP3-L-AL-SSP3/S7400	8059192	8059193	8059194
			4A		PVC	BK	•	AL-SWKP3-L-AL-SSP3/P01BK	8081937	8081938	8081939
			4A		PVC	GY	•	AL-SWKP3-L-AL-SSP3/P01	8051652	8051653	8051654
			4A		PVC	GY		AL-SWKP3-L-AL-SSP3/P00	8051444	8051445	8051446
	4	60V	4A		PUR	BK	•	AL-SWKP4-L-AL-SSP4/S370	8046576	8044026	8044027
			4A		PUR	GY	•	AL-SWKP4-L-AL-SSP4/S370GY	8067918	8067920	8067967
			4A		PUR	OG	•	AL-SWKP4-L-AL-SSP4/S7400	8067634	8067641	8067648
			4A		PVC	BK	•	AL-SWKP4-L-AL-SSP4/P01BK	8081949	8081950	8081951
			4A		PVC	GY	•	AL-SWKP4-L-AL-SSP4/P01	8051664	8051665	8051666
			4A		PVC	GY		AL-SWKP4-L-AL-SSP4/P00	8051456	8051457	8051458
5	30V	3A		PUR	BK	•	AL-SWKP4.5-L-AL-SSP4.5/S370	8052761	8052762	8052763	
		3A		PVC	GY		AL-SWKP4.5-L-AL-SSP4.5/P00	8042855	8050039	8042857	
 <p>连接电缆 母头, 弯型, M8 公头, 弯型, M8</p>	3	60V	4A		PUR	BK	•	AL-SWKP3-L-AL-SWSP3/S370	8046572	8044008	8044009
			4A		PUR	GY	•	AL-SWKP3-L-AL-SWSP3/S370GY	8059195	8059196	8059197
			4A		PUR	OG	•	AL-SWKP3-L-AL-SWSP3/S7400	8059198	8059199	8059200
			4A		PVC	BK	•	AL-SWKP3-L-AL-SWSP3/P01BK	8081930	8081931	8081932
			4A		PVC	GY	•	AL-SWKP3-L-AL-SWSP3/P01	8051646	8051647	8051648
			4A		PVC	GY		AL-SWKP3-L-AL-SWSP3/P00	8051437	8051438	8051439
	4	60V	4A		PUR	BK	•	AL-SWKP4-L-AL-SWSP4/S370	8046573	8044020	8044021
			4A		PUR	GY	•	AL-SWKP4-L-AL-SWSP4/S370GY	8067910	8067912	8067913
			4A		PUR	OG	•	AL-SWKP4-L-AL-SWSP4/S7400	8067554	8067555	8067556
			4A		PVC	BK	•	AL-SWKP4-L-AL-SWSP4/P01BK	8081943	8081944	8081945
			4A		PVC	GY	•	AL-SWKP4-L-AL-SWSP4/P01	8051658	8051659	8051660
			4A		PVC	GY		AL-SWKP4-L-AL-SWSP4/P00	8051450	8051451	8051452
5	30V	3A		PUR	BK	•	AL-SWKP4.5-L-AL-SWSP4.5/S370	8052758	8052759	8052760	
		3A		PVC	GY		AL-SWKP4.5-L-AL-SWSP4.5/P00	8042850	8050038	8042852	



标准连接器的长度:2米,5米,或10米。中继电缆长度:1米,2米或5米。法兰面板安装的电线长度:0.5米(0.2米)。其他电缆,电线长度可按照客户要求定制。

		顶端				电缆			产品描述	L = 电缆长度*				
		针脚	最大电压	最大电流	LED	材料	颜色	UL		2m / 1m	5m / 2m	10m / 5m		
 <p>连接电缆 母头, 弯型, M8, 带LED 公头, 直型, M8</p>	3	30V	4A	3P2	PUR	BK	•	AL-SWKP3P2-L-AL-SSP3/S370	8047130	8045932	8045933			
			4A	3P2	PUR	GY	•	AL-SWKP3P2-L-AL-SSP3/S370GY	8059201	8059202	8059203			
			4A	3P2	PUR	OG	•	AL-SWKP3P2-L-AL-SSP3/S7400	8059204	8059205	8059206			
			4A	3P2	PVC	BK	•	AL-SWKP3P2-L-AL-SSP3/P01BK	8082071	8082072	8082073			
			4A	3P2	PVC	GY	•	AL-SWKP3P2-L-AL-SSP3/P01	8051739	8051740	8051741			
			4A	3P2	PVC	GY		AL-SWKP3P2-L-AL-SSP3/P00	8051531	8051532	8051533			
			4A	4P2	PUR	BK	•	AL-SWKP4P2-L-AL-SSP4/S370	8049863	8045935	8045936			
 <p>延长电缆 母头, 直型, M8 屏蔽</p>	4	30V	4A	4P2	PUR	GY	•	AL-SWKP4P2-L-AL-SSP4/S370GY	8067968	8067969	8067970			
			4A	4P2	PUR	OG	•	AL-SWKP4P2-L-AL-SSP4/S7400	8067649	8067703	8067704			
			4A	4P2	PVC	BK	•	AL-SWKP4P2-L-AL-SSP4/P01BK	8081988	8081989	8081990			
			4A	4P2	PVC	GY	•	AL-SWKP4P2-L-AL-SSP4/P01	8051742	8051743	8051744			
			4A	4P2	PVC	GY		AL-SWKP4P2-L-AL-SSP4/P00	8051534	8051535	8051536			
			 <p>延长电缆 母头, 直型, M8 屏蔽</p>	3	60V	4A		PUR	BK	•	AL-SKPS3-L/S370	8046192	8046193	8046194
						4A		PUR	GY	•	AL-SKPS3-L/S370GY	8091071	8091072	8091074
4A		PVC				GY	•	AL-SKPS3-L/P01	8051349	8051350	8051351			
4A		PVC				GY		AL-SKPS3-L/P00	8051140	8051141	8051142			
 <p>延长电缆 母头, 直型, M8 屏蔽</p>	4	60V	4A		PUR	BK	•	AL-SKPS4-L/S370	8046204	8046205	8046206			
			4A		PUR	GY	•	AL-SKPS4-L/S370GY	8091563	8091564	8091565			
			4A		PVC	GY	•	AL-SKPS4-L/P01	8051362	8051363	8051364			
			4A		PVC	GY		AL-SKPS4-L/P00	8051152	8051153	8051154			
 <p>延长电缆 母头, 直型, M8 屏蔽</p>	5	30V	3A		PUR	BK	•	AL-SKPS4.5-L/S370	8047058	8051864	8051865			
			3A		PUR	GY	•	AL-SKPS4.5-L/S370GY	8091618	8091619	8091620			
			3A		PVC	GY		AL-SKPS4.5-L/P00	8047046	8051854	8051855			
 <p>延长电缆 母头, 弯型, M8 屏蔽</p>	3	60V	4A		PUR	BK	•	AL-SWKPS3-L/S370	8046195	8046196	8046197			
			4A		PUR	GY	•	AL-SWKPS3-L/S370GY	8091328	8091329	8091330			
			4A		PVC	GY	•	AL-SWKPS3-L/P01	8051353	8051354	8051355			
			4A		PVC	GY		AL-SWKPS3-L/P00	8051143	8051144	8051145			
	4	60V	4A		PUR	BK	•	AL-SWKPS4-L/S370	8046207	8046208	8046209			
			4A		PUR	GY	•	AL-SWKPS4-L/S370GY	8091569	8091570	8091571			
			4A		PVC	GY	•	AL-SWKPS4-L/P01	8051365	8051366	8051367			
			4A		PVC	GY		AL-SWKPS4-L/P00	8051155	8051156	8051157			
	5	30V	3A		PUR	BK	•	AL-SWKPS4.5-L/S370	8047060	8051866	8051867			
			3A		PUR	GY	•	AL-SWKPS4.5-L/S370GY	8091625	8091626	8091627			
			3A		PVC	GY		AL-SWKPS4.5-L/P00	8047051	8051856	8051857			





标准连接器的长度:2米,5米,或10米。中继电缆长度:1米,2米或5米。法兰面板安装的电线长度:0.5米(0.2米)。其他电缆,电线长度可按照客户要求定制。

	顶端				电缆			产品描述	L = 电缆长度*		
	针脚	最大电压	最大电流	LED	材料	颜色	UL		2m / 1m	5m / 2m	10m / 5m
 延长电缆 公头, 直型, M8 屏蔽	3	60V	4A	PUR	BK	•	AL-SSPS3-L/S370	8046198	8046199	8046200	
			4A	PUR	GY	•	AL-SSPS3-L/S370GY	8091075	8091325	8091326	
			4A	PVC	GY	•	AL-SSPS3-L/P01	8051356	8051357	8051358	
			4A	PVC	GY		AL-SSPS3-L/P00	8051146	8051147	8051148	
	4	60V	4A	PUR	BK	•	AL-SSPS4-L/S370	8046210	8046211	8046212	
			4A	PUR	GY	•	AL-SSPS4-L/S370GY	8091566	8091567	8091568	
			4A	PVC	GY	•	AL-SSPS4-L/P01	8051368	8051369	8051370	
			4A	PVC	GY		AL-SSPS4-L/P00	8051158	8051159	8051160	
	5	30V	3A	PUR	BK	•	AL-SSPS4.5-L/S370	8047061	8050058	8050059	
			3A	PUR	GY	•	AL-SSPS4.5-L/S370GY	8091622	8091623	8091624	
			3A	PVC	GY		AL-SSPS4.5-L/P00	8047048	8050048	8050049	
	 延长电缆 公头, 弯型, M8 屏蔽	3	60V	4A	PUR	BK	•	AL-SWSPS3-L/S370	8046201	8046202	8046203
4A				PUR	GY	•	AL-SWSPS3-L/S370GY	8091331	8091332	8091333	
4A				PVC	GY	•	AL-SWSPS3-L/P01	8051359	8051360	8051361	
4A				PVC	GY		AL-SWSPS3-L/P00	8051149	8051150	8051151	
4		60V	4A	PUR	BK	•	AL-SWSPS4-L/S370	8046214	8046215	8046216	
			4A	PUR	GY	•	AL-SWSPS4-L/S370GY	8091572	8091573	8091574	
			4A	PVC	GY	•	AL-SWSPS4-L/P01	8051371	8051372	8051373	
			4A	PVC	GY		AL-SWSPS4-L/P00	8051161	8051162	8051163	
5		30V	3A	PUR	BK	•	AL-SWSPS4.5-L/S370	8047062	8050060	8050061	
			3A	PUR	GY	•	AL-SWSPS4.5-L/S370GY	8091628	8091629	8091630	
			3A	PVC	GY		AL-SWSPS4.5-L/P00	8047052	8050050	8050051	
 连接电缆 母头, 直型, M8 公头, 直型, M8 屏蔽		3	60V	4A	PUR	BK	•	AL-SKPS3-L-AL-SSPS3/S370	8051896	8046246	8046247
	4A			PUR	GY	•	AL-SKPS3-L-AL-SSPS3/S370GY	8091334	8091335	8091336	
	4A			PVC	GY	•	AL-SKPS3-L-AL-SSPS3/P01	8051766	8051767	8051768	
	4A			PVC	GY		AL-SKPS3-L-AL-SSPS3/P00	8051558	8051559	8051560	
	4	60V	4A	PUR	BK	•	AL-SKPS4-L-AL-SSPS4/S370	8051914	8046258	8046259	
			4A	PUR	GY	•	AL-SKPS4-L-AL-SSPS4/S370GY	8091575	8091576	8091577	
			4A	PVC	GY	•	AL-SKPS4-L-AL-SSPS4/P01	8051778	8051779	8051780	
			4A	PVC	GY		AL-SKPS4-L-AL-SSPS4/P00	8051570	8051571	8051572	
	5	30V	3A	PUR	BK	•	AL-SKPS4.5-L-AL-SSPS4.5/S370	8052768	8052769	8052770	
			3A	PUR	GY	•	AL-SKPS4.5-L-AL-SSPS4.5/S370GY	8091632	8091633	8091634	
			3A	PVC	GY		AL-SKPS4.5-L-AL-SSPS4.5/P00	8042863	8042864	8042865	



标准连接器的长度:2米,5米,或10米。中继电缆长度:1米,2米或5米。法兰面板安装的电线长度:0.5米(0.2米)。其他电缆,电线长度可按照客户要求定制。

		顶端				电缆			L = 电缆长度*			
		针脚	最大电压	最大电流	LED	材料	颜色	UL	产品描述	2m / 1m	5m / 2m	10m / 5m
 <p>连接电缆 母头, 直型, M8 公头, 弯型, M8 屏蔽</p>	3	60V	4A	PUR	BK	•	AL-SKPS3-L-AL-SWSPS3/S370	8051915	8046252	8046253		
			4A	PUR	GY	•	AL-SKPS3-L-AL-SWSPS3/S370GY	8091337	8091338	8091339		
			4A	PVC	GY	•	AL-SKPS3-L-AL-SWSPS3/P01	8051772	8051773	8051774		
			4A	PVC	GY		AL-SKPS3-L-AL-SWSPS3/P00	8051564	8051565	8051566		
	4	60V	4A	PUR	BK	•	AL-SKPS4-L-AL-SWSPS4/S370	8051916	8046264	8046265		
			4A	PUR	GY	•	AL-SKPS4-L-AL-SWSPS4/S370GY	8091579	8091580	8091581		
			4A	PVC	GY	•	AL-SKPS4-L-AL-SWSPS4/P01	8051784	8051785	8051786		
			4A	PVC	GY		AL-SKPS4-L-AL-SWSPS4/P00	8051576	8051577	8051578		
	5	30V	3A	PUR	BK	•	AL-SKPS4.5-L-AL-SWSPS4.5/S370	8052777	8052778	8052779		
			3A	PUR	GY	•	AL-SKPS4.5-L-AL-SWSPS4.5/S370GY	8091635	8091636	8091637		
			3A	PVC	GY		AL-SKPS4.5-L-AL-SWSPS4.5/P00	8042876	8042877	8042878		
	 <p>连接电缆 母头, 弯型, M8 公头, 直型, M8 屏蔽</p>	3	60V	4A	PUR	BK	•	AL-SWKPS3-L-AL-SSPS3/S370	8051917	8046255	8046256	
4A				PUR	GY	•	AL-SWKPS3-L-AL-SSPS3/S370GY	8091340	8091341	8091342		
4A				PVC	GY	•	AL-SWKPS3-L-AL-SSPS3/P01	8051775	8051776	8051777		
4A				PVC	GY		AL-SWKPS3-L-AL-SSPS3/P00	8051567	8051568	8051569		
4		60V	4A	PUR	BK	•	AL-SWKPS4-L-AL-SSPS4/S370	8051918	8046267	8046268		
			4A	PUR	GY	•	AL-SWKPS4-L-AL-SSPS4/S370GY	8091582	8091583	8091584		
			4A	PVC	GY	•	AL-SWKPS4-L-AL-SSPS4/P01	8051787	8051788	8051789		
			4A	PVC	GY		AL-SWKPS4-L-AL-SSPS4/P00	8051579	8051580	8051581		
5		30V	3A	PUR	BK	•	AL-SWKPS4.5-L-AL-SSPS4.5/S370	8052774	8052775	8052776		
			3A	PUR	GY	•	AL-SWKPS4.5-L-AL-SSPS4.5/S370GY	8091638	8091639	8091640		
			3A	PVC	GY		AL-SWKPS4.5-L-AL-SSPS4.5/P00	8042872	8042873	8042874		
 <p>连接电缆 母头, 弯型, M8 公头, 弯型, M8 屏蔽</p>		3	60V	4A	PUR	BK	•	AL-SWKPS3-L-AL-SWSPS3/S370	8051919	8046249	8046250	
	4A			PUR	GY	•	AL-SWKPS3-L-AL-SWSPS3/S370GY	8091343	8091344	8091345		
	4A			PVC	GY	•	AL-SWKPS3-L-AL-SWSPS3/P01	8051769	8051770	8051771		
	4A			PVC	GY		AL-SWKPS3-L-AL-SWSPS3/P00	8051561	8051562	8051563		
	4	60V	4A	PUR	BK	•	AL-SWKPS4-L-AL-SWSPS4/S370	8051920	8046261	8046262		
			4A	PUR	GY	•	AL-SWKPS4-L-AL-SWSPS4/S370GY	8091585	8091586	8091587		
			4A	PVC	GY	•	AL-SWKPS4-L-AL-SWSPS4/P01	8051781	8051782	8051783		
			4A	PVC	GY		AL-SWKPS4-L-AL-SWSPS4/P00	8051573	8051574	8051575		
	5	30V	3A	PUR	BK	•	AL-SWKPS4.5-L-AL-SWSPS4.5/S370	8052771	8052772	8052773		
			3A	PUR	GY	•	AL-SWKPS4.5-L-AL-SWSPS4.5/S370GY	8091641	8091642	8091643		
			3A	PVC	GY		AL-SWKPS4.5-L-AL-SWSPS4.5/P00	8042868	8042869	8042870		



标准连接器的长度:2米,5米,或10米。中继电缆长度:1米,2米或5米。法兰面板安装的电线长度:0.5米(0.2米)。其他电缆,电线长度可按照客户要求定制。

	顶端				电缆			产品描述	L = 电缆长度*		
	针脚	最大电压	最大电流	LED	材料	颜色	UL		2m / 1m	5m / 2m	10m / 5m
 延长电缆 母头, 直型, Ø8mm快插	3	60V	4A		PUR	BK	•	AL-KP3-L/S370	8051894	8044517	8051895
			4A		PUR	BK	•	AL-KP3-L/S400	8075163	8075164	8075410
			4A		PUR	GY	•	AL-KP3-L/S370GY	8059128	8059129	8059130
			4A		PUR	OG	•	AL-KP3-L/S7400	8059131	8059132	8059133
			4A		PVC	BK	•	AL-KP3-L/P01BK	8082013	8082014	8082015
			4A		PVC	GY	•	AL-KP3-L/P01	8052493	8052494	8052495
			4A		PVC	GY		AL-KP3-L/P00	8052490	8052491	8052492
	4	60V	4A		PUR	BK	•	AL-KP4-L/S370	8043940	8045033	8052669
			4A		PUR	BK	•	AL-KP4-L/S400	8075181	8075182	8075418
			4A		PUR	GY	•	AL-KP4-L/S370GY	8067979	8067981	8067982
			4A		PUR	OG	•	AL-KP4-L/S7400	8067709	8067708	8067710
			4A		PVC	BK	•	AL-KP4-L/P01BK	8082031	8082032	8082033
			4A		PVC	GY	•	AL-KP4-L/P01	8052717	8052718	8052719
			4A		PVC	GY		AL-KP4-L/P00	8052690	8052691	8052692
	5	30V	3A		PUR	BK	•	AL-KP4.5-L/S370	8050016	8050017	8050018
			3A		PUR	BK	•	AL-KP4.5-L/S400	8075201	8075202	8075424
			3A		PVC	GY		AL-KP4.5-L/P00	8043847	8050005	8050006
 延长电缆 母头, 直型, Ø8mm快插 线芯横截面积3x0.14mm <sup>2</sup> +2x0.34mm <sup>2</sup>	5	30V	3A		PUR	BK		AL-KP4.5-L/S570	8069859	8070116	8070117





标准连接器的长度:2米,5米,或10米。中继电缆长度:1米,2米或5米。法兰面板安装的电线长度:0.5米(0.2米)。其他电缆,电线长度可按照客户要求定制。

	顶端				电缆			产品描述	L = 电缆长度*		
	针脚	最大电压	最大电流	LED	材料	颜色	UL		2m / 1m	5m / 2m	10m / 5m
 延长电缆 母头, 直型, Ø8mm快插, 带锁定机制	3	60V	4A	PUR	BK	•	AL-ZKP3-L/S370	8052680	8052681	8052682	
			4A	PUR	BK	•	AL-ZKP3-L/S400	8075175	8075176	8075416	
			4A	PUR	GY	•	AL-ZKP3-L/S370GY	8059140	8059141	8059142	
			4A	PUR	OG	•	AL-ZKP3-L/S7400	8059143	8059144	8059145	
			4A	PVC	BK	•	AL-ZKP3-L/P01BK	8082046	8082047	8082048	
			4A	PVC	GY	•	AL-ZKP3-L/P01	8052733	8052734	8052735	
			4A	PVC	GY		AL-ZKP3-L/P00	8052705	8052706	8052707	
	4	60V	4A	PUR	BK	•	AL-ZKP4-L/S370	8046076	8051911	8051912	
			4A	PUR	BK	•	AL-ZKP4-L/S400	8075193	8075194	8075422	
			4A	PUR	GY	•	AL-ZKP4-L/S370GY	8068026	8068027	8068028	
			4A	PUR	OG	•	AL-ZKP4-L/S7400	8067747	8067749	8067750	
			4A	PVC	BK	•	AL-ZKP4-L/P01BK	8082049	8082050	8082051	
			4A	PVC	GY	•	AL-ZKP4-L/P01	8052736	8052737	8052738	
			4A	PVC	GY		AL-ZKP4-L/P00	8052708	8052709	8052710	
5	30V	3A	PUR	BK	•	AL-ZKP4.5-L/S370	8050025	8050026	8050027		
		3A	PUR	BK	•	AL-ZKP4.5-L/S400	8075217	8075218	8075428		
		3A	PVC	GY		AL-ZKP4.5-L/P00	8049768	8050009	8050010		
 延长电缆 母头, 弯型, Ø8mm快插	3	60V	4A	PUR	BK	•	AL-WKP3-L/S370	8052670	8044518	8052671	
			4A	PUR	BK	•	AL-WKP3-L/S400	8075169	8075170	8075412	
			4A	PUR	GY	•	AL-WKP3-L/S370GY	8059134	8059135	8059136	
			4A	PUR	OG	•	AL-WKP3-L/S7400	8059137	8059138	8059139	
			4A	PVC	BK	•	AL-WKP3-L/P01BK	8082037	8082038	8082039	
			4A	PVC	GY	•	AL-WKP3-L/P01	8052724	8052725	8052726	
			4A	PVC	GY		AL-WKP3-L/P00	8052693	8052694	8052695	
	4	60V	4A	PUR	BK	•	AL-WKP4-L/S370	8052672	8045620	8052673	
			4A	PUR	BK	•	AL-WKP4-L/S400	8075187	8075188	8075420	
			4A	PUR	GY	•	AL-WKP4-L/S370GY	8068015	8068022	8068023	
			4A	PUR	OG	•	AL-WKP4-L/S7400	8067716	8067745	8067746	
			4A	PVC	BK	•	AL-WKP4-L/P01BK	8082034	8082035	8082036	
			4A	PVC	GY	•	AL-WKP4-L/P01	8052720	8052721	8052722	
			4A	PVC	GY		AL-WKP4-L/P00	8052696	8052697	8052698	
5	30V	3A	PUR	BK	•	AL-WKP4.5-L/S370	8050022	8050023	8050024		
		3A	PUR	BK	•	AL-WKP4.5-L/S400	8075207	8075208	8075426		
		3A	PVC	GY		AL-WKP4.5-L/P00	8049767	8050007	8050008		

标准连接器的长度:2米,5米,或10米。中继电缆长度:1米,2米或5米。法兰面板安装的电线长度:0.5米(0.2米)。其他电缆,电线长度可按照客户要求定制。



	顶端				电缆			产品描述	L = 电缆长度*		
	针脚	最大电压	最大电流	LED	材料	颜色	UL		2m / 1m	5m / 2m	10m / 5m
 延长电缆 母头, 弯型, Ø8mm快插, 带锁定机制	3	60V	4A	PUR	BK	•	AL-ZWKP3-L/S370	8052683	8052684	8052685	
			4A	PUR	BK	•	AL-ZWKP3-L/S400	8075178	8075179	8075417	
			4A	PUR	GY	•	AL-ZWKP3-L/S370GY	8059146	8059147	8059148	
			4A	PUR	OG	•	AL-ZWKP3-L/S7400	8059149	8059150	8059151	
			4A	PVC	BK	•	AL-ZWKP3-L/P01BK	8082053	8082054	8082055	
			4A	PVC	GY	•	AL-ZWKP3-L/P01	8052739	8052740	8052741	
			4A	PVC	GY		AL-ZWKP3-L/P00	8052711	8052712	8052713	
	4	60V	4A	PUR	BK	•	AL-ZWKP4-L/S370	8046075	8052686	8052687	
			4A	PUR	BK	•	AL-ZWKP4-L/S400	8075198	8075199	8075423	
			4A	PUR	GY	•	AL-ZWKP4-L/S370GY	8068035	8068036	8068037	
			4A	PUR	OG	•	AL-ZWKP4-L/S7400	8067751	8067752	8067753	
			4A	PVC	BK	•	AL-ZWKP4-L/P01BK	8082056	8082057	8082058	
			4A	PVC	GY	•	AL-ZWKP4-L/P01	8052742	8052743	8052744	
			4A	PVC	GY		AL-ZWKP4-L/P00	8052714	8052715	8052716	
5	30V	3A	PUR	BK	•	AL-ZWKP4.5-L/S370	8050028	8050029	8050030		
		3A	PUR	BK	•	AL-ZWKP4.5-L/S400	8075226	8075227	8075429		
		3A	PVC	GY		AL-ZWKP4.5-L/P00	8049769	8050011	8050012		
 延长电缆 公头, 直型, Ø8mm快插	3	60V	4A	PUR	BK	•	AL-SP3-L/S370	8051905	8051906	8051907	
			4A	PUR	BK	•	AL-SP3-L/S400	8075166	8075167	8075411	
			4A	PUR	GY	•	AL-SP3-L/S370GY	8059164	8059165	8059166	
			4A	PUR	OG	•	AL-SP3-L/S7400	8059167	8059168	8059169	
			4A	PVC	BK	•	AL-SP3-L/P01BK	8082016	8082017	8082018	
			4A	PVC	GY	•	AL-SP3-L/P01	8052499	8052500	8052501	
			4A	PVC	GY		AL-SP3-L/P00	8052496	8052497	8052498	
	4	60V	4A	PUR	BK	•	AL-SP4-L/S370	8052674	8052675	8052676	
			4A	PUR	BK	•	AL-SP4-L/S400	8075184	8075185	8075419	
			4A	PUR	GY	•	AL-SP4-L/S370GY	8067972	8067973	8067978	
			4A	PUR	OG	•	AL-SP4-L/S7400	8067705	8067706	8067707	
			4A	PVC	BK	•	AL-SP4-L/P01BK	8082040	8082041	8082042	
			4A	PVC	GY	•	AL-SP4-L/P01	8052727	8052728	8052729	
			4A	PVC	GY		AL-SP4-L/P00	8052699	8052700	8052701	
5	30V	3A	PUR	BK	•	AL-SP4.5-L/S370	8050013	8050014	8050015		
		3A	PUR	BK	•	AL-SP4.5-L/S400	8075204	8075205	8075425		
		3A	PVC	GY		AL-SP4.5-L/P00	8050000	8050001	8050002		

标准连接器的长度:2米,5米,或10米。中继电缆长度:1米,2米或5米。法兰面板安装的电线长度:0.5米(0.2米)。其他电缆,电线长度可按照客户要求定制。

		顶端				电缆			产品描述	L = 电缆长度*			
		针脚	最大电压	最大电流	LED	材料	颜色	UL		2m / 1m	5m / 2m	10m / 5m	
	延长电缆 公头, 弯型, Ø8mm快插	3	60V	4A	PUR	BK	•	AL-WSP3-L/S370	8051908	8051909	8051910		
				4A	PUR	BK	•	AL-WSP3-L/S400	8075172	8075173	8075414		
				4A	PUR	GY	•	AL-WSP3-L/S370GY	8059170	8059171	8059172		
				4A	PUR	OG	•	AL-WSP3-L/S7400	8059173	8059174	8059175		
				4A	PVC	BK	•	AL-WSP3-L/P01BK	8082019	8082020	8082021		
				4A	PVC	GY	•	AL-WSP3-L/P01	8052505	8052506	8052507		
				4A	PVC	GY		AL-WSP3-L/P00	8052502	8052503	8052504		
		4	60V	4A	PUR	BK	•	AL-WSP4-L/S370	8052677	8052678	8052679		
				4A	PUR	BK	•	AL-WSP4-L/S400	8075190	8075191	8075421		
				4A	PUR	GY	•	AL-WSP4-L/S370GY	8068011	8068012	8068014		
				4A	PUR	OG	•	AL-WSP4-L/S7400	8067711	8067712	8067713		
				4A	PVC	BK	•	AL-WSP4-L/P01BK	8082043	8082044	8082045		
				4A	PVC	GY	•	AL-WSP4-L/P01	8052730	8052731	8052732		
				4A	PVC	GY		AL-WSP4-L/P00	8052702	8052703	8052704		
5	30V	3A	PUR	BK	•	AL-WSP4.5-L/S370	8050019	8050020	8050021				
		3A	PUR	BK	•	AL-WSP4.5-L/S400	8075212	8075213	8075427				
		3A	PVC	GY		AL-WSP4.5-L/P00	8043900	8050003	8050004				
	连接电缆 母头, 直型, Ø8mm快插 公头, 直型, Ø8mm快插	3	60V	4A	PUR	BK	•	AL-KP3-L-AL-SP3/S370	8073042	8073043	8071534		
				4A	PUR	GY	•	AL-KP3-L-AL-SP3/S370GY	8075777	8075778	8075779		
				4A	PUR	OG	•	AL-KP3-L-AL-SP3/S7400	8070025	8075725	8062204		
				4A	PVC	GY		AL-KP3-L-AL-SP3/P00	8061414	8057497	8075724		
		4	60V	4A	PUR	BK	•	AL-KP4-L-AL-SP4/S370	8059299	8053638	8044452		
				4A	PUR	GY	•	AL-KP4-L-AL-SP4/S370GY	8075793	8075794	8075795		
				4A	PUR	OG	•	AL-KP4-L-AL-SP4/S7400	8075790	8075791	8075792		
				4A	PVC	GY		AL-KP4-L-AL-SP4/P00	8075728	8075729	8068882		
		5	30V	3A	PUR	BK	•	AL-KP4.5-L-AL-SP4.5/S370	8052970	8052971	8052972		
				3A	PVC	GY		AL-KP4.5-L-AL-SP4.5/P00	8052958	8052959	8052960		
			连接电缆 母头, 直型, Ø8mm快插 公头, 直型, Ø8mm快插 线芯横截面积3x0.14mm <sup>2</sup> +2x0.34mm <sup>2</sup>	5	30V	3A	PUR	BK		AL-KP4.5-L-AL-SP4.5/S570/S320	8088631	8088244	8088894
						4	60V	4A	PUR	BK		AL-KP4.028-L-AL-SP3/S370	8087314

标准连接器的长度:2米,5米,或10米。中继电缆长度:1米,2米或5米。法兰面板安装的电线长度:0.5米(0.2米)。其他电缆,电线长度可按照客户要求定制。



	顶端				电缆			产品描述	L = 电缆长度*		
	针脚	最大电压	最大电流	LED	材料	颜色	UL		2m / 1m	5m / 2m	10m / 5m
 连接电缆 母头, 弯型, Ø8mm快插 公头, 直型, Ø8mm快插	3	60V	4A		PUR	BK	•	AL-WKP3-L-AL-SP3/S370	8063830	8056384	8075727
			4A		PUR	GY	•	AL-WKP3-L-AL-SP3/S370GY	8075787	8075788	8075789
			4A		PUR	OG	•	AL-WKP3-L-AL-SP3/S7400	8075784	8075785	8075786
			4A		PVC	GY		AL-WKP3-L-AL-SP3/P00	8075781	8075782	8075783
	4	60V	4A		PUR	BK	•	AL-WKP4-L-AL-SP4/S370	8076453	8076454	8076455
			4A		PUR	GY	•	AL-WKP4-L-AL-SP4/S370GY	8075802	8075803	8075804
			4A		PUR	OG	•	AL-WKP4-L-AL-SP4/S7400	8075799	8075800	8075801
			4A		PVC	GY		AL-WKP4-L-AL-SP4/P00	8075796	8075797	8075798
5	30V	3A		PUR	BK	•	AL-WKP4.5-L-AL-SP4.5/S370	8052979	8052980	8052981	
		3A		PVC	GY		AL-WKP4.5-L-AL-SP4.5/P00	8052967	8052968	8052969	
 连接电缆 母头, 直型, Ø8mm快插 公头, 直型, M12 线芯横截面积3x0.14mm <sup>2</sup> +2x0.34mm <sup>2</sup>	5	30V	3A		PUR	BK		AL-KP4.5-L-AL-WAS4.5/S570/S320	8070120	8070121	8088895

标准连接器的长度:2米,5米,或10米。中继电缆长度:1米,2米或5米。法兰面板安装的电线长度:0.5米(0.2米)。其他电缆,电线长度可按照客户要求定制。

	针脚	编码	最大电压	最大电流	UL	L [m]	Δh[mm]	插座外壳材料	锁紧螺纹	产品描述	物料编号
 <p>传感器执行器 母头, 直型, M12 前面板安装 (不带固定螺丝) 线芯连接</p>	3	A	250V	4 A	•	0.50		合金, 铜锌, 镀镍	M12x1	AL-FVM12KUA3-0,5/M12	8071727
									M16x1.5	AL-FVM12KUA3-0,5/M16	8071679
									PG9	AL-FVM12KUA3-0,5/PG9	8072461
								不锈钢 1.4404	M16x1.5	AL-FVM12EKUA3-0,5/M16	8082880
									PG9	AL-FVM12EKUA3-0,5/PG9	8082892
	4	A	250V	4 A	•	0.50		合金, 铜锌, 镀镍	M12x1	AL-FVM12KUA4-0,5/M12	8071730
									M16x1.5	AL-FVM12KUA4-0,5/M16	8071682
									PG9	AL-FVM12KUA4-0,5/PG9	8072462
								不锈钢 1.4404	M16x1.5	AL-FVM12EKUA4-0,5/M16	8082881
									PG9	AL-FVM12EKUA4-0,5/PG9	8082893
4+PE	A	60V	4 A	•	0.50		合金, 铜锌, 镀镍	M12x1	AL-FVM12KUA5-0,5/M12	8071738	
								M16x1.5	AL-FVM12KUA5-0,5/M16	8071693	
								PG9	AL-FVM12KUA5-0,5/PG9	8072467	
							不锈钢 1.4404	M16x1.5	AL-FVM12EKUA5-0,5/M16	8082887	
								PG9	AL-FVM12EKUA5-0,5/PG9	8082899	
5	A	60V	4 A	•	0.50		合金, 铜锌, 镀镍	M12x1	AL-FVM12KUA4.5-0,5/M12	8071734	
								M16x1.5	AL-FVM12KUA4.5-0,5/M16	8071691	
								PG9	AL-FVM12KUA4.5-0,5/PG9	8072465	
							不锈钢 1.4404	M16x1.5	AL-FVM12EKUA4.5-0,5/M16	8082885	
								PG9	AL-FVM12EKUA4.5-0,5/PG9	8082897	
8	A	30V	2 A	•	0.50		合金, 铜锌, 镀镍	M12x1	AL-FVM12KUA8-0,5/M12	8071740	
								M16x1.5	AL-FVM12KUA8-0,5/M16	8071695	
								PG9	AL-FVM12KUA8-0,5/PG9	8072469	
							不锈钢 1.4404	M16x1.5	AL-FVM12EKUA8-0,5/M16	8082890	
								PG9	AL-FVM12EKUA8-0,5/PG9	8082906	
12	A	30V	1.5 A	•	0.50		合金, 铜锌, 镀镍	M12x1	AL-FVM12KUA12-0,5/M12	8071742	
								M16x1.5	AL-FVM12KUA12-0,5/M16	8071696	
								PG9	AL-FVM12KUA12-0,5/PG9	8072470	
							不锈钢 1.4404	M16x1.5	AL-FVM12EKUA12-0,5/M16	8082891	
								PG9	AL-FVM12EKUA12-0,5/PG9	8082907	



传感器执行器  
母头,直型, M12  
前面板安装,可定位的  
线芯连接

针脚	编码	最大电压	最大电流	UL	L [m]	Δh[mm]	插座外壳材料	锁紧螺纹	产品描述	物料编号
3	A	250V	4 A	•	0.50		合金, 铜锌, 镀镍	M16x1.5	AL-FVM12KUA3-0,5/M16/S520	8077913
								PG9	AL-FVM12KUA3-0,5/PG9/S520	8077917
							不锈钢 1.4404	M16x1.5	AL-FVM12EKUA3-0,5/M16/S520	8082908
4	A	250V	4 A	•	0.50		合金, 铜锌, 镀镍	M16x1.5	AL-FVM12KUA4-0,5/M16/S520	8077902
								PG9	AL-FVM12KUA4-0,5/PG9/S520	8077918
							不锈钢 1.4404	M16x1.5	AL-FVM12EKUA4-0,5/M16/S520	8082909
4+PE	A	60V	4 A	•	0.50		合金, 铜锌, 镀镍	M16x1.5	AL-FVM12KUA5-0,5/M16/S520	8077908
								PG9	AL-FVM12KUA5-0,5/PG9/S520	8077924
							不锈钢 1.4404	M16x1.5	AL-FVM12EKUA5-0,5/M16/S520	8082915
5	A	60V	4 A	•	0.50		合金, 铜锌, 镀镍	M16x1.5	AL-FVM12KUA4.5-0,5/M16/S520	8077906
								PG9	AL-FVM12KUA4.5-0,5/PG9/S520	8077922
							不锈钢 1.4404	M16x1.5	AL-FVM12EKUA4.5-0,5/M16/S520	8082913
8	A	30V	2 A	•	0.50		合金, 铜锌, 镀镍	M16x1.5	AL-FVM12KUA8-0,5/M16/S520	8077911
								PG9	AL-FVM12KUA8-0,5/PG9/S520	8077927
							不锈钢 1.4404	M16x1.5	AL-FVM12EKUA8-0,5/M16/S520	8082918
12	A	30V	1.5 A	•	0.50		合金, 铜锌, 镀镍	M16x1.5	AL-FVM12KUA12-0,5/M16/S520	8077912
								PG9	AL-FVM12KUA12-0,5/PG9/S520	8077928
							不锈钢 1.4404	M16x1.5	AL-FVM12EKUA12-0,5/M16/S520	8082919

	针脚	编码	最大电压	最大电流	UL	L [m]	Δh[mm]	插座外壳材料	锁紧螺纹	产品描述	物料编号
 传感器执行器 公头, 直型, M12 前面板安装 ( 不带固定螺丝 ) 线芯连接	3	A	250V	4 A	•	0.50		合金, 铜锌, 镀镍	M12x1	AL-FVM12SUA3-0,5/M12	8071831
									M16x1.5	AL-FVM12SUA3-0,5/M16	8071801
									PG9	AL-FVM12SUA3-0,5/PG9	8072486
								不锈钢 1.4404	M16x1.5	AL-FVM12ESUA3-0,5/M16	8082990
									PG9	AL-FVM12ESUA3-0,5/PG9	8083002
	4	A	250V	4 A	•	0.50		合金, 铜锌, 镀镍	M12x1	AL-FVM12SUA4-0,5/M12	8071832
									M16x1.5	AL-FVM12SUA4-0,5/M16	8071802
									PG9	AL-FVM12SUA4-0,5/PG9	8072487
								不锈钢 1.4404	M16x1.5	AL-FVM12ESUA4-0,5/M16	8082991
									PG9	AL-FVM12ESUA4-0,5/PG9	8083019
4+PE	A	60V	4 A	•	0.50		合金, 铜锌, 镀镍	M12x1	AL-FVM12SUA5-0,5/M12	8071837	
								M16x1.5	AL-FVM12SUA5-0,5/M16	8071808	
								PG9	AL-FVM12SUA5-0,5/PG9	8072492	
							不锈钢 1.4404	M16x1.5	AL-FVM12ESUA5-0,5/M16	8082998	
								PG9	AL-FVM12ESUA5-0,5/PG9	8083026	
5	A	60V	4 A	•	0.50		合金, 铜锌, 镀镍	M12x1	AL-FVM12SUA4.5-0,5/M12	8071835	
								M16x1.5	AL-FVM12SUA4.5-0,5/M16	8071805	
								PG9	AL-FVM12SUA4.5-0,5/PG9	8072490	
							不锈钢 1.4404	M16x1.5	AL-FVM12ESUA4.5-0,5/M16	8082995	
								PG9	AL-FVM12ESUA4.5-0,5/PG9	8083023	
8	A	30V	2 A	•	0.50		合金, 铜锌, 镀镍	M12x1	AL-FVM12SUA8-0,5/M12	8071839	
								M16x1.5	AL-FVM12SUA8-0,5/M16	8071810	
								PG9	AL-FVM12SUA8-0,5/PG9	8072494	
							不锈钢 1.4404	M16x1.5	AL-FVM12ESUA8-0,5/M16	8083000	
								PG9	AL-FVM12ESUA8-0,5/PG9	8083028	
12	A	30V	1.5 A	•	0.50		合金, 铜锌, 镀镍	M12x1	AL-FVM12SUA12-0,5/M12	8071840	
								M16x1.5	AL-FVM12SUA12-0,5/M16	8071811	
								PG9	AL-FVM12SUA12-0,5/PG9	8072495	
							不锈钢 1.4404	M16x1.5	AL-FVM12ESUA12-0,5/M16	8083001	
								PG9	AL-FVM12ESUA12-0,5/PG9	8083029	



传感器执行器  
公头, 直型, M12  
前面板安装, 可定位的  
线芯连接

针脚	编码	最大电压	最大电流	UL	L [m]	Δh[mm]	插座外壳材料	锁紧螺纹	产品描述	物料编号
3	A	250V	4 A	•	0.50		合金, 铜锌, 镀镍	M16x1.5	AL-FVM12SUA3-0,5/M16/S520	8077964
								PG9	AL-FVM12SUA3-0,5/PG9/S520	8078052
							不锈钢 1.4404	M16x1.5	AL-FVM12ESUA3-0,5/M16/S520	8083030
							合金, 铜锌, 镀镍	M16x1.5	AL-FVM12SUA4-0,5/M16/S520	8077965
								PG9	AL-FVM12SUA4-0,5/PG9/S520	8078053
							不锈钢 1.4404	M16x1.5	AL-FVM12ESUA4-0,5/M16/S520	8083031
4+PE	A	60V	4 A	•	0.50		合金, 铜锌, 镀镍	M16x1.5	AL-FVM12SUA5-0,5/M16/S520	8077972
								PG9	AL-FVM12SUA5-0,5/PG9/S520	8078060
							不锈钢 1.4404	M16x1.5	AL-FVM12ESUA5-0,5/M16/S520	8083038
							合金, 铜锌, 镀镍	M16x1.5	AL-FVM12SUA4.5-0,5/M16/S520	8077969
								PG9	AL-FVM12SUA4.5-0,5/PG9/S520	8078057
							不锈钢 1.4404	M16x1.5	AL-FVM12ESUA4.5-0,5/M16/S520	8083035
8	A	30V	2 A	•	0.50		合金, 铜锌, 镀镍	M16x1.5	AL-FVM12SUA8-0,5/M16/S520	8077974
								PG9	AL-FVM12SUA8-0,5/PG9/S520	8078062
							不锈钢 1.4404	M16x1.5	AL-FVM12ESUA8-0,5/M16/S520	8083040
							合金, 铜锌, 镀镍	M16x1.5	AL-FVM12SUA12-0,5/M16/S520	8077975
								PG9	AL-FVM12SUA12-0,5/PG9/S520	8078063
							不锈钢 1.4404	M16x1.5	AL-FVM12ESUA12-0,5/M16/S520	8083041

	针脚	编码	最大电压	最大电流	UL	L [m]	Δh[mm]	插座外壳材料	锁紧螺纹	产品描述	物料编号							
 传感器执行器 母头, 直型, M12 后面板安装 (带固定螺丝) 线芯连接	3	A	250V	4 A	•	0.50		合金, 铜锌, 镀镍	PG9	AL-FHM12KUA3-0,5/PG9	8072450							
									M16x1.5	AL-FHM12KUA3-0,5/M16	8071533							
								不锈钢 1.4404	M16x1.5	AL-FHM12EKUA3-0,5/M16	8082719							
								1,0...2,5	合金, 铜锌, 镀镍	M12x1	AL-FHM12KUA3-0,5/M12/S3525	8076756						
								2,5...4,0	合金, 铜锌, 镀镍	M12x1	AL-FHM12KUA3-0,5/M12/S3540	8076742						
								4,0...5,0	合金, 铜锌, 镀镍	M12x1	AL-FHM12KUA3-0,5/M12/S3550	8071705						
	4	A	250V	4 A	•	0.50		合金, 铜锌, 镀镍	M16x1.5	AL-FHM12KUA4-0,5/M16	8071536							
									PG9	AL-FHM12KUA4-0,5/PG9	8072451							
								不锈钢 1.4404	M16x1.5	AL-FHM12EKUA4-0,5/M16	8082720							
								1,0...2,5	合金, 铜锌, 镀镍	M12x1	AL-FHM12KUA4-0,5/M12/S3525	8076795						
								2,5...4,0	合金, 铜锌, 镀镍	M12x1	AL-FHM12KUA4-0,5/M12/S3540	8076794						
								4,0...5,0	合金, 铜锌, 镀镍	M12x1	AL-FHM12KUA4-0,5/M12/S3550	8071707						
								4+PE	A	60V	4 A	•	0.50		合金, 铜锌, 镀镍	M16x1.5	AL-FHM12KUA5-0,5/M16	8071666
																PG9	AL-FHM12KUA5-0,5/PG9	8072456
															不锈钢 1.4404	M16x1.5	AL-FHM12EKUA5-0,5/M16	8082726
															1,0...2,5	合金, 铜锌, 镀镍	M12x1	AL-FHM12KUA5-0,5/M12/S3525
2,5...4,0	合金, 铜锌, 镀镍	M12x1	AL-FHM12KUA5-0,5/M12/S3540	8076807														
4,0...5,0	合金, 铜锌, 镀镍	M12x1	AL-FHM12KUA5-0,5/M12/S3550	8071713														
5	A	60V	4 A	•	0.50		合金, 铜锌, 镀镍	PG9	AL-FHM12KUA4.5-0,5/PG9	8072454								
								M16x1.5	AL-FHM12KUA4.5-0,5/M16	8071540								
							不锈钢 1.4404	M16x1.5	AL-FHM12EKUA4.5-0,5/M16	8082724								
							1,0...2,5	合金, 铜锌, 镀镍	M12x1	AL-FHM12KUA4.5-0,5/M12/S3525	8076801							
							2,5...4,0	合金, 铜锌, 镀镍	M12x1	AL-FHM12KUA4.5-0,5/M12/S3540	8076800							
							4,0...5,0	合金, 铜锌, 镀镍	M12x1	AL-FHM12KUA4.5-0,5/M12/S3550	8071711							
							8	A	30V	2 A	•	0.50		合金, 铜锌, 镀镍	M16x1.5	AL-FHM12KUA8-0,5/M16	8071668	
															PG9	AL-FHM12KUA8-0,5/PG9	8072458	
不锈钢 1.4404	M16x1.5	AL-FHM12EKUA8-0,5/M16	8082729															
1,0...2,5	合金, 铜锌, 镀镍	M12x1	AL-FHM12KUA8-0,5/M12/S3525	8076825														
2,5...4,0	合金, 铜锌, 镀镍	M12x1	AL-FHM12KUA8-0,5/M12/S3540	8076824														
4,0...5,0	合金, 铜锌, 镀镍	M12x1	AL-FHM12KUA8-0,5/M12/S3550	8071716														
12	A	30V	1.5 A	•	0.50		合金, 铜锌, 镀镍	M16x1.5	AL-FHM12KUA12-0,5/M16	8071669								
								PG9	AL-FHM12KUA12-0,5/PG9	8072459								
							不锈钢 1.4404	M16x1.5	AL-FHM12EKUA12-0,5/M16	8082730								
							1,0...2,5	合金, 铜锌, 镀镍	M12x1	AL-FHM12KUA12-0,5/M12/S3525	8076827							
							2,5...4,0	合金, 铜锌, 镀镍	M12x1	AL-FHM12KUA12-0,5/M12/S3540	8076826							
							4,0...5,0	合金, 铜锌, 镀镍	M12x1	AL-FHM12KUA12-0,5/M12/S3550	8071718							



传感器执行器  
母头, 直型, M12  
后面板安装 (带固定螺丝)  
PC板-连接

针脚	编码	最大电压	最大电流 UL	L [m]	Δh[mm]	插座外壳材料	锁紧螺纹	产品描述	物料编号						
3	A	250V	4 A	•		合金, 铜锌, 镀镍	M16x1.5	AL-FHM12KUA3-P/M16	8072160						
							PG9	AL-FHM12KUA3-P/PG9	8072173						
						1,0...2,5	合金, 铜锌, 镀镍	M12x1	AL-FHM12KUA3-P/M12/S3525	8076558					
								2,5...4,0	合金, 铜锌, 镀镍	M12x1	AL-FHM12KUA3-P/M12/S3540	8076557			
						4,0...5,0	合金, 铜锌, 镀镍	M12x1	AL-FHM12KUA3-P/M12/S3550	8072202					
								4,0...5,0	合金, 铜锌, 镀镍	M12x1	AL-FHM12KUA3-P/M12/S3550	8072202			
						4	A			250V	4 A	•	合金, 铜锌, 镀镍	M16x1.5	AL-FHM12KUA4-P/M16
								PG9	AL-FHM12KUA4-P/PG9					8072174	
								1,0...2,5	合金, 铜锌, 镀镍				M12x1	AL-FHM12KUA4-P/M12/S3525	8076560
													2,5...4,0	合金, 铜锌, 镀镍	M12x1
4,0...5,0	合金, 铜锌, 镀镍	M12x1	AL-FHM12KUA4-P/M12/S3550	8072203											
		4,0...5,0	合金, 铜锌, 镀镍	M12x1	AL-FHM12KUA4-P/M12/S3550			8072203							
4+PE	A			60V	4 A			•	合金, 铜锌, 镀镍				M16x1.5	AL-FHM12KUA5-P/M16	8072168
		PG9	AL-FHM12KUA5-P/PG9										8072177		
		1,0...2,5	合金, 铜锌, 镀镍						M12x1				AL-FHM12KUA5-P/M12/S3525	8076566	
									2,5...4,0				合金, 铜锌, 镀镍	M12x1	AL-FHM12KUA5-P/M12/S3540
		4,0...5,0	合金, 铜锌, 镀镍			M12x1	AL-FHM12KUA5-P/M12/S3550		8072206						
						4,0...5,0	合金, 铜锌, 镀镍		M12x1	AL-FHM12KUA5-P/M12/S3550	8072206				
		8	A						30V	2 A	•	合金, 铜锌, 镀镍	M16x1.5	AL-FHM12KUA8-P/M16	8072170
						PG9	AL-FHM12KUA8-P/PG9						8072179		
						1,0...2,5	合金, 铜锌, 镀镍					M12x1	AL-FHM12KUA8-P/M12/S3525	8076570	
												2,5...4,0	合金, 铜锌, 镀镍	M12x1	AL-FHM12KUA8-P/M12/S3540
4,0...5,0	合金, 铜锌, 镀镍			M12x1	AL-FHM12KUA8-P/M12/S3550	8072208									
				4,0...5,0	合金, 铜锌, 镀镍	M12x1	AL-FHM12KUA8-P/M12/S3550	8072208							
12	A					30V	1.5 A	•				合金, 铜锌, 镀镍	M16x1.5	AL-FHM12KUA12-P/M16	8072171
				PG9	AL-FHM12KUA12-P/PG9								8072180		
				1,0...2,5	合金, 铜锌, 镀镍							M12x1	AL-FHM12KUA12-P/M12/S3525	8076572	
												2,5...4,0	合金, 铜锌, 镀镍	M12x1	AL-FHM12KUA12-P/M12/S3540
		4,0...5,0	合金, 铜锌, 镀镍	M12x1	AL-FHM12KUA12-P/M12/S3550				8072209						
				4,0...5,0	合金, 铜锌, 镀镍				M12x1	AL-FHM12KUA12-P/M12/S3550	8072209				



传感器执行器  
母头,直型, M12  
后面板安装 (带固定螺丝)  
PC板-连接  
屏蔽



针脚	编码	最大电压	最大电流	UL	L [m]	Δh[mm]	插座外壳材料	锁紧螺纹	产品描述	物料编号
3	A	250V	4 A	•			合金, 铜锌, 镀镍	M16x1.5	AL-FHM12KSA3-P/M16	8072214
								PG9	AL-FHM12KSA3-P/PG9	8072239
4	A	250V	4 A	•			合金, 铜锌, 镀镍	PG9	AL-FHM12KSA4-P/PG9	8072240
								M16x1.5	AL-FHM12KSA4-P/M16	8072215
4+PE	A	60V	4 A	•			合金, 铜锌, 镀镍	PG9	AL-FHM12KSA5-P/PG9	8072243
								M16x1.5	AL-FHM12KSA5-P/M16	8072218
8	A	30V	2 A	•			合金, 铜锌, 镀镍	M16x1.5	AL-FHM12KSA8-P/M16	8088765
								PG9	AL-FHM12KSA8-P/PG9	8088766
12	A	30V	1.5 A	•			合金, 铜锌, 镀镍	M16x1.5	AL-FHM12KSA12-P/M16	8088767
								PG9	AL-FHM12KSA12-P/PG9	8088768



传感器执行器  
公头,直型, M12  
后面板安装 (带固定螺丝)  
线芯连接

3	A	250V	4 A	•	0.50		合金, 铜锌, 镀镍	M12x1	AL-FHM12SUA3-0,5/M12	8071819
								M16x1.5	AL-FHM12SUA3-0,5/M16	8071790
								PG9	AL-FHM12SUA3-0,5/PG9	8072475
4	A	250V	4 A	•	0.50		不锈钢 1.4404	M16x1.5	AL-FHM12ESUA3-0,5/M16	8082977
							合金, 铜锌, 镀镍	M12x1	AL-FHM12SUA4-0,5/M12	8071820
								M16x1.5	AL-FHM12SUA4-0,5/M16	8071791
4+PE	A	60V	4 A	•	0.50		合金, 铜锌, 镀镍	PG9	AL-FHM12SUA4-0,5/PG9	8072476
								M16x1.5	AL-FHM12SUA4-0,5/M16	8071796
							不锈钢 1.4404	M16x1.5	AL-FHM12ESUA4-0,5/M16	8082978
5	A	60V	4 A	•	0.50		合金, 铜锌, 镀镍	M12x1	AL-FHM12SUA5-0,5/M12	8071825
								M16x1.5	AL-FHM12SUA5-0,5/M16	8071796
							PG9	AL-FHM12SUA5-0,5/PG9	8072481	
8	A	30V	2 A	•	0.50		不锈钢 1.4404	M16x1.5	AL-FHM12ESUA5-0,5/M16	8082985
							合金, 铜锌, 镀镍	M12x1	AL-FHM12SUA4.5-0,5/M12	8071823
								M16x1.5	AL-FHM12SUA4.5-0,5/M16	8071794
12	A	30V	1.5 A	•	0.50		合金, 铜锌, 镀镍	PG9	AL-FHM12SUA4.5-0,5/PG9	8072479
								M16x1.5	AL-FHM12SUA4.5-0,5/M16	8071794
							不锈钢 1.4404	M16x1.5	AL-FHM12ESUA4.5-0,5/M16	8082982
8	A	30V	2 A	•	0.50		合金, 铜锌, 镀镍	M12x1	AL-FHM12SUA8-0,5/M12	8071827
								M16x1.5	AL-FHM12SUA8-0,5/M16	8071799
							PG9	AL-FHM12SUA8-0,5/PG9	8072483	
12	A	30V	1.5 A	•	0.50		不锈钢 1.4404	M16x1.5	AL-FHM12ESUA8-0,5/M16	8082987
							合金, 铜锌, 镀镍	M12x1	AL-FHM12SUA12-0,5/M12	8071829
								M16x1.5	AL-FHM12SUA12-0,5/M16	8071800
								PG9	AL-FHM12SUA12-0,5/PG9	8072484
								不锈钢 1.4404	M16x1.5	AL-FHM12ESUA12-0,5/M16



	针脚	编码	最大电压	最大电流 UL	L [m]	Δh[mm]	插座外壳材料	锁紧螺纹	产品描述	物料编号	
 传感器执行器 公头, 直型, M12 后面板安装 (带固定螺丝) PC板-连接	3	A	250V	4 A	•		合金, 铜锌, 镀镍	M12x1	AL-FHM12SUA3-P/M12	8072370	
								M16x1.5	AL-FHM12SUA3-P/M16	8072348	
								PG9	AL-FHM12SUA3-P/PG9	8072360	
							不锈钢 1.4404	M16x1.5	AL-FHM12ESUA3-P/M16	8084962	
	4	A	250V	4 A	•			合金, 铜锌, 镀镍	M12x1	AL-FHM12SUA4-P/M12	8072371
									M16x1.5	AL-FHM12SUA4-P/M16	8072349
									PG9	AL-FHM12SUA4-P/PG9	8072361
							不锈钢 1.4404	M16x1.5	AL-FHM12ESUA4-P/M16	8084963	
	4+PE	A	60V	4 A	•			合金, 铜锌, 镀镍	M12x1	AL-FHM12SUA5-P/M12	8072376
									M16x1.5	AL-FHM12SUA5-P/M16	8072354
									PG9	AL-FHM12SUA5-P/PG9	8072366
							不锈钢 1.4404	M16x1.5	AL-FHM12ESUA5-P/M16	8084991	
5	A	60V	4 A	•			合金, 铜锌, 镀镍	M12x1	AL-FHM12SUA4.5-P/M12	8072374	
								M16x1.5	AL-FHM12SUA4.5-P/M16	8072352	
								PG9	AL-FHM12SUA4.5-P/PG9	8072364	
						不锈钢 1.4404	M16x1.5	AL-FHM12ESUA4.5-P/M16	8084970		
8	A	30V	2 A	•			合金, 铜锌, 镀镍	M12x1	AL-FHM12SUA8-P/M12	8072378	
								M16x1.5	AL-FHM12SUA8-P/M16	8072356	
								PG9	AL-FHM12SUA8-P/PG9	8072368	
						不锈钢 1.4404	M16x1.5	AL-FHM12ESUA8-P/M16	8084994		
12	A	30V	1.5 A	•			合金, 铜锌, 镀镍	M12x1	AL-FHM12SUA12-P/M12	8072379	
								M16x1.5	AL-FHM12SUA12-P/M16	8072357	
								PG9	AL-FHM12SUA12-P/PG9	8072369	
						不锈钢 1.4404	M16x1.5	AL-FHM12ESUA12-P/M16	8085002		
 传感器执行器 公头, 直型, M12 后面板安装 (带固定螺丝) PC板-连接 屏蔽	3	A	250V	4 A	•		合金, 铜锌, 镀镍	M16x1.5	AL-FHM12SSA3-P/M16	8072380	
									PG9	AL-FHM12SSA3-P/PG9	8072388
	4	A	250V	4 A	•			合金, 铜锌, 镀镍	PG9	AL-FHM12SSA4-P/PG9	8072389
										M16x1.5	AL-FHM12SSA4-P/M16
	4+PE	A	60V	4 A	•			合金, 铜锌, 镀镍	M16x1.5	AL-FHM12SSA5-P/M16	8072386
										PG9	AL-FHM12SSA5-P/PG9
	5	A	60V	4 A	•			合金, 铜锌, 镀镍	M16x1.5	AL-FHM12SSA4.5-P/M16	8072384
										PG9	AL-FHM12SSA4.5-P/PG9
	8	A	30V	2 A	•			合金, 铜锌, 镀镍	M16x1.5	AL-FHM12SSA8-P/M16	8088769
										PG9	AL-FHM12SSA8-P/PG9
	12	A	30V	1.5 A	•			合金, 铜锌, 镀镍	M16x1.5	AL-FHM12SSA12-P/M16	8088771
										PG9	AL-FHM12SSA12-P/PG9

		针脚	编码	最大电压	最大电流	UL	L [m]	Δh[mm]	插座外壳材料	锁紧螺纹	产品描述	物料编号	
	传感器执行器 母头, 直型, M8 前面板安装 (带固定螺丝) 线芯连接	3	A	60V	4 A	•	0.20	2,0...5,0	合金, 铜锌, 镀镍	M8x0,5	AL-FVM8KUA3-0,2/M8	8071345	
								2,0...5,0	不锈钢 1.4404	M8x0,5	AL-FVM8EKUA3-0,2/M8	8084376	
		4	A	60V	4 A	•	0.20	2,0...5,0	合金, 铜锌, 镀镍	M8x0,5	M8x0,5	AL-FVM8KUA4-0,2/M8	8071346
									2,0...5,0	不锈钢 1.4404	M8x0,5	AL-FVM8EKUA4-0,2/M8	8084377
		5	B	30V	3 A	•	0.20	2,0...5,0	合金, 铜锌, 镀镍	M8x0,5	M8x0,5	AL-FVM8KUB4.5-0,2/M8	8071347
									2,0...5,0	不锈钢 1.4404	M8x0,5	AL-FVM8EKUB4.5-0,2/M8	8084378
	传感器执行器 公头, 直型, M8 前面板安装 (带固定螺丝) 线芯连接	3	A	60V	4 A	•	0.20	2,0...5,0	合金, 铜锌, 镀镍	M8x0,5	AL-FVM8SUA3-0,2/M8	8071417	
								2,0...5,0	不锈钢 1.4404	M8x0,5	AL-FVM8ESUA3-0,2/M8	8084382	
		4	A	60V	4 A	•	0.20	2,0...5,0	合金, 铜锌, 镀镍	M8x0,5	M8x0,5	AL-FVM8SUA4-0,2/M8	8071419
									2,0...5,0	不锈钢 1.4404	M8x0,5	AL-FVM8ESUA4-0,2/M8	8084383
		5	B	30V	3 A	•	0.20	2,0...5,0	合金, 铜锌, 镀镍	M8x0,5	M8x0,5	AL-FVM8SUB4.5-0,2/M8	8071420
									2,0...5,0	不锈钢 1.4404	M8x0,5	AL-FVM8ESUB4.5-0,2/M8	8084384
	传感器执行器 母头, 直型, M8 后面板安装 (带固定螺丝) 线芯连接	3	A	60V	4 A	•	0.20	3,0...6,0	合金, 铜锌, 镀镍	M10x1	AL-FHM8KUA3-0,2/M10	8071402	
								3,0...6,0	不锈钢 1.4404	M10x1	AL-FHM8EKUA3-0,2/M10	8084379	
		4	A	60V	4 A	•	0.20	3,0...6,0	合金, 铜锌, 镀镍	M10x1	M10x1	AL-FHM8KUA4-0,2/M10	8071405
									3,0...6,0	不锈钢 1.4404	M10x1	AL-FHM8EKUA4-0,2/M10	8084380
		5	B	30V	3 A	•	0.20	3,0...6,0	合金, 铜锌, 镀镍	M10x1	M10x1	AL-FHM8KUB4.5-0,2/M10	8071406
									3,0...6,0	不锈钢 1.4404	M10x1	AL-FHM8EKUB4.5-0,2/M10	8084381
	传感器执行器 公头, 直型, M8 后面板安装 (带固定螺丝) 线芯连接	3	A	60V	4 A	•	0.20	2,0...4,5	合金, 铜锌, 镀镍	M8x1	AL-FHM8SUA3-0,2/M8	8071421	
								2,0...4,5	不锈钢 1.4404	M8x1	AL-FHM8ESUA3-0,2/M8	8084385	
		4	A	60V	4 A	•	0.20	2,0...4,5	合金, 铜锌, 镀镍	M8x1	M8x1	AL-FHM8SUA4-0,2/M8	8071422
									2,0...4,5	不锈钢 1.4404	M8x1	AL-FHM8ESUA4-0,2/M8	8084386
		5	B	30V	3 A	•	0.20	2,0...4,5	合金, 铜锌, 镀镍	M8x1	M8x1	AL-FHM8SUB4.5-0,2/M8	8071423
									2,0...4,5	不锈钢 1.4404	M8x1	AL-FHM8ESUB4.5-0,2/M8	8084387
	传感器执行器 母头, 直型, M8 后面板安装 (带固定螺丝) PC板-连接	3	A	60V	4 A	•		3,0...6,0	合金, 铜锌, 镀镍	M10x1	AL-FHM8KUA3-P/M10	8073385	
								3,0...6,0	不锈钢 1.4404	M10x1	AL-FHM8EKUA3-P/M10	8084388	
		4	A	60V	4 A	•		3,0...6,0	合金, 铜锌, 镀镍	M10x1	M10x1	AL-FHM8KUA4-P/M10	8073386
									3,0...6,0	不锈钢 1.4404	M10x1	AL-FHM8EKUA4-P/M10	8084389
		5	B	30V	3 A	•		3,0...6,0	合金, 铜锌, 镀镍	M10x1	M10x1	AL-FHM8KUB4.5-P/M10	8073387
									3,0...6,0	不锈钢 1.4404	M10x1	AL-FHM8EKUB4.5-P/M10	8084390
	传感器执行器 公头, 直型, M8 后面板安装 (带固定螺丝) PC板-连接	3	A	60V	4 A	•		2,0...4,5	合金, 铜锌, 镀镍	M8x1	AL-FHM8SUA3-P/M8	8073397	
								2,0...4,5	不锈钢 1.4404	M8x1	AL-FHM8ESUA3-P/M8	8084391	
		4	A	60V	4 A	•		2,0...4,5	合金, 铜锌, 镀镍	M8x1	M8x1	AL-FHM8SUA4-P/M8	8073398
									2,0...4,5	不锈钢 1.4404	M8x1	AL-FHM8ESUA4-P/M8	8084392
		5	B	30V	3 A	•		2,0...4,5	合金, 铜锌, 镀镍	M8x1	M8x1	AL-FHM8SUB4.5-P/M8	8073399
									2,0...4,5	不锈钢 1.4404	M8x1	AL-FHM8ESUB4.5-P/M8	8084393

		针脚	编码	最大电压	最大电流 UL	L [m]	Δh[mm]	插座外壳材料	锁紧螺纹	产品描述	物料编号
	传感器执行器 母头, 直型, M8 后面板安装 (带固定螺丝) PC板-连接 屏蔽	3	A	60V	4 A	•		合金, 铜锌, 镀镍	M10x1	AL-FHM8KSA3-P/M10	8073389
		4	A	60V	4 A	•		合金, 铜锌, 镀镍	M10x1	AL-FHM8KSA4-P/M10	8073390
		5	B	30V	3 A	•		合金, 铜锌, 镀镍	M10x1	AL-FHM8KSB4.5-P/M10	8073391
	传感器执行器 公头, 直型, M8 后面板安装 (带固定螺丝) PC板-连接 屏蔽	3	A	60V	4 A	•		合金, 铜锌, 镀镍	M8x1	AL-FHM8SSA3-P/M8	8073400
		4	A	60V	4 A	•		合金, 铜锌, 镀镍	M8x1	AL-FHM8SSA4-P/M8	8073401
		5	B	30V	3 A	•		合金, 铜锌, 镀镍	M8x1	AL-FHM8SSB4.5-P/M8	8073402
	传感器执行器 母头, 弯型, M8 后面板安装 (带固定螺丝) PC板-连接 屏蔽	3	A	60V	4 A	•		合金, 铜锌, 镀镍	M10x1	AL-WFHM8KSA3-P/M10	8088510
		4	A	60V	4 A	•		合金, 铜锌, 镀镍	M10x1	AL-WFHM8KSA4-P/M10	8088511
		5	B	30V	3 A	•		合金, 铜锌, 镀镍	M10x1	AL-WFHM8KSB4.5-P/M10	8088512
	传感器执行器 公头, 弯型, M8 后面板安装 (带固定螺丝) PC板-连接 屏蔽	3	A	60V	4 A	•		合金, 铜锌, 镀镍	M8x1	AL-WFHM8SSA3-P/M8	8088515
		4	A	60V	4 A	•		合金, 铜锌, 镀镍	M8x1	AL-WFHM8SSA4-P/M8	8088516
		5	B	30V	3 A	•		合金, 铜锌, 镀镍	M8x1	AL-WFHM8SSB4.5-P/M8	8088517

对接连接器命名

连接电缆

FB-	S	W	WAK	H	3-	P2-	L	- FB-	S	W	WAS	H	3	/S3930
														电缆材质
														针脚数
														卫生设计
														WAS: M12 针头 (公头)   SP: M8 针头 (公头)
														W: 弯型   无: 直型
														M8x1 可拧紧
														Food&Beverage 食品&饮料加工行业
														电缆长度 [m]
														PNP   LED + 电路
														针脚数
														卫生设计
														WAK: M12 孔头 (母头)   WAS: M12 针头 (公头)   KP: M8 孔头 (母头)   SP: M8 针头 (公头)
														W: 弯型   无: 直型
														M8 可拧紧
														Food&Beverage 食品&饮料加工行业



电缆	材料	UL	颜色	特性
P00	PVC/PVC		GY	
P01	PVC/PVC	✓	GY	
S3930	TPE/TPE		GY	通过FDA标准的材料, 优秀的抗微生物性和抗化学品性

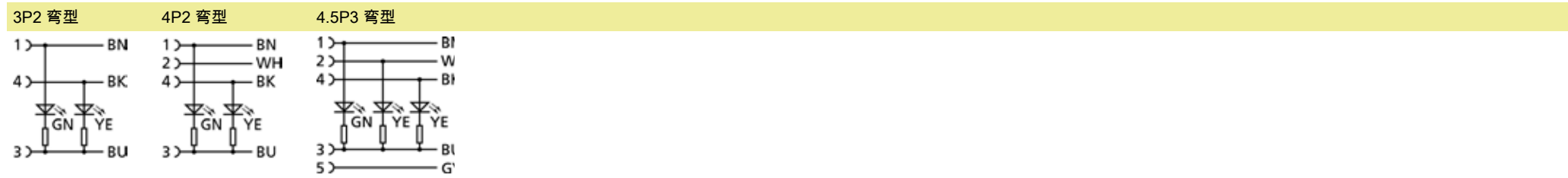







\*见宣传页 "Plastic locking nut for Food &amp; Beverage"







## Food &amp; Beverage









技术参数	M12	M8	法兰连接	现场接线连接器
绝缘电阻	$\geq 10^8 \Omega$	$\geq 10^8 \Omega$	$\geq 10^8 \Omega$	$\geq 10^8 \Omega$
电阻	$\leq 5 m\Omega$	$\leq 5 m\Omega$	$\leq 5 m\Omega$	$\leq 5 m\Omega$
产品环境温度	-40°C...+105°C	-40°C...+105°C	-40°C...+105°C	-40°C...+85°C
触点材料	合金, 镀金	合金, 镀金	合金, 镀金	合金, 镀金
触头载体材料	塑料, PP	塑料, PP	塑料, PP	塑料, PA
夹紧基体材料	塑料, PP	塑料, PP		锌压铸, 镀镍
连接螺母材料	不锈钢, V4A	不锈钢, V4A	不锈钢, V4A	不锈钢, V4A
密封(母头)材料	EPDM	EPDM	FPM/FKM	
防护密封件材料			EPDM	
插座外壳材料			V4A	
标准	IEC 61076-2-101	IEC 61076-2-104	IEC 61076-2-101	IEC 61076-2-101
防护等级 (安装好)	IP65, IP67, IP68, IP69	IP65, IP67, IP68, IP69	IP65, IP67, IP68, IP69	IP67
机械寿命周期	>100 插拔次数	>100 插拔次数	>100 插拔次数	>100 插拔次数
污染等级	3	3/2	3	3
电缆出口				4...6 mm
连接横截面积				max. 0,75 mm <sup>2</sup>

我们食品&包装连接器的卫生设计是更具EHEDG指令。符合FDA要求的材料保证高耐酸碱清洗和消毒物质。所有M8和M12的元器件是防尘和防水的, 同样也免疫于高压蒸汽喷射清洗的水 (IP65, IP67, IP68和IP69)。有PVC和TPE可选, 我们为您的应用提供正确的电缆质量。





我们的新经济型不锈钢替代品: 耐高温、耐介质M12塑料锁紧螺母。

		顶端			电缆			L = 电缆长度*			
		针脚	最大电压	最大电流 LED	材料	颜色	UL	产品描述	2m / 1m	5m / 2m	10m / 5m
	延长电缆 母头, 直型, M12	3	250V	4A	PVC	GY	FB-WAKH3-L/P00	8063805	8063806	8063807	
				4A	PVC	GY	FB-WAKH3-L/P01	8063748	8063749	8063752	
				4A	TPE	GY	FB-WAKH3-L/S3930	8050462	8058555	8058556	
		4	250V	4A	PVC	GY	FB-WAKH4-L/P00	8063811	8063812	8063813	
				4A	PVC	GY	FB-WAKH4-L/P01	8063724	8063725	8063728	
				4A	TPE	GY	FB-WAKH4-L/S3930	8050464	8058557	8058558	
		5	60V	4A	PVC	GY	FB-WAKH4.5-L/P00	8063817	8063818	8063819	
				4A	PVC	GY	FB-WAKH4.5-L/P01	8063739	8063740	8063741	
				4A	TPE	GY	FB-WAKH4.5-L/S3930	8063882	8063883	8063884	
	延长电缆 母头, 弯型, M12	3	250V	4A	PVC	GY	FB-WWAKH3-L/P00	8063834	8063835	8063836	
				4A	PVC	GY	FB-WWAKH3-L/P01	8063703	8063704	8063705	
				4A	TPE	GY	FB-WWAKH3-L/S3930	8050463	8058559	8058560	
		4	250V	4A	PVC	GY	FB-WWAKH4-L/P00	8063799	8063800	8063801	
				4A	PVC	GY	FB-WWAKH4-L/P01	8063672	8063673	8063674	
				4A	TPE	GY	FB-WWAKH4-L/S3930	8050465	8058561	8058562	
		5	60V	4A	PVC	GY	FB-WWAKH4.5-L/P00	8063823	8063824	8063825	
				4A	PVC	GY	FB-WWAKH4.5-L/P01	8063687	8063688	8063689	
				4A	TPE	GY	FB-WWAKH4.5-L/S3930	8063885	8063886	8063887	
	延长电缆 母头, 弯型, M12, 带LED	3	30V	3A	3P2	PVC	GY	FB-WWAKH3P2-L/P00	8063826	8063827	8063828
				3A	3P2	PVC	GY	FB-WWAKH3P2-L/P01	8063692	8063693	8063694
				3A	3P2	TPE	GY	FB-WWAKH3P2-L/S3930	8058611	8058612	8058613
		4	30V	3A	4P2	PVC	GY	FB-WWAKH4P2-L/P00	8063787	8063788	8063789
				3A	4P2	PVC	GY	FB-WWAKH4P2-L/P01	8063666	8063667	8063668
				3A	4P2	TPE	GY	FB-WWAKH4P2-L/S3930	8058614	8058615	8058616
		5	30V	3A	5P3	PVC	GY	FB-WWAKH4.5P3-L/P00	8063808	8063809	8063810
				3A	5P3	PVC	GY	FB-WWAKH4.5P3-L/P01	8063678	8063679	8063680
				3A	5P3	TPE	GY	FB-WWAKH4.5P3-L/S3930	8063802	8063803	8063804
	延长电缆 公头, 直型, M12	3	250V	4A	PVC	GY	FB-WASH3-L/P00	8063843	8063844	8063845	
				4A	PVC	GY	FB-WASH3-L/P01	8063715	8063716	8063717	
				4A	TPE	GY	FB-WASH3-L/S3930	8050468	8058563	8058564	
		4	250V	4A	PVC	GY	FB-WASH4-L/P00	8063837	8063838	8063839	
				4A	PVC	GY	FB-WASH4-L/P01	8063706	8063707	8063708	
				4A	TPE	GY	FB-WASH4-L/S3930	8050470	8058565	8058566	
		5	60V	4A	PVC	GY	FB-WASH4.5-L/P00	8063840	8063841	8063842	
				4A	PVC	GY	FB-WASH4.5-L/P01	8063709	8063710	8063711	
				4A	TPE	GY	FB-WASH4.5-L/S3930	8063888	8063889	8063890	

	顶端				电缆			产品描述	L = 电缆长度*		
	针脚	最大电压	最大电流	LED	材料	颜色	UL		2m / 1m	5m / 2m	10m / 5m
	3	250V	4A		PVC	GY		FB-WWASH3-L/P00	8063781	8063782	8063783
			4A		PVC	GY		FB-WWASH3-L/P01	8063663	8063664	8063665
			4A		TPE	GY		FB-WWASH3-L/S3930	8050469	8058567	8058568
	4	250V	4A		PVC	GY		FB-WWASH4-L/P00	8063775	8063776	8063777
			4A		PVC	GY		FB-WWASH4-L/P01	8063655	8063656	8063657
			4A		TPE	GY		FB-WWASH4-L/S3930	8050471	8058569	8058570
	5	60V	4A		PVC	GY		FB-WWASH4.5-L/P00	8063675	8063676	8063677
			4A		PVC	GY		FB-WWASH4.5-L/P01	8063660	8063661	8063662
			4A		TPE	GY		FB-WWASH4.5-L/S3930	8063891	8063892	8063893
	3	250V	4A		PVC	GY		FB-WAKH3-L-FB-WASH3/P00	8063852	8063853	8063854
			4A		PVC	GY		FB-WAKH3-L-FB-WASH3/P01	8063742	8063744	8063747
			4A		TPE	GY		FB-WAKH3-L-FB-WASH3/S3930	8058587	8058588	8058589
	4	250V	4A		PVC	GY		FB-WAKH4-L-FB-WASH4/P00	8063846	8063847	8063848
			4A		PVC	GY		FB-WAKH4-L-FB-WASH4/P01	8063721	8063722	8063723
			4A		TPE	GY		FB-WAKH4-L-FB-WASH4/S3930	8058590	8058591	8058592
	5	60V	4A		PVC	GY		FB-WAKH4.5-L-FB-WASH4.5/P00	8063849	8063850	8063851
			4A		PVC	GY		FB-WAKH4.5-L-FB-WASH4.5/P01	8063733	8063734	8063735
			4A		TPE	GY		FB-WAKH4.5-L-FB-WASH4.5/S3930	8063681	8063682	8063683
	3	250V	4A		PVC	GY		FB-WWAKH3-L-FB-WWASH3/P00	8063831	8063832	8063833
			4A		PVC	GY		FB-WWAKH3-L-FB-WWASH3/P01	8063697	8063698	8063699
			4A		TPE	GY		FB-WWAKH3-L-FB-WWASH3/S3930	8058593	8058594	8058595
	4	250V	4A		PVC	GY		FB-WWAKH4-L-FB-WWASH4/P00	8063793	8063794	8063795
			4A		PVC	GY		FB-WWAKH4-L-FB-WWASH4/P01	8063669	8063670	8063671
			4A		TPE	GY		FB-WWAKH4-L-FB-WWASH4/S3930	8058596	8058597	8058598
	5	60V	4A		PVC	GY		FB-WWAKH4.5-L-FB-WWASH4.5/P00	8063820	8063821	8063822
			4A		PVC	GY		FB-WWAKH4.5-L-FB-WWASH4.5/P01	8063684	8063685	8063686
			4A		TPE	GY		FB-WWAKH4.5-L-FB-WWASH4.5/S3930	8063814	8063815	8063816
	4	250V	4A					FB-FKE4-L/PG9	8068276		
	5	60V	4A					FB-FKE4.5-L/PG9	8068277		
	4	250V	4A					FB-FKE4-0,5/PG9	8068278		
	5	60V	4A					FB-FKE4.5-0,5/PG9	8068279		
	4	250V	4A					FB-FSE4-L/PG9	8068272		
	5	60V	4A					FB-FSE4.5-L/PG9	8068273		

		顶端				电缆			L = 电缆长度*			
		针脚	最大电压	最大电流	LED	材料	颜色	UL	产品描述	2m / 1m	5m / 2m	10m / 5m
	法兰公头, 直型, M12 线芯连接 前面板安装 (不带固定螺丝)	4	250V	4A					FB-FSE4-0,5/PG9	8068274		
		5	60V	4A					FB-FSE4.5-0,5/PG9	8068275		
	现场接线连接器 母头, 直型, M12 螺丝夹紧连接	5	125V	4A					WAKCE5K	8063393		
	现场接线连接器 母头, 弯型, M12 螺丝夹紧连接	5	125V	4A					WWAKCE5K	8063395		
	现场接线连接器 公头, 直型, M12 螺丝夹紧连接	5	125V	4A					WASCE5K	8063394		
	现场接线连接器 公头, 弯型, M12 螺丝夹紧连接	5	125V	4A					WWASCE5K	8063396		
	延长电缆 母头, 直型, M8	3	60V	4A		PVC	GY		FB-SKPH3-L/P00	8063690	8063653	8063691
				4A		PVC	GY		FB-SKPH3-L/P01	8063700	8063701	8063702
				4A		TPE	GY		FB-SKPH3-L/S3930	8050454	8058571	8058572
		4	60V	4A		PVC	GY		FB-SKPH4-L/P00	8063652	8063695	8063696
				4A		PVC	GY		FB-SKPH4-L/P01	8063712	8063713	8063714
				4A		TPE	GY		FB-SKPH4-L/S3930	8050455	8058573	8058574
	延长电缆 母头, 弯型, M8	3	60V	4A		PVC	GY		FB-SWKPH3-L/P00	8063718	8063719	8063720
				4A		PVC	GY		FB-SWKPH3-L/P01	8063730	8063731	8063732
				4A		TPE	GY		FB-SWKPH3-L/S3930	8050456	8058575	8058576
		4	60V	4A		PVC	GY		FB-SWKPH4-L/P00	8063726	8063727	8063729
				4A		PVC	GY		FB-SWKPH4-L/P01	8063736	8063737	8063738
				4A		TPE	GY		FB-SWKPH4-L/S3930	8050457	8058577	8058578
	延长电缆 母头, 弯型, M8, 带LED	3	30V	4A	3P2	PVC	GY		FB-SWKPH3P2-L/P00	8063743	8063745	8063746
				4A	3P2	PVC	GY		FB-SWKPH3P2-L/P01	8063761	8063763	8063765
				4A	3P2	TPE	GY		FB-SWKPH3P2-L/S3930	8058619	8058620	8058621
		4	30V	4A	4P2	PVC	GY		FB-SWKPH4P2-L/P00	8063750	8063751	8063753
				4A	4P2	PVC	GY		FB-SWKPH4P2-L/P01	8063760	8063762	8063764
				4A	4P2	TPE	GY		FB-SWKPH4P2-L/S3930	8058622	8058623	8058624



	顶端				电缆			产品描述	L = 电缆长度*		
	针脚	最大电压	最大电流	LED	材料	颜色	UL		2m / 1m	5m / 2m	10m / 5m
 延长电缆 公头, 直型, M8	3	60V	4A	PVC	GY	FB-SSPH3-L/P00	8063769	8063770	8063771		
			4A	PVC	GY	FB-SSPH3-L/P01	8063778	8063779	8063780		
			4A	TPE	GY	FB-SSPH3-L/S3930	8050458	8058579	8058580		
	4	60V	4A	PVC	GY	FB-SSPH4-L/P00	8063772	8063773	8063774		
			4A	PVC	GY	FB-SSPH4-L/P01	8063784	8063785	8063786		
			4A	TPE	GY	FB-SSPH4-L/S3930	8050459	8058581	8058582		
 延长电缆 公头, 弯型, M8	3	60V	4A	PVC	GY	FB-SWSPH3-L/P00	8063790	8063791	8063792		
			4A	PVC	GY	FB-SWSPH3-L/P01	8063757	8063758	8063759		
			4A	TPE	GY	FB-SWSPH3-L/S3930	8050460	8058583	8058584		
	4	60V	4A	PVC	GY	FB-SWSPH4-L/P00	8063796	8063797	8063798		
			4A	PVC	GY	FB-SWSPH4-L/P01	8063754	8063755	8063756		
			4A	TPE	GY	FB-SWSPH4-L/S3930	8050461	8058585	8058586		
 连接电缆 母头, 直型, M8 公头, 直型, M8	3	60V	4A	PVC	GY	FB-SKPH3-L-FB-SSPH3/P00	8063875	8063876	8063877		
			4A	PVC	GY	FB-SKPH3-L-FB-SSPH3/P01	8063864	8063865	8063866		
			4A	TPE	GY	FB-SKPH3-L-FB-SSPH3/S3930	8058599	8058600	8058601		
	4	60V	4A	PVC	GY	FB-SKPH4-L-FB-SSPH4/P00	8063861	8063862	8063863		
			4A	PVC	GY	FB-SKPH4-L-FB-SSPH4/P01	8063867	8063868	8063869		
			4A	TPE	GY	FB-SKPH4-L-FB-SSPH4/S3930	8058602	8058603	8058604		
 连接电缆 母头, 弯型, M8 公头, 弯型, M8	3	60V	4A	PVC	GY	FB-SWKPH3-L-FB-SWSPH3/P00	8063858	8063859	8063860		
			4A	PVC	GY	FB-SWKPH3-L-FB-SWSPH3/P01	8063871	8063872	8063873		
			4A	TPE	GY	FB-SWKPH3-L-FB-SWSPH3/S3930	8058605	8058606	8058607		
	4	60V	4A	PVC	GY	FB-SWKPH4-L-FB-SWSPH4/P00	8063855	8063856	8063857		
			4A	PVC	GY	FB-SWKPH4-L-FB-SWSPH4/P01	8063766	8063767	8063768		
			4A	TPE	GY	FB-SWKPH4-L-FB-SWSPH4/S3930	8058608	8058609	8058610		

标准连接器的长度:2米,5米,或10米。中继电缆长度:1米,2米或5米。法兰面板安装的电线长度:0.5米(0.2米)。其他电缆,电线长度可按照客户要求定制。

对接连接器命名

连接电缆

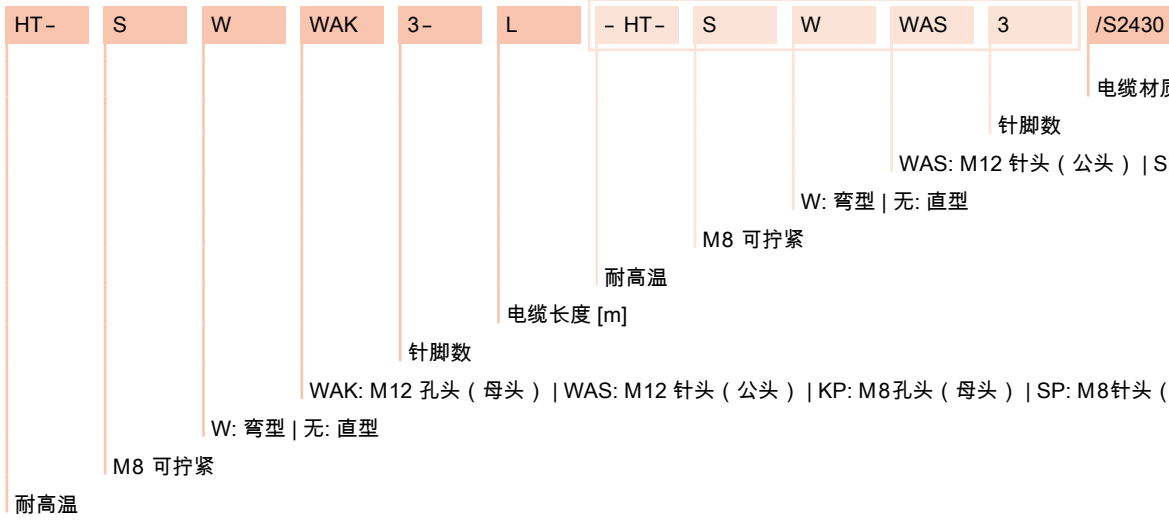













电缆	材料	UL	颜色	特性
S2430	PTFE/PTFE		WH	-190°C...+260°C

高温







技术参数	M12	M8	法兰连接
绝缘电阻	≥10 <sup>8</sup> Ω	≥10 <sup>8</sup> Ω	≥10 <sup>8</sup> Ω
电阻	≤ 5mΩ	≤ 5mΩ	≤ 5mΩ
产品环境温度	-20°C...+150°C	-20°C...+150°C	-20°C...+150°C
触点材料	合金, 镀金	合金, 镀金	合金, 镀金
触头载体材料	塑料, PBT GF	塑料, PBT GF	塑料, PBT GF
夹紧基体材料	塑料, PBT GF	塑料, PBT GF	
连接螺母材料	合金, 铜锌, 镀镍	合金, 铜锌, 镀镍	
密封(母头)材料	FPM/FKM	FPM/FKM	FPM/FKM
防护密封件材料			FPM/FKM
插座外壳材料			合金, 铜锌, 镀镍
标准	IEC 61076-2-101	IEC 61076-2-104	IEC 61076-2-101
防护等级 (安装好)	IP65	IP65	IP65, IP67, IP68
机械寿命周期	>100 插拔次数	>100 插拔次数	>100 插拔次数
污染等级	3	3	3

因为抗高温材料，即使在极端高温的应用场合下，我们M8和M12连接器也保证了可靠的运行模式。长期运行温度在-20°C...+150°C，而且即使在短期最高运行温度+200°C也不会对此类产品造成问题。

		顶端			电缆			L = 电缆长度*				
		针脚	最大电压	特殊	材料	颜色	UL	产品描述	2m / 1m	5m / 2m	10m / 5m	
	延长电缆 母头, 直型, M12	3	250V	4A	PTFE	WH		HT-WAK3-L/S2430	8039210	8036085	8039211	
		4	250V	4A	PTFE	WH		HT-WAK4-L/S2430	8036518	8036086	8036154	
		5	60V	4A	PTFE	WH		HT-WAK4.5-L/S2430	8039212	8036087	8039213	
	延长电缆 母头, 弯型, M12	3	250V	4A	PTFE	WH		HT-WWAK3-L/S2430	8039224	8036088	8039225	
		4	250V	4A	PTFE	WH		HT-WWAK4-L/S2430	8039226	8036089	8037214	
		5	60V	4A	PTFE	WH		HT-WWAK4.5-L/S2430	8039227	8036090	8039228	
	延长电缆 公头, 直型, M12	3	250V	4A	PTFE	WH		HT-WAS3-L/S2430	8039231	8036091	8039232	
		4	250V	4A	PTFE	WH		HT-WAS4-L/S2430	8039233	8036092	8039234	
		5	60V	4A	PTFE	WH		HT-WAS4.5-L/S2430	8039235	8036093	8038342	
	延长电缆 公头, 弯型, M12	3	250V	4A	PTFE	WH		HT-WWAS3-L/S2430	8039467	8036094	8039468	
		4	250V	4A	PTFE	WH		HT-WWAS4-L/S2430	8039469	8036095	8039470	
		5	60V	4A	PTFE	WH		HT-WWAS4.5-L/S2430	8039471	8036096	8039472	
	连接电缆 母头, 直型, M12	3	250V	4A	PTFE	WH		HT-WAK3-L-HT-WAS3/S2430	8036254	8039479	8039480	
			4	250V	4A	PTFE	WH		HT-WAK4-L-HT-WAS4/S2430	8038667	8038668	8038669
			5	60V	4A	PTFE	WH		HT-WAK4.5-L-HT-WAS4.5/S2430	8051958	8039949	8039950
	连接电缆 母头, 弯型, M12	3	250V	4A	PTFE	WH		HT-WWAK3-L-HT-WWAS3/S2430	8051956	8039958	8039959	
			4	250V	4A	PTFE	WH		HT-WWAK4-L-HT-WWAS4/S2430	8051957	8039961	8039137
			5	60V	4A	PTFE	WH		HT-WWAK4.5-L-HT-WWAS4.5/S2430	8051959	8039963	8039964
	法兰 母头, 直型, M12 线芯连接 前面板安装 ( 不带固定螺丝 )	3	250V	4A				HT-FK3-0,5/16/S2470	8037311			
		4	250V	4A				HT-FK4-0,5/16/S2470	8037322			
		5	60V	4A				HT-FK4.5-0,5/16/S2470	8037323			
	法兰 公头, 直型, M12 线芯连接 前面板安装 ( 不带固定螺丝 )	3	250V	4A				HT-FS3-0,5/16/S2470	8037288			
		4	250V	4A				HT-FS4-0,5/16/S2470	8037292			
		5	60V	4A				HT-FS4.5-0,5/16/S2470	8037293			
	延长电缆 母头, 直型, M8	3	60V	4A	PTFE	WH		HT-SKP3-L/S2430	8036605	8036097	8039482	
		4	60V	4A	PTFE	WH		HT-SKP4-L/S2430	8039483	8036098	8037215	
	延长电缆 母头, 弯型, M8	3	60V	4A	PTFE	WH		HT-SWKP3-L/S2430	8039484	8036099	8039485	
		4	60V	4A	PTFE	WH		HT-SWKP4-L/S2430	8039486	8036100	8037216	
	延长电缆 公头, 直型, M8	3	60V	4A	PTFE	WH		HT-SSP3-L/S2430	8039487	8036101	8039488	
		4	60V	4A	PTFE	WH		HT-SSP4-L/S2430	8039489	8036102	8039490	

标准连接器的长度:2米,5米,或10米。中继电缆长度:1米,2米或5米。法兰面板安装的电线长度:0.5米(0.2米)。其他电缆,电线长度可按照客户要求定制。

		顶端			电缆			L = 电缆长度*			
		针脚	最大电压	特殊	材料	颜色	UL	产品描述	2m / 1m	5m / 2m	10m / 5m
	延长电缆 公头, 弯型, M8	3	60V	4A	PTFE	WH		HT-SWSP3-L/S2430	8039491	8036103	8039492
		4	60V	4A	PTFE	WH		HT-SWSP4-L/S2430	8039493	8036104	8039494
	连接电缆 母头, 直型, M8	3	60V	4A	PTFE	WH		HT-SKP3-L-HT-SSP3/S2430	8043355	8039972	8039973
		4	60V	4A	PTFE	WH		HT-SKP4-L-HT-SSP4/S2430	8051990	8039975	8039976
	连接电缆 母头, 弯型, M8	3	60V	4A	PTFE	WH		HT-SWKP3-L-HT-SWSP3/S2430	8051991	8039978	8039979
		4	60V	4A	PTFE	WH		HT-SWKP4-L-HT-SWSP4/S2430	8051992	8039981	8039982
	连接电缆 公头, 弯型, M8										

高温

标准连接器的长度:2米,5米,或10米。中继电缆长度:1米,2米或5米。法兰面板安装的电线长度:0.5米(0.2米)。其他电缆,电线长度可按照客户要求定制。

命名

AL-	FV	M12	E	S	S	A	3.xxx	P/	M16	S520
										可定位的 拧紧螺纹 M16x1.5
										P: PC板-连接   L: 焊接连接   0.5: 电缆-长度 [m]
										触点分布编码
										类编码
										S: 屏蔽防护   U: 非屏蔽防护
										S: 针头 (公头)   K: 孔头 (母头)
										不锈钢
										M12: M12   M8: M8
										FV: 法兰 前面板安装   FH: 法兰 后面板安装
										产品系列

通过进一步开发面向平台的面板连接器和插座，我们修改了我们的命名规则。为了方便大家，除了前面和现在仍然有效的命名法(如下)，我们还对新的命名法进行了说明(如上)。

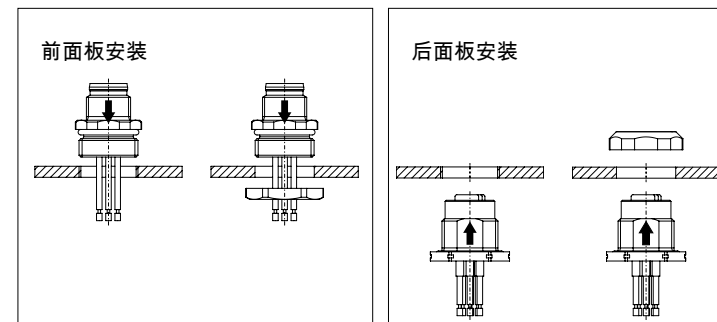

IE-	W	FK	F	D	E	S	X	8-	F	L	/ 16	/ S3500	/ S3525
													另外：壁厚补偿或触头载体颜色
													电缆材质
													锁紧螺纹 16: M16x1.5   12: M12
													电缆长度/电缆-长度[m]
													F: M8x1 前端法兰 (后-面板 安装)
													针脚数
													类编码
													屏蔽防护
													E: 不锈钢 1.4404   无: 铜锌，镀镍
													可调节的
													F: M12 前端法兰 (后-面板 安装)   S: M8: 可拧紧
													FK: 孔头 (母头)   FS: 针头 (公头)
													W: 弯型   无: 直型
													产品系列



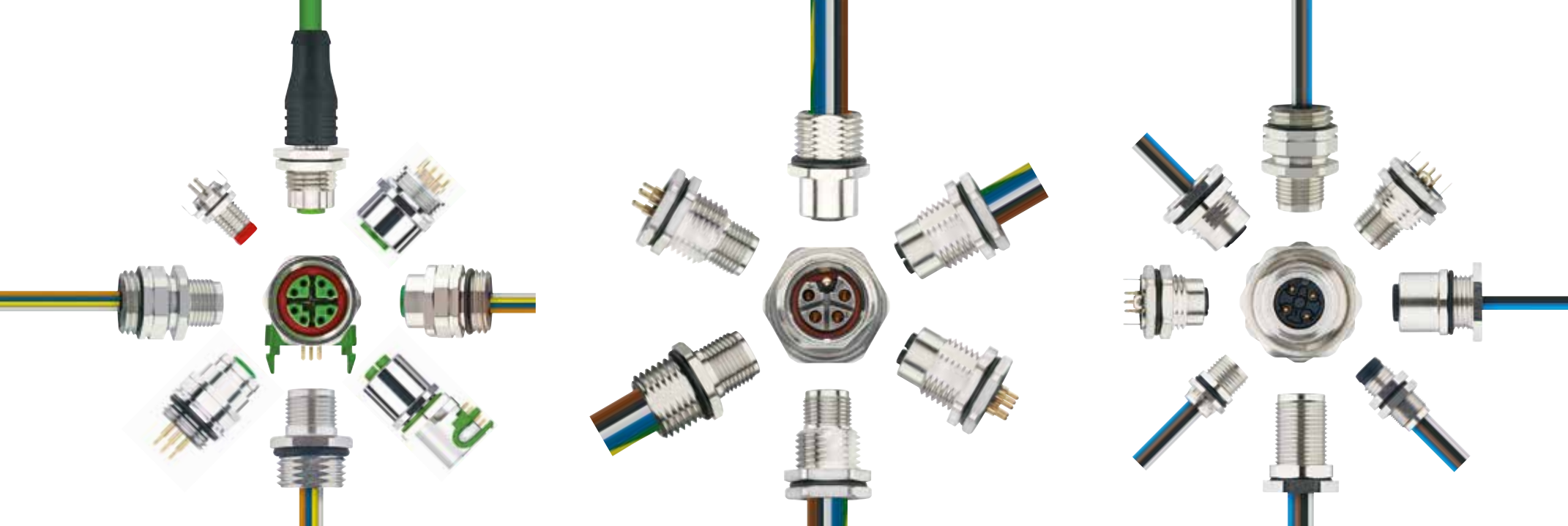

## 法兰连接

技术参数	法兰 M12	法兰 M8	面板式连接器 M12	面板式连接器 M8	面板式连接器 8mm快插
绝缘电阻	$\geq 10^9 \Omega$	$\geq 10^9 \Omega$	$\geq 10^9 \Omega$	$\geq 10^9 \Omega$	$\geq 10^9 \Omega$
电阻	$\leq 5 m\Omega$	$\leq 5 m\Omega$	$\leq 5 m\Omega$	$\leq 5 m\Omega$	$\leq 5 m\Omega$
产品环境温度	-30°C...+90°C	-30°C...+90°C	-30°C...+90°C	-30°C...+90°C	-30°C...+90°C
触点材料	合金, 镀金	合金, 镀金	合金, 镀金	合金, 镀金	合金, 镀金
触头载体材料	塑料	塑料	塑料	塑料	塑料, PA
插座外壳材料	合金, 不锈钢	合金, 不锈钢			
标准	IEC 61076-2-101	IEC 61076-2-104	IEC 61076-2-101	IEC 61076-2-104	IEC 61076-2-104
防护等级 (安装好)	IP65, IP67, IP68	IP65, IP67, IP68	IP65, IP67	IP65, IP67	IP65, IP67
机械寿命周期	>100 插拔次数	>100 插拔次数	>100 插拔次数	>100 插拔次数	>100 插拔次数
污染等级	3	3/2	3/2	3/2	3/2

	针脚	编码	最大电压	最大电流 UL	L [m]	Δh[mm]	插座外壳材料	锁紧螺纹	产品描述	物料编号
 <p>传感器执行器 母头, 直型, M12 前面板安装 (不带固定螺丝) 线芯连接</p>	3	A	250V	4 A	•	0.50	合金, 铜锌, 镀镍	M12x1	AL-FVM12KUA3-0,5/M12	8071727
								M16x1.5	AL-FVM12KUA3-0,5/M16	8071679
								PG9	AL-FVM12KUA3-0,5/PG9	8072461
							不锈钢 1.4404	M16x1.5	AL-FVM12EKUA3-0,5/M16	8082880
								PG9	AL-FVM12EKUA3-0,5/PG9	8082892
	4	A	250V	4 A	•	0.50	合金, 铜锌, 镀镍	M12x1	AL-FVM12KUA4-0,5/M12	8071730
								M16x1.5	AL-FVM12KUA4-0,5/M16	8071682
								PG9	AL-FVM12KUA4-0,5/PG9	8072462
							不锈钢 1.4404	M16x1.5	AL-FVM12EKUA4-0,5/M16	8082881
								PG9	AL-FVM12EKUA4-0,5/PG9	8082893
4+PE	A	60V	4 A	•	0.50	合金, 铜锌, 镀镍	M12x1	AL-FVM12KUA5-0,5/M12	8071738	
							M16x1.5	AL-FVM12KUA5-0,5/M16	8071693	
							PG9	AL-FVM12KUA5-0,5/PG9	8072467	
						不锈钢 1.4404	M16x1.5	AL-FVM12EKUA5-0,5/M16	8082887	
							PG9	AL-FVM12EKUA5-0,5/PG9	8082899	
5	A	60V	4 A	•	0.50	合金, 铜锌, 镀镍	M12x1	AL-FVM12KUA4.5-0,5/M12	8071734	
							M16x1.5	AL-FVM12KUA4.5-0,5/M16	8071691	
							PG9	AL-FVM12KUA4.5-0,5/PG9	8072465	
						不锈钢 1.4404	M16x1.5	AL-FVM12EKUA4.5-0,5/M16	8082885	
							PG9	AL-FVM12EKUA4.5-0,5/PG9	8082897	
8	A	30V	2 A	•	0.50	合金, 铜锌, 镀镍	M12x1	AL-FVM12KUA8-0,5/M12	8071740	
							M16x1.5	AL-FVM12KUA8-0,5/M16	8071695	
							PG9	AL-FVM12KUA8-0,5/PG9	8072469	
						不锈钢 1.4404	M16x1.5	AL-FVM12EKUA8-0,5/M16	8082890	
							PG9	AL-FVM12EKUA8-0,5/PG9	8082906	
12	A	30V	1.5 A	•	0.50	合金, 铜锌, 镀镍	M12x1	AL-FVM12KUA12-0,5/M12	8071742	
							M16x1.5	AL-FVM12KUA12-0,5/M16	8071696	
							PG9	AL-FVM12KUA12-0,5/PG9	8072470	
						不锈钢 1.4404	M16x1.5	AL-FVM12EKUA12-0,5/M16	8082891	
							PG9	AL-FVM12EKUA12-0,5/PG9	8082907	





传感器执行器  
母头,直型, M12  
前面板安装,可定位的  
线芯连接

针脚	编码	最大电压	最大电流 UL	L [m]	Δh[mm]	插座外壳材料	锁紧螺纹	产品描述	物料编号
3	A	250V	4 A	•	0.50	合金, 铜锌, 镀镍	M16x1.5	AL-FVM12KUA3-0,5/M16/S520	8077913
							PG9	AL-FVM12KUA3-0,5/PG9/S520	8077917
						不锈钢 1.4404	M16x1.5	AL-FVM12EKUA3-0,5/M16/S520	8082908
4	A	250V	4 A	•	0.50	合金, 铜锌, 镀镍	M16x1.5	AL-FVM12KUA4-0,5/M16/S520	8077902
							PG9	AL-FVM12KUA4-0,5/PG9/S520	8077918
						不锈钢 1.4404	M16x1.5	AL-FVM12EKUA4-0,5/M16/S520	8082909
4+PE	A	60V	4 A	•	0.50	合金, 铜锌, 镀镍	M16x1.5	AL-FVM12KUA5-0,5/M16/S520	8077908
							PG9	AL-FVM12KUA5-0,5/PG9/S520	8077924
						不锈钢 1.4404	M16x1.5	AL-FVM12EKUA5-0,5/M16/S520	8082915
5	A	60V	4 A	•	0.50	合金, 铜锌, 镀镍	M16x1.5	AL-FVM12KUA4.5-0,5/M16/S520	8077906
							PG9	AL-FVM12KUA4.5-0,5/PG9/S520	8077922
						不锈钢 1.4404	M16x1.5	AL-FVM12EKUA4.5-0,5/M16/S520	8082913
8	A	30V	2 A	•	0.50	合金, 铜锌, 镀镍	M16x1.5	AL-FVM12KUA8-0,5/M16/S520	8077911
							PG9	AL-FVM12KUA8-0,5/PG9/S520	8077927
						不锈钢 1.4404	M16x1.5	AL-FVM12EKUA8-0,5/M16/S520	8082918
12	A	30V	1.5 A	•	0.50	合金, 铜锌, 镀镍	M16x1.5	AL-FVM12KUA12-0,5/M16/S520	8077912
							PG9	AL-FVM12KUA12-0,5/PG9/S520	8077928
						不锈钢 1.4404	M16x1.5	AL-FVM12EKUA12-0,5/M16/S520	8082919

	针脚	编码	最大电压	最大电流 UL	L [m]	Δh[mm]	插座外壳材料	锁紧螺纹	产品描述	物料编号
 <p>传感器执行器 公头, 直型, M12 前面板安装 ( 不带固定螺丝 ) 线芯连接</p>	3	A	250V	4 A	•	0.50	合金, 铜锌, 镀镍	M12x1	AL-FVM12SUA3-0,5/M12	8071831
								M16x1.5	AL-FVM12SUA3-0,5/M16	8071801
								PG9	AL-FVM12SUA3-0,5/PG9	8072486
							不锈钢 1.4404	M16x1.5	AL-FVM12ESUA3-0,5/M16	8082990
								PG9	AL-FVM12ESUA3-0,5/PG9	8083002
	4	A	250V	4 A	•	0.50	合金, 铜锌, 镀镍	M12x1	AL-FVM12SUA4-0,5/M12	8071832
								M16x1.5	AL-FVM12SUA4-0,5/M16	8071802
								PG9	AL-FVM12SUA4-0,5/PG9	8072487
							不锈钢 1.4404	M16x1.5	AL-FVM12ESUA4-0,5/M16	8082991
								PG9	AL-FVM12ESUA4-0,5/PG9	8083019
4+PE	A	60V	4 A	•	0.50	合金, 铜锌, 镀镍	M12x1	AL-FVM12SUA5-0,5/M12	8071837	
							M16x1.5	AL-FVM12SUA5-0,5/M16	8071808	
							PG9	AL-FVM12SUA5-0,5/PG9	8072492	
						不锈钢 1.4404	M16x1.5	AL-FVM12ESUA5-0,5/M16	8082998	
							PG9	AL-FVM12ESUA5-0,5/PG9	8083026	
5	A	60V	4 A	•	0.50	合金, 铜锌, 镀镍	M12x1	AL-FVM12SUA4.5-0,5/M12	8071835	
							M16x1.5	AL-FVM12SUA4.5-0,5/M16	8071805	
							PG9	AL-FVM12SUA4.5-0,5/PG9	8072490	
						不锈钢 1.4404	M16x1.5	AL-FVM12ESUA4.5-0,5/M16	8082995	
							PG9	AL-FVM12ESUA4.5-0,5/PG9	8083023	
8	A	30V	2 A	•	0.50	合金, 铜锌, 镀镍	M12x1	AL-FVM12SUA8-0,5/M12	8071839	
							M16x1.5	AL-FVM12SUA8-0,5/M16	8071810	
							PG9	AL-FVM12SUA8-0,5/PG9	8072494	
						不锈钢 1.4404	M16x1.5	AL-FVM12ESUA8-0,5/M16	8083000	
							PG9	AL-FVM12ESUA8-0,5/PG9	8083028	
12	A	30V	1.5 A	•	0.50	合金, 铜锌, 镀镍	M12x1	AL-FVM12SUA12-0,5/M12	8071840	
							M16x1.5	AL-FVM12SUA12-0,5/M16	8071811	
							PG9	AL-FVM12SUA12-0,5/PG9	8072495	
						不锈钢 1.4404	M16x1.5	AL-FVM12ESUA12-0,5/M16	8083001	
							PG9	AL-FVM12ESUA12-0,5/PG9	8083029	







传感器执行器  
公头, 直型, M12  
前面板安装, 可定位的  
线芯连接











针脚	编码	最大电压	最大电流 UL	L [m]	Δh[mm]	插座外壳材料	锁紧螺纹	产品描述	物料编号
3	A	250V	4 A	•	0.50	合金, 铜锌, 镀镍	M16x1.5	AL-FVM12SUA3-0,5/M16/S520	8077964
							PG9	AL-FVM12SUA3-0,5/PG9/S520	8078052
						不锈钢 1.4404	M16x1.5	AL-FVM12ESUA3-0,5/M16/S520	8083030
4	A	250V	4 A	•	0.50	合金, 铜锌, 镀镍	M16x1.5	AL-FVM12SUA4-0,5/M16/S520	8077965
							PG9	AL-FVM12SUA4-0,5/PG9/S520	8078053
						不锈钢 1.4404	M16x1.5	AL-FVM12ESUA4-0,5/M16/S520	8083031
4+PE	A	60V	4 A	•	0.50	合金, 铜锌, 镀镍	M16x1.5	AL-FVM12SUA5-0,5/M16/S520	8077972
							PG9	AL-FVM12SUA5-0,5/PG9/S520	8078060
						不锈钢 1.4404	M16x1.5	AL-FVM12ESUA5-0,5/M16/S520	8083038
5	A	60V	4 A	•	0.50	合金, 铜锌, 镀镍	M16x1.5	AL-FVM12SUA4.5-0,5/M16/S520	8077969
							PG9	AL-FVM12SUA4.5-0,5/PG9/S520	8078057
						不锈钢 1.4404	M16x1.5	AL-FVM12ESUA4.5-0,5/M16/S520	8083035
8	A	30V	2 A	•	0.50	合金, 铜锌, 镀镍	M16x1.5	AL-FVM12SUA8-0,5/M16/S520	8077974
							PG9	AL-FVM12SUA8-0,5/PG9/S520	8078062
						不锈钢 1.4404	M16x1.5	AL-FVM12ESUA8-0,5/M16/S520	8083040
12	A	30V	1.5 A	•	0.50	合金, 铜锌, 镀镍	M16x1.5	AL-FVM12SUA12-0,5/M16/S520	8077975
							PG9	AL-FVM12SUA12-0,5/PG9/S520	8078063
						不锈钢 1.4404	M16x1.5	AL-FVM12ESUA12-0,5/M16/S520	8083041

	针脚	编码	最大电压	最大电流 UL	L [m]	Δh[mm]	插座外壳材料	锁紧螺纹	产品描述	物料编号						
 传感器执行器 母头, 直型, M12 后面板安装 (带固定螺丝) 线芯连接	3	A	250V	4 A	•	0.50	合金, 铜锌, 镀镍	PG9	AL-FHM12KUA3-0,5/PG9	8072450						
								M16x1.5	AL-FHM12KUA3-0,5/M16	8071533						
							不锈钢 1.4404	M16x1.5	AL-FHM12EKUA3-0,5/M16	8082719						
							1,0...2,5	合金, 铜锌, 镀镍	M12x1	AL-FHM12KUA3-0,5/M12/S3525	8076756					
							2,5...4,0	合金, 铜锌, 镀镍	M12x1	AL-FHM12KUA3-0,5/M12/S3540	8076742					
							4,0...5,0	合金, 铜锌, 镀镍	M12x1	AL-FHM12KUA3-0,5/M12/S3550	8071705					
							4	A	250V	4 A	•	0.50	合金, 铜锌, 镀镍	M16x1.5	AL-FHM12KUA4-0,5/M16	8071536
														PG9	AL-FHM12KUA4-0,5/PG9	8072451
													不锈钢 1.4404	M16x1.5	AL-FHM12EKUA4-0,5/M16	8082720
													1,0...2,5	合金, 铜锌, 镀镍	M12x1	AL-FHM12KUA4-0,5/M12/S3525
	2,5...4,0	合金, 铜锌, 镀镍	M12x1	AL-FHM12KUA4-0,5/M12/S3540	8076794											
	4+PE	A	60V	4 A	•	0.50	合金, 铜锌, 镀镍	M16x1.5	AL-FHM12KUA5-0,5/M16	8071666						
								PG9	AL-FHM12KUA5-0,5/PG9	8072456						
							不锈钢 1.4404	M16x1.5	AL-FHM12EKUA5-0,5/M16	8082726						
							1,0...2,5	合金, 铜锌, 镀镍	M12x1	AL-FHM12KUA5-0,5/M12/S3525	8076808					
							2,5...4,0	合金, 铜锌, 镀镍	M12x1	AL-FHM12KUA5-0,5/M12/S3540	8076807					
	5	A	60V	4 A	•	0.50	合金, 铜锌, 镀镍	PG9	AL-FHM12KUA4.5-0,5/PG9	8072454						
								M16x1.5	AL-FHM12KUA4.5-0,5/M16	8071540						
							不锈钢 1.4404	M16x1.5	AL-FHM12EKUA4.5-0,5/M16	8082724						
							1,0...2,5	合金, 铜锌, 镀镍	M12x1	AL-FHM12KUA4.5-0,5/M12/S3525	8076801					
2,5...4,0							合金, 铜锌, 镀镍	M12x1	AL-FHM12KUA4.5-0,5/M12/S3540	8076800						
8	A	30V	2 A	•	0.50	合金, 铜锌, 镀镍	M16x1.5	AL-FHM12KUA8-0,5/M16	8071668							
							PG9	AL-FHM12KUA8-0,5/PG9	8072458							
						不锈钢 1.4404	M16x1.5	AL-FHM12EKUA8-0,5/M16	8082729							
						1,0...2,5	合金, 铜锌, 镀镍	M12x1	AL-FHM12KUA8-0,5/M12/S3525	8076825						
						2,5...4,0	合金, 铜锌, 镀镍	M12x1	AL-FHM12KUA8-0,5/M12/S3540	8076824						
12	A	30V	1.5 A	•	0.50	合金, 铜锌, 镀镍	M16x1.5	AL-FHM12KUA12-0,5/M16	8071669							
							PG9	AL-FHM12KUA12-0,5/PG9	8072459							
						不锈钢 1.4404	M16x1.5	AL-FHM12EKUA12-0,5/M16	8082730							
						1,0...2,5	合金, 铜锌, 镀镍	M12x1	AL-FHM12KUA12-0,5/M12/S3525	8076827						
						2,5...4,0	合金, 铜锌, 镀镍	M12x1	AL-FHM12KUA12-0,5/M12/S3540	8076826						
			4,0...5,0	合金, 铜锌, 镀镍	M12x1	AL-FHM12KUA12-0,5/M12/S3550	8071718									











	针脚	编码	最大电压	最大电流 UL	L [m]	Δh[mm]	插座外壳材料	锁紧螺纹	产品描述	物料编号						
 传感器执行器 母头, 直型, M12 后面板安装 (带固定螺丝) PC板-连接	3	A	250V	4 A	•		合金, 铜锌, 镀镍	M16x1.5	AL-FHM12KUA3-P/M16	8072160						
								PG9	AL-FHM12KUA3-P/PG9	8072173						
							不锈钢 1.4404	M16x1.5	AL-FHM12EKUA3-P/M16	8084910						
							1,0...2,5	合金, 铜锌, 镀镍	M12x1	AL-FHM12KUA3-P/M12/S3525	8076558					
							2,5...4,0	合金, 铜锌, 镀镍	M12x1	AL-FHM12KUA3-P/M12/S3540	8076557					
							4,0...5,0	合金, 铜锌, 镀镍	M12x1	AL-FHM12KUA3-P/M12/S3550	8072202					
							4	A	250V	4 A	•		合金, 铜锌, 镀镍	M16x1.5	AL-FHM12KUA4-P/M16	8072162
														PG9	AL-FHM12KUA4-P/PG9	8072174
													不锈钢 1.4404	M16x1.5	AL-FHM12EKUA4-P/M16	8084911
	1,0...2,5	合金, 铜锌, 镀镍	M12x1	AL-FHM12KUA4-P/M12/S3525	8076560											
	2,5...4,0	合金, 铜锌, 镀镍	M12x1	AL-FHM12KUA4-P/M12/S3540	8076559											
	4,0...5,0	合金, 铜锌, 镀镍	M12x1	AL-FHM12KUA4-P/M12/S3550	8072203											
	4+PE	A	60V	4 A	•								合金, 铜锌, 镀镍	M16x1.5	AL-FHM12KUA5-P/M16	8072168
														PG9	AL-FHM12KUA5-P/PG9	8072177
													不锈钢 1.4404	M16x1.5	AL-FHM12EKUA5-P/M16	8084924
							1,0...2,5	合金, 铜锌, 镀镍	M12x1	AL-FHM12KUA5-P/M12/S3525	8076566					
							2,5...4,0	合金, 铜锌, 镀镍	M12x1	AL-FHM12KUA5-P/M12/S3540	8076565					
							4,0...5,0	合金, 铜锌, 镀镍	M12x1	AL-FHM12KUA5-P/M12/S3550	8072206					
							8	A	30V	2 A	•		合金, 铜锌, 镀镍	M16x1.5	AL-FHM12KUA8-P/M16	8072170
														PG9	AL-FHM12KUA8-P/PG9	8072179
													不锈钢 1.4404	M16x1.5	AL-FHM12EKUA8-P/M16	8084930
1,0...2,5	合金, 铜锌, 镀镍	M12x1	AL-FHM12KUA8-P/M12/S3525	8076570												
2,5...4,0	合金, 铜锌, 镀镍	M12x1	AL-FHM12KUA8-P/M12/S3540	8076569												
4,0...5,0	合金, 铜锌, 镀镍	M12x1	AL-FHM12KUA8-P/M12/S3550	8072208												
12	A	30V	1.5 A	•		合金, 铜锌, 镀镍							M16x1.5	AL-FHM12KUA12-P/M16	8072171	
													PG9	AL-FHM12KUA12-P/PG9	8072180	
						不锈钢 1.4404							M16x1.5	AL-FHM12EKUA12-P/M16	8084932	
						1,0...2,5	合金, 铜锌, 镀镍	M12x1	AL-FHM12KUA12-P/M12/S3525	8076572						
						2,5...4,0	合金, 铜锌, 镀镍	M12x1	AL-FHM12KUA12-P/M12/S3540	8076571						
						4,0...5,0	合金, 铜锌, 镀镍	M12x1	AL-FHM12KUA12-P/M12/S3550	8072209						











	针脚	编码	最大电压	最大电流 UL	L [m]	Δh[mm]	插座外壳材料	锁紧螺纹	产品描述	物料编号
 传感器执行器 母头, 直型, M12 后面板安装 (带固定螺丝) PC板-连接 屏蔽	3	A	250V	4 A	•		合金, 铜锌, 镀镍	M16x1.5	AL-FHM12KSA3-P/M16	8072214
								PG9	AL-FHM12KSA3-P/PG9	8072239
	4	A	250V	4 A	•		合金, 铜锌, 镀镍	PG9	AL-FHM12KSA4-P/PG9	8072240
								M16x1.5	AL-FHM12KSA4-P/M16	8072215
	4+PE	A	60V	4 A	•		合金, 铜锌, 镀镍	PG9	AL-FHM12KSA5-P/PG9	8072243
								M16x1.5	AL-FHM12KSA5-P/M16	8072218
	8	A	30V	2 A	•		合金, 铜锌, 镀镍	M16x1.5	AL-FHM12KSA8-P/M16	8088765
								PG9	AL-FHM12KSA8-P/PG9	8088766
	12	A	30V	1.5 A	•		合金, 铜锌, 镀镍	M16x1.5	AL-FHM12KSA12-P/M16	8088767
								PG9	AL-FHM12KSA12-P/PG9	8088768
 传感器执行器 公头, 直型, M12 后面板安装 (带固定螺丝) 线芯连接	3	A	250V	4 A	•	0.50	合金, 铜锌, 镀镍	M12x1	AL-FHM12SUA3-0,5/M12	8071819
								M16x1.5	AL-FHM12SUA3-0,5/M16	8071790
								PG9	AL-FHM12SUA3-0,5/PG9	8072475
							不锈钢 1.4404	M16x1.5	AL-FHM12ESUA3-0,5/M16	8082977
	4	A	250V	4 A	•	0.50	合金, 铜锌, 镀镍	M12x1	AL-FHM12SUA4-0,5/M12	8071820
								M16x1.5	AL-FHM12SUA4-0,5/M16	8071791
								PG9	AL-FHM12SUA4-0,5/PG9	8072476
							不锈钢 1.4404	M16x1.5	AL-FHM12ESUA4-0,5/M16	8082978
	4+PE	A	60V	4 A	•	0.50	合金, 铜锌, 镀镍	M12x1	AL-FHM12SUA5-0,5/M12	8071825
								M16x1.5	AL-FHM12SUA5-0,5/M16	8071796
								PG9	AL-FHM12SUA5-0,5/PG9	8072481
							不锈钢 1.4404	M16x1.5	AL-FHM12ESUA5-0,5/M16	8082985
	5	A	60V	4 A	•	0.50	合金, 铜锌, 镀镍	M12x1	AL-FHM12SUA4.5-0,5/M12	8071823
								M16x1.5	AL-FHM12SUA4.5-0,5/M16	8071794
								PG9	AL-FHM12SUA4.5-0,5/PG9	8072479
							不锈钢 1.4404	M16x1.5	AL-FHM12ESUA4.5-0,5/M16	8082982
	8	A	30V	2 A	•	0.50	合金, 铜锌, 镀镍	M12x1	AL-FHM12SUA8-0,5/M12	8071827
								M16x1.5	AL-FHM12SUA8-0,5/M16	8071799
							PG9	AL-FHM12SUA8-0,5/PG9	8072483	
						不锈钢 1.4404	M16x1.5	AL-FHM12ESUA8-0,5/M16	8082987	
12	A	30V	1.5 A	•	0.50	合金, 铜锌, 镀镍	M12x1	AL-FHM12SUA12-0,5/M12	8071829	
							M16x1.5	AL-FHM12SUA12-0,5/M16	8071800	
							PG9	AL-FHM12SUA12-0,5/PG9	8072484	
						不锈钢 1.4404	M16x1.5	AL-FHM12ESUA12-0,5/M16	8082988	









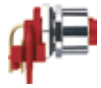

	针脚	编码	最大电压	最大电流 UL	L [m]	Δh[mm]	插座外壳材料	锁紧螺纹	产品描述	物料编号	
 传感器执行器 公头, 直型, M12 后面板安装 (带固定螺丝) PC板-连接	3	A	250V	4 A	•		合金, 铜锌, 镀镍	M12x1	AL-FHM12SUA3-P/M12	8072370	
								M16x1.5	AL-FHM12SUA3-P/M16	8072348	
								PG9	AL-FHM12SUA3-P/PG9	8072360	
		4	A	250V	4 A	•		合金, 铜锌, 镀镍	M12x1	AL-FHM12SUA4-P/M12	8072371
									M16x1.5	AL-FHM12SUA4-P/M16	8072349
									PG9	AL-FHM12SUA4-P/PG9	8072361
		4+PE	A	60V	4 A	•		合金, 铜锌, 镀镍	M12x1	AL-FHM12SUA5-P/M12	8072376
									M16x1.5	AL-FHM12SUA5-P/M16	8072354
									PG9	AL-FHM12SUA5-P/PG9	8072366
		5	A	60V	4 A	•		合金, 铜锌, 镀镍	M12x1	AL-FHM12SUA4.5-P/M12	8072374
									M16x1.5	AL-FHM12SUA4.5-P/M16	8072352
									PG9	AL-FHM12SUA4.5-P/PG9	8072364
	8	A	30V	2 A	•		合金, 铜锌, 镀镍	M12x1	AL-FHM12SUA8-P/M12	8072378	
								M16x1.5	AL-FHM12SUA8-P/M16	8072356	
								PG9	AL-FHM12SUA8-P/PG9	8072368	
	12	A	30V	1.5 A	•		合金, 铜锌, 镀镍	M12x1	AL-FHM12SUA12-P/M12	8072379	
								M16x1.5	AL-FHM12SUA12-P/M16	8072357	
								PG9	AL-FHM12SUA12-P/PG9	8072369	
 传感器执行器 公头, 直型, M12 后面板安装 (带固定螺丝) PC板-连接 屏蔽	3	A	250V	4 A	•		合金, 铜锌, 镀镍	M16x1.5	AL-FHM12SSA3-P/M16	8072380	
								PG9	AL-FHM12SSA3-P/PG9	8072388	
								4	A	250V	4 A
	M16x1.5	AL-FHM12SSA4-P/M16	8072381								
	4+PE	A	60V	4 A	•		合金, 铜锌, 镀镍	M16x1.5	AL-FHM12SSA5-P/M16	8072386	
								PG9	AL-FHM12SSA5-P/PG9	8072394	
	5	A	60V	4 A	•		合金, 铜锌, 镀镍	M16x1.5	AL-FHM12SSA4.5-P/M16	8072384	
								PG9	AL-FHM12SSA4.5-P/PG9	8072392	
	8	A	30V	2 A	•		合金, 铜锌, 镀镍	M16x1.5	AL-FHM12SSA8-P/M16	8088769	
								PG9	AL-FHM12SSA8-P/PG9	8088770	
	12	A	30V	1.5 A	•		合金, 铜锌, 镀镍	M16x1.5	AL-FHM12SSA12-P/M16	8088771	
								PG9	AL-FHM12SSA12-P/PG9	8088772	











		针脚	编码	最大电压	最大电流 UL	L [m]	Δh[mm]	插座外壳材料	锁紧螺纹	产品描述	物料编号
	传感器执行器 母头, 弯型, M12 后面板安装 (带固定螺丝) PC板-连接	4	A	250V	4 A	•	1,0...2,5	合金, 铜锌, 镀镍		EC-WFKF4-P/12/S3525	8050275
							2,5...4,0	合金, 铜锌, 镀镍		EC-WFKF4-P/12/S3540	8050274
							4,0...5,0	合金, 铜锌, 镀镍		EC-WFKF4-P/12/S3550	8045188
		4+PE	A	60V	4 A	•	1,0...2,5	合金, 铜锌, 镀镍		EC-WFKF5-P/12/S3525	8050273
							2,5...4,0	合金, 铜锌, 镀镍		EC-WFKF5-P/12/S3540	8050272
							4,0...5,0	合金, 铜锌, 镀镍		EC-WFKF5-P/12/S3550	8050257
	传感器执行器 公头, 弯型, M12 后面板安装 (带固定螺丝) PC板-连接	4	A	250V	4 A	•	1,0...5,0	合金, 铜锌, 镀镍		EC-WFSF4-P/12	8046571
		4+PE		60V	4 A	•		合金, 不锈钢		EC-WFSF5-P/12	8044960
	公头, M12 焊接连接	4	A	250V	4 A					EWAS4	8008155
		4+PE	A	60V	4 A					EWAS5	8017592
		5	A	60V	4 A					EWAS4.5	8008156
		8	A	30V	2 A					EWAS8	8009737
		12	A	30V	1.5 A					EWAS12	8030496
	食品饮料加工行业 母头, 直型, M12 前面板安装 (不带固定螺丝) 焊接连接	4	A	250V	4 A			V4A	PG9	FB-FKE4-L/PG9	8068276
		5	A	60V	4 A			V4A	PG9	FB-FKE4.5-L/PG9	8068277
	食品饮料加工行业 母头, 直型, M12 前面板安装 (不带固定螺丝) 线芯连接	4	A	250V	4 A	0.50		V4A	PG9	FB-FKE4-0,5/PG9	8068278
		5	A	60V	4 A	0.50		V4A	PG9	FB-FKE4.5-0,5/PG9	8068279
	食品饮料加工行业 公头, 直型, M12 前面板安装 (不带固定螺丝) 焊接连接	4	A	250V	4 A			V4A	PG9	FB-FSE4-L/PG9	8068272
		5	A	60V	4 A			V4A	PG9	FB-FSE4.5-L/PG9	8068273
	食品饮料加工行业 公头, 直型, M12 前面板安装 (不带固定螺丝) 线芯连接	4	A	250V	4 A	0.50		V4A	PG9	FB-FSE4-0,5/PG9	8068274
		5	A	60V	4 A	0.50		V4A	PG9	FB-FSE4.5-0,5/PG9	8068275
	高温 母头, 直型, M12 前面板安装 (不带固定螺丝) 线芯连接	3	A	250V	4 A	0.50		合金, 铜锌, 镀镍	M16x1.5	HT-FK3-0,5/16/S2470	8037311
		4	A	250V	4 A	0.50		合金, 铜锌, 镀镍	M16x1.5	HT-FK4-0,5/16/S2470	8037322
		5	A	60V	4 A	0.50		合金, 铜锌, 镀镍	M16x1.5	HT-FK4.5-0,5/16/S2470	8037323
	高温 公头, 直型, M12 前面板安装 (不带固定螺丝) 线芯连接	3	A	250V	4 A	0.50		合金, 铜锌, 镀镍	M16x1.5	HT-FS3-0,5/16/S2470	8037288
		4	A	250V	4 A	0.50		合金, 铜锌, 镀镍	M16x1.5	HT-FS4-0,5/16/S2470	8037292
		5	A	60V	4 A	0.50		合金, 铜锌, 镀镍	M16x1.5	HT-FS4.5-0,5/16/S2470	8037293
	工业以太网, rail approved 母头, 直型, M12 后面板安装 (带固定螺丝) 线芯连接	4	D	250V	4 A	•	0.50	合金, 铜锌, 镀镍	M16x1.5	IE-FHM12KUD4.029-0,5/M16	8072504

























		针脚	编码	最大电压	最大电流 UL	L [m]	Δh[mm]	插座外壳材料	锁紧螺纹	产品描述	物料编号
	工业以太网, rail approved 公头, 直型, M12 后面板安装 (带固定螺丝) 线芯连接	4	D	250V	4 A	•	0.50	合金, 铜锌, 镀镍	M16x1.5	IE-FHM12SUD4.029-0,5/M16	8072520
	工业以太网, rail approved 母头, 直型, M12 前面板安装 (不带固定螺丝) 线芯连接	4	D	250V	4 A	•	0.50	合金, 铜锌, 镀镍	M16x1.5	IE-FVM12KUD4.029-0,5/M16	8072505
	工业以太网, rail approved 母头, 直型, M12 前面板安装, 可定位的 线芯连接	4	D	250V	4 A	•	0.50	合金, 铜锌, 镀镍	M16x1.5	IE-FVM12KUD4.029-0,5/M16/S520	8077905
	工业以太网, rail approved 公头, 直型, M12 前面板安装 (不带固定螺丝) 线芯连接	4	D	250V	4 A	•	0.50	合金, 铜锌, 镀镍	M16x1.5	IE-FVM12SUD4.029-0,5/M16	8072521
	工业以太网, rail approved 公头, 直型, M12 前面板安装, 可定位的 线芯连接	4	D	250V	4 A	•	0.50	合金, 铜锌, 镀镍	M16x1.5	IE-FVM12SUD4.029-0,5/M16/S520	8077968
	工业以太网, rail approved 公头, 直型, M12 后面板安装 (带固定螺丝) PC板-连接	4	D	250V	4 A	•	1,0...5,0	合金, 铜锌, 镀镍	M16x1.5	IE-FHM12SUD4-P/M16	8072586
	工业以太网, rail approved 母头, 直型, M12 前面板安装 (带固定螺丝) PC板-连接 屏蔽	8	X	50V <sub>AC</sub>   60V <sub>DC</sub>	0.5 A	•	0,9...2,5	合金, 铜锌, 镀镍	M12x1	IE-FKDSX8-P/12	8050232
	工业以太网, rail approved 母头, 直型, M12 后面板安装 (带固定螺丝) PC板-连接	4	D	250V	4 A	•	1,0...5,0	合金, 铜锌, 镀镍	M16x1.5	IE-FHM12KUD4-P/M16	8072576
	工业以太网, rail approved 母头, 直型, M12 后面板安装 (带固定螺丝) PC板-连接 屏蔽	4	D	250V	4 A	•	1,0...2,5	合金, 铜锌, 镀镍	M12x1	IE-FHM12KUD4-P/M12/S3525	8074847
							2,5...4,0	合金, 铜锌, 镀镍	M12x1	IE-FHM12KUD4-P/M12/S3540	8074846
							4,0...5,0	合金, 铜锌, 镀镍	M12x1	IE-FHM12KUD4-P/M12/S3550	8072578
	母头, 直型, M12 后面板安装 (带固定螺丝) PC板-连接 屏蔽	8	X	50V <sub>AC</sub>   60V <sub>DC</sub>	0.5 A	•		合金, 铜锌, 镀镍		IE-FHM12KSX8P/PG9	8079981
	工业以太网 母头, 弯型, M12 后面板安装 (带固定螺丝) PC板-连接 屏蔽	4	D	250V	4 A	•	1,0...2,5	合金, 铜锌, 镀镍	M12x1	IE-WFKFSY4-P/12/S3525	8050282
							2,5...4,0	合金, 铜锌, 镀镍	M12x1	IE-WFKFSY4-P/12/S3540	8050284
							4,0...5,0	合金, 铜锌, 镀镍	M12x1	IE-WFKFSY4-P/12/S3550	8050285







		针脚	编码	最大电压	最大电流 UL	L [m]	Δh[mm]	插座外壳材料	锁紧螺纹	产品描述	物料编号
	工业以太网, rail approved 母头, 弯型, M12 后面板安装 (带固定螺丝) PC板-连接 屏蔽	8	X	50V <sub>AC</sub>   60V <sub>DC</sub>	0.5 A	•	1,0...2,5	合金, 铜锌, 镀镍		IE-WFKFSX8-P/12/S3525	8059345
							2,5...4,0	合金, 铜锌, 镀镍		IE-WFKFSX8-P/12/S3540	8059346
							4,0...5,0	合金, 铜锌, 镀镍		IE-WFKFSX8-P/12/S3550	8059347
	工业以太网 母头, 直型, M12 后面板安装 (带固定螺丝) PROFINET AWG22/7 Typ C 屏蔽	4	D	250V	4 A	2	5	合金, 铜锌, 镀镍	M16x1.5	IE-FKFDSY4.029-2/16/S2171	8063608
							5	合金, 铜锌, 镀镍	M16x1.5	IE-FKFDSY4.029-5/16/S2171	8063609
							10	合金, 铜锌, 镀镍	M16x1.5	IE-FKFDSY4.029-10/16/S2171	8063610
	工业以太网 母头, 直型, M12 后面板安装 (带固定螺丝) PROFINET robotic AWG22/19 Typ R, 屏蔽	4	D	250V	4 A	2	5	合金, 铜锌, 镀镍	M16x1.5	IE-FKFDSY4.029-2/16/S5100	8088147
							5	合金, 铜锌, 镀镍	M16x1.5	IE-FKFDSY4.029-5/16/S5100	8088148
							10	合金, 铜锌, 镀镍	M16x1.5	IE-FKFDSY4.029-10/16/S5100	8088149
	工业以太网 母头, 直型, M12 前面板安装 (不带固定螺丝) PROFINET AWG22/7 Typ C 屏蔽	4	D	250V	4 A	2	5	合金, 铜锌, 镀镍	M16x1.5	IE-FKSY4.029-2/16/S2171/S3941	8063614
							5	合金, 铜锌, 镀镍	M16x1.5	IE-FKSY4.029-5/16/S2171/S3941	8063615
							10	合金, 铜锌, 镀镍	M16x1.5	IE-FKSY4.029-10/16/S2171/S3941	8063616
	工业以太网 母头, 直型, M12 前面板安装 (不带固定螺丝) PROFINET robotic AWG22/19 Typ R, 屏蔽	4	D	250V	4 A	2	5	合金, 铜锌, 镀镍	M16x1.5	IE-FKSY4.029-2/16/S5100/S3941	8088984
							5	合金, 铜锌, 镀镍	M16x1.5	IE-FKSY4.029-5/16/S5100/S3941	8088985
							10	合金, 铜锌, 镀镍	M16x1.5	IE-FKSY4.029-10/16/S5100/S3941	8089428
	工业以太网 母头, 直型, M12 后面板安装 (带固定螺丝) 屏蔽	4	D	250V	4 A	2	5	合金, 铜锌, 镀镍	M16x1.5	IE-FKFDSY4.082-2/16/S3400	8064034
							5	合金, 铜锌, 镀镍	M16x1.5	IE-FKFDSY4.082-5/16/S3400	8064035
							10	合金, 铜锌, 镀镍	M16x1.5	IE-FKFDSY4.082-10/16/S3400	8064036
	工业以太网 母头, 弯型, M12 后面板安装 (带固定螺丝) PROFINET AWG22/7 Typ C 屏蔽	4	D	250V	4 A	2	5	合金, 铜锌, 镀镍	M16x1.5	IE-WFKFDSY4.029-2/16/S2171	8063611
							5	合金, 铜锌, 镀镍	M16x1.5	IE-WFKFDSY4.029-5/16/S2171	8063612
							10	合金, 铜锌, 镀镍	M16x1.5	IE-WFKFDSY4.029-10/16/S2171	8063613
	工业以太网 母头, 弯型, M12 后面板安装 (带固定螺丝) PROFINET robotic AWG22/19 Typ R, 屏蔽	4	D	250V	4 A	2	5	合金, 铜锌, 镀镍	M16x1.5	IE-WFKFDSY4.029-2/16/S5100	8088150
							5	合金, 铜锌, 镀镍	M16x1.5	IE-WFKFDSY4.029-5/16/S5100	8088151
							10	合金, 铜锌, 镀镍	M16x1.5	IE-WFKFDSY4.029-10/16/S5100	8088152
	工业以太网 母头, 直型, M12 前面板安装 (不带固定螺丝) Sercos 屏蔽	4	D	250V	4 A	2	5	合金, 铜锌, 镀镍	M16x1.5	IE-FKSY4.029-2/16/S3800/S3801	8063605
							5	合金, 铜锌, 镀镍	M16x1.5	IE-FKSY4.029-5/16/S3800/S3801	8063606
							10	合金, 铜锌, 镀镍	M16x1.5	IE-FKSY4.029-10/16/S3800/S3801	8063607
	工业以太网 母头, 直型, M12 后面板安装 (带固定螺丝) PC板-连接	4	D	250V	4 A	•		合金, 铜锌, 镀镍	M16x1.5	IE-FKFDY4-P/16/S38	8055849













		针脚	编码	最大电压	最大电流 UL	L [m]	Δh[mm]	插座外壳材料	锁紧螺纹	产品描述	物料编号
	工业以太网 母头, 弯型, M12 后面板安装 (带固定螺丝) PC板-连接 屏蔽	4	D	250V	4 A		1,0...2,5	合金, 铜锌, 镀镍		IE-WFKFSY4-P/12/S3825	8055850
							2,5...4,0	合金, 铜锌, 镀镍		IE-WFKFSY4-P/12/S3840	8055851
							4,0...5,0	合金, 铜锌, 镀镍		IE-WFKFSY4-P/12/S3850	8055852
	工业以太网 母头, 直型, M12 后面板安装 (带固定螺丝) Sercos 屏蔽	4	D	250V	4 A	2		合金, 铜锌, 镀镍	M16x1.5	IE-FKFDSY4.029-5/16/S3800/S38	8063600
								合金, 铜锌, 镀镍	M16x1.5	IE-FKFDSY4.029-2/16/S3800/S38	8063599
								合金, 铜锌, 镀镍	M16x1.5	IE-FKFDSY4.029-10/16/S3800/S38	8063601
	工业以太网 母头, 弯型, M12 后面板安装 (带固定螺丝) Sercos 屏蔽	4	D	250V	4 A	2		合金, 铜锌, 镀镍	M16x1.5	IE-WFKFDSY4.029-5/16/S3800/S38	8063603
								合金, 铜锌, 镀镍	M16x1.5	IE-WFKFDSY4.029-2/16/S3800/S38	8063602
								合金, 铜锌, 镀镍	M16x1.5	IE-WFKFDSY4.029-10/16/S3800/S38	8063604
	Profibus 母头, 弯型, M12 后面板安装 (带固定螺丝) PC板-连接 屏蔽	5	B	60V	4 A		1,0...2,5	合金, 铜锌, 镀镍	M12x1	PB-WFKFSW5-P/12/S3525	8050279
							2,5...4,0	合金, 铜锌, 镀镍	M12x1	PB-WFKFSW5-P/12/S3540	8050280
							4,0...5,0	合金, 铜锌, 镀镍	M12x1	PB-WFKFSW5-P/12/S3550	8050281
	Profibus 母头, 直型, M12 后面板安装 (带固定螺丝) 线芯连接	5	B	60V	4 A	0.50		合金, 铜锌, 镀镍	M16x1.5	PB-FHM12KUB2.012-0,5/M16	8072599
	Profibus 母头, 直型, M12 后面板安装 (带固定螺丝) PC板-连接	5	B	60V	4 A			合金, 铜锌, 镀镍	M16x1.5	PB-FHM12KUB5-P/M16	8072611
	Profibus 公头, 直型, M12 后面板安装 (带固定螺丝) 线芯连接	5	B	60V	4 A	0.50		合金, 铜锌, 镀镍	M16x1.5	PB-FHM12SUB2.012-0,5/M16	8072633
	Profibus 母头, 直型, M12 前面板安装 (不带固定螺丝) 线芯连接	5	B	60V	4 A	0.50		合金, 铜锌, 镀镍	M16x1.5	PB-FVM12KUB2.012-0,5/M16	8072602
	Profibus 母头, 直型, M12 前面板安装, 可定位的 线芯连接	5	B	60V	4 A	0.50		合金, 铜锌, 镀镍	M16x1.5	PB-FVM12KUB2.012-0,5/M16/S520	8077910
	Profibus 公头, 直型, M12 前面板安装 (不带固定螺丝) 线芯连接	5	B	60V	4 A	0.50		合金, 铜锌, 镀镍	M16x1.5	PB-FVM12SUB2.012-0,5/M16	8072634
	Profibus 公头, 直型, M12 前面板安装, 可定位的 线芯连接	5	B	60V	4 A	0.50		合金, 铜锌, 镀镍	M16x1.5	PB-FVM12SUB2.012-0,5/M16/S520	8077971

		针脚	编码	最大电压	最大电流 UL	L [m]	Δh[mm]	插座外壳材料	锁紧螺纹	产品描述	物料编号	
	Profibus 公头, 直型, M12 后面板安装 (带固定螺丝) PC板-连接	5	B	60V	4 A	•		合金, 铜锌, 镀镍	M16x1.5	PB-FHM12SUB4.5-P/M16	8072718	
	Profibus 公头, 弯型, M12 后面板安装 (带固定螺丝) PC板-连接 屏蔽	5	B	60V	4 A			合金, 铜锌, 镀镍	M12x1	PB-WFSFSW5-P/12	8045658	
	Profibus 母头, 直型, M12 后面板安装 (带固定螺丝) PROFIBUS 屏蔽	5	B	60V	4 A	•	2	合金, 铜锌, 镀镍	M16x1.5	PB-FKFDSW2.012-5/16/S1800	8063617	
							5	合金, 铜锌, 镀镍	M16x1.5	PB-FKFDSW2.012-2/16/S1800	8061882	
							10	合金, 铜锌, 镀镍	M16x1.5	PB-FKFDSW2.012-10/16/S1800	8063618	
	Profibus 母头, 弯型, M12 后面板安装 (带固定螺丝) PROFIBUS 屏蔽	5	B	60V	4 A	•	2	合金, 铜锌, 镀镍	M16x1.5	PB-WFKFDSW2.012-5/16/S1800	8063619	
							5	合金, 铜锌, 镀镍	M16x1.5	PB-WFKFDSW2.012-2/16/S1800	8061881	
							10	合金, 铜锌, 镀镍	M16x1.5	PB-WFKFDSW2.012-10/16/S1800	8063620	
	Profibus 母头, 直型, M12 前面板安装 (不带固定螺丝) PROFIBUS 屏蔽	5	B	60V	4 A	•	2	合金, 铜锌, 镀镍	M16x1.5	PB-FKSW2.012-5/16/S1800/S3941	8063622	
							5	合金, 铜锌, 镀镍	M16x1.5	PB-FKSW2.012-2/16/S1800/S3941	8063621	
							10	合金, 铜锌, 镀镍	M16x1.5	PB-FKSW2.012-10/16/S1800/S3941	8063623	
	CANopen/DeviceNet 母头, 直型, M12 前面板安装 (不带固定螺丝) 线芯连接	5	A	60V	4 A	•	0.50	合金, 铜锌, 镀镍	M16x1.5	CD-FVM12KUA5.022-0,5/M16	8085770	
	CANopen/DeviceNet 公头, 直型, M12 前面板安装 (不带固定螺丝) 线芯连接	5	A	60V	4 A	•	0.50	合金, 铜锌, 镀镍	M16x1.5	CD-FVM12SUA5.022-0,5/M16	8085772	
	CANopen/DeviceNet 母头, 直型, M12 后面板安装 (带固定螺丝) 线芯连接	5	A	60V	4 A	•	0.50	合金, 铜锌, 镀镍	M16x1.5	CD-FHM12KUA5.022-0,5/M16	8085771	
	CANopen/DeviceNet 公头, 直型, M12 后面板安装 (带固定螺丝) 线芯连接	5	A	60V	4 A	•	0.50	合金, 铜锌, 镀镍	M16x1.5	CD-FHM12SUA5.022-0,5/M16	8085773	
	POWER 母头, 直型, M12 前面板安装 (不带固定螺丝) 线芯连接	2+PE S		630V <sub>AC</sub>  600V <sub>AC(UL)</sub>	12 A	•	0.20	2.5	合金, 铜锌, 镀镍	M16x1.5	PS-FVM12KU3.002-0,2/M16/S5025	8086643
								1.5	合金, 铜锌, 镀镍	M16x1.5	PS-FVM12KU3.002-0,2/M16/S5015	8087076
		3+PE S		630V <sub>AC</sub>  600V <sub>AC(UL)</sub>	12 A	•	0.20	2.5	合金, 铜锌, 镀镍	M16x1.5	PS-FVM12KU4.155-0,2/M16/S5025	8086188
								1.5	合金, 铜锌, 镀镍	M16x1.5	PS-FVM12KU4.155-0,2/M16/S5015	8087080









	针脚	编码	最大电压	最大电流 UL	L [m]	Δh[mm]	插座外壳材料	锁紧螺纹	产品描述	物料编号
	2+PE S	POWER 公头, 直型, M12 前面板安装 (不带固定螺丝) 线芯连接	630V <sub>AC</sub>  600V <sub>AC(UL)</sub>	12 A	• 0.20	2.5	合金, 铜锌, 镀镍	M16x1.5	PS-FVM12SU3.002-0,2/M16/S5025	8086644
						1.5	合金, 铜锌, 镀镍	M16x1.5	PS-FVM12SU3.002-0,2/M16/S5015	8087077
	3+PE S	630V <sub>AC</sub>  600V <sub>AC(UL)</sub>	12 A	• 0.20	2.5	合金, 铜锌, 镀镍	M16x1.5	PS-FVM12SU4.155-0,2/M16/S5025	8086189	
					1.5	合金, 铜锌, 镀镍	M16x1.5	PS-FVM12SU4.155-0,2/M16/S5015	8087081	
	2+PE S	POWER 母头, 直型, M12 后面板安装 (带固定螺丝) 线芯连接	630V <sub>AC</sub>  600V <sub>AC(UL)</sub>	12 A	• 0.20	2.5	合金, 铜锌, 镀镍	M16x1.5	PS-FHM12KU3.002-0,2/M16/S5025	8086182
						1.5	合金, 铜锌, 镀镍	M16x1.5	PS-FHM12KU3.002-0,2/M16/S5015	8087074
	3+PE S	630V <sub>AC</sub>  600V <sub>AC(UL)</sub>	12 A	• 0.20	2.5	合金, 铜锌, 镀镍	M16x1.5	PS-FHM12KU4.155-0,2/M16/S5025	8086184	
					1.5	合金, 铜锌, 镀镍	M16x1.5	PS-FHM12KU4.155-0,2/M16/S5015	8087078	
	2+PE S	POWER 公头, 直型, M12 后面板安装 (带固定螺丝) 线芯连接	630V <sub>AC</sub>  600V <sub>AC(UL)</sub>	12 A	• 0.20	2.5	合金, 铜锌, 镀镍	M16x1.5	PS-FHM12SU3.002-0,2/M16/S5025	8086183
						1.5	合金, 铜锌, 镀镍	M16x1.5	PS-FHM12SU3.002-0,2/M16/S5015	8087075
	3+PE S	630V <sub>AC</sub>  600V <sub>AC(UL)</sub>	12 A	• 0.20	2.5	合金, 铜锌, 镀镍	M16x1.5	PS-FHM12SU4.155-0,2/M16/S5025	8086185	
					1.5	合金, 铜锌, 镀镍	M16x1.5	PS-FHM12SU4.155-0,2/M16/S5015	8087079	
	2+PE S	POWER 母头, 直型, M12 后面板安装 (带固定螺丝) PC板-连接	630V <sub>AC</sub>  600V <sub>AC(UL)</sub>	12 A	•		合金, 铜锌, 镀镍	M16x1.5	PS-FHM12KU3-P/M16	8086641
	3+PE S	630V <sub>AC</sub>  600V <sub>AC(UL)</sub>	12 A	•		合金, 铜锌, 镀镍	M16x1.5	PS-FHM12KU4-P/M16	8086186	
	2+PE S	POWER 母头, 直型, M12 后面板安装 (带固定螺丝) PC板-连接	630V <sub>AC</sub>  600V <sub>AC(UL)</sub>	12 A	•		合金, 铜锌, 镀镍	M16x1.5	PS-FHM12SU3-P/M16	8086642
	3+PE S	630V <sub>AC</sub>  600V <sub>AC(UL)</sub>	12 A	•		合金, 铜锌, 镀镍	M16x1.5	PS-FHM12SU4-P/M16	8086187	
	4 T	POWER 母头, 直型, M12 前面板安装 (不带固定螺丝) 线芯连接	63V <sub>DC</sub>	12 A	• 0.20	2.5	合金, 铜锌, 镀镍	M16x1.5	PT-FVM12KU4-0,2/M16/S5025	8086194
						1.5	合金, 铜锌, 镀镍	M16x1.5	PT-FVM12KU4-0,2/M16/S5015	8087084
	4 T	POWER 公头, 直型, M12 前面板安装 (不带固定螺丝) 线芯连接	63V <sub>DC</sub>	12 A	• 0.20	2.5	合金, 铜锌, 镀镍	M16x1.5	PT-FVM12SU4-0,2/M16/S5025	8086195
						1.5	合金, 铜锌, 镀镍	M16x1.5	PT-FVM12SU4-0,2/M16/S5015	8087085
	4 T	POWER 母头, 直型, M12 后面板安装 (带固定螺丝) 线芯连接	63V <sub>DC</sub>	12 A	• 0.20	2.5	合金, 铜锌, 镀镍	M16x1.5	PT-FHM12KU4-0,2/M16/S5025	8086190
						1.5	合金, 铜锌, 镀镍	M16x1.5	PT-FHM12KU4-0,2/M16/S5015	8087082
	4 T	POWER 公头, 直型, M12 后面板安装 (带固定螺丝) 线芯连接	63V <sub>DC</sub>	12 A	• 0.20	2.5	合金, 铜锌, 镀镍	M16x1.5	PT-FHM12SU4-0,2/M16/S5025	8086191
						1.5	合金, 铜锌, 镀镍	M16x1.5	PT-FHM12SU4-0,2/M16/S5015	8087083
	4 T	POWER 母头, 直型, M12 后面板安装 (带固定螺丝) PC板-连接	63V <sub>DC</sub>	12 A	•		合金, 铜锌, 镀镍	M16x1.5	PT-FHM12KU4-P/M16	8086192
	4 T	POWER 公头, 直型, M12 后面板安装 (带固定螺丝) PC板-连接	63V <sub>DC</sub>	12 A	•		合金, 铜锌, 镀镍	M16x1.5	PT-FHM12SU4-P/M16	8086193

	针脚	编码	最大电压	最大电流 UL	L [m]	Δh[mm]	插座外壳材料	锁紧螺纹	产品描述	物料编号
	4	L	63V <sub>dc</sub>	12 A	• 0.20	2.5	合金, 铜锌, 镀镍	M16x1.5	PL-FVM12KU4-0,2/M16/S5025	8086638
						1.5	合金, 铜锌, 镀镍	M16x1.5	PL-FVM12KU4-0,2/M16/S5015	8087068
	4+FE	L	63V <sub>dc</sub>	16 A	• 0.20	2.5	合金, 铜锌, 镀镍	M16x1.5	PL-FVM12KU5.269-0,2/M16/S5025	8086180
						1.5	合金, 铜锌, 镀镍	M16x1.5	PL-FVM12KU5.269-0,2/M16/S5015	8087073
	4	L	63V <sub>dc</sub>	12 A	• 0.20	2.5	合金, 铜锌, 镀镍	M16x1.5	PL-FVM12SU4-0,2/M16/S5025	8086639
						1.5	合金, 铜锌, 镀镍	M16x1.5	PL-FVM12SU4-0,2/M16/S5015	8087069
	4+FE	L	63V <sub>dc</sub>	16 A	• 0.20	2.5	合金, 铜锌, 镀镍	M16x1.5	PL-FVM12SU5.269-0,2/M16/S5025	8086181
						1.5	合金, 铜锌, 镀镍	M16x1.5	PL-FVM12SU5.269-0,2/M16/S5015	8087072
	4	L	63V <sub>dc</sub>	12 A	• 0.20	2.5	合金, 铜锌, 镀镍	M16x1.5	PL-FHM12KU4-0,2/M16/S5025	8086175
						1.5	合金, 铜锌, 镀镍	M16x1.5	PL-FHM12KU4-0,2/M16/S5015	8087066
	4+FE	L	63V <sub>dc</sub>	16 A	• 0.20	2.5	合金, 铜锌, 镀镍	M16x1.5	PL-FHM12KU5.269-0,2/M16/S5025	8086177
						1.5	合金, 铜锌, 镀镍	M16x1.5	PL-FHM12KU5.269-0,2/M16/S5015	8087070
	4	L	63V <sub>dc</sub>	12 A	• 0.20	2.5	合金, 铜锌, 镀镍	M16x1.5	PL-FHM12SU4-0,2/M16/S5025	8086176
						1.5	合金, 铜锌, 镀镍	M16x1.5	PL-FHM12SU4-0,2/M16/S5015	8087067
	4+FE	L	63V <sub>dc</sub>	16 A	• 0.20	2.5	合金, 铜锌, 镀镍	M16x1.5	PL-FHM12SU5.269-0,2/M16/S5025	8086178
						1.5	合金, 铜锌, 镀镍	M16x1.5	PL-FHM12SU5.269-0,2/M16/S5015	8087071
	4	L	63V <sub>dc</sub>	16 A	•		合金, 铜锌, 镀镍	M16x1.5	PL-FHM12KU4-P/M16	8086636
	4+FE	L	63V <sub>dc</sub>	16 A	•		合金, 铜锌, 镀镍	M16x1.5	PL-FHM12KU5-P/M16	8086640
	4	L	63V <sub>dc</sub>	16 A	•		合金, 铜锌, 镀镍	M16x1.5	PL-FHM12SU4-P/M16	8086637
	4+FE	L	63V <sub>dc</sub>	16 A	•		合金, 铜锌, 镀镍	M16x1.5	PL-FHM12SU5-P/M16	8086179
	4+PE	K	630V <sub>AC</sub>  600V <sub>AC(UL)</sub>	12 A	• 0.20	2.5	合金, 铜锌, 镀镍	M16x1.5	PK-FVM12KU5.244-0,2/M16/S5025	8086173
						1.5	合金, 铜锌, 镀镍	M16x1.5	PK-FVM12KU5.244-0,2/M16/S5015	8087065
	4+PE	K	630V <sub>AC</sub>  600V <sub>AC(UL)</sub>	12 A	• 0.20	2.5	合金, 铜锌, 镀镍	M16x1.5	PK-FVM12SU5.244-0,2/M16/S5025	8086174
						1.5	合金, 铜锌, 镀镍	M16x1.5	PK-FVM12SU5.244-0,2/M16/S5015	8087064
	4+PE	K	630V <sub>AC</sub>  600V <sub>AC(UL)</sub>	12 A	• 0.20	2.5	合金, 铜锌, 镀镍	M16x1.5	PK-FHM12KU5.244-0,2/M16/S5025	8086169
						1.5	合金, 铜锌, 镀镍	M16x1.5	PK-FHM12KU5.244-0,2/M16/S5015	8087062
	4+PE	K	630V <sub>AC</sub>  600V <sub>AC(UL)</sub>	12 A	• 0.20	2.5	合金, 铜锌, 镀镍	M16x1.5	PK-FHM12SU5.244-0,2/M16/S5025	8086170
						1.5	合金, 铜锌, 镀镍	M16x1.5	PK-FHM12SU5.244-0,2/M16/S5015	8087063
	4+PE	K	630V <sub>AC</sub>  600V <sub>AC(UL)</sub>	12 A	•		合金, 铜锌, 镀镍	M16x1.5	PK-FHM12KU5-P/M16	8086171

	针脚	编码	最大电压	最大电流 UL	L [m]	Δh[mm]	插座外壳材料	锁紧螺纹	产品描述	物料编号
 POWER 公头, 直型, M12 后面板安装 (带固定螺丝) PC板-连接	4+PE	K	630V <sub>AC</sub>  600V <sub>AC(UL)</sub>	12 A	•		合金, 铜锌, 镀镍	M16x1.5	PK-FHM12SU5-P/M16	8086172
 传感器执行器 母头, 直型, M8 前面板安装 (带固定螺丝) 线芯连接	3	A	60V	4 A	•	0.20 2,0...5,0	合金, 铜锌, 镀镍	M8x0, 5	AL-FVM8KUA3-0,2/M8	8071345
							不锈钢 1.4404	M8x0, 5	AL-FVM8EKUA3-0,2/M8	8084376
	4	A	60V	4 A	•	0.20 2,0...5,0	合金, 铜锌, 镀镍	M8x0, 5	AL-FVM8KUA4-0,2/M8	8071346
							不锈钢 1.4404	M8x0, 5	AL-FVM8EKUA4-0,2/M8	8084377
	5	B	30V	3 A	•	0.20 2,0...5,0	合金, 铜锌, 镀镍	M8x0, 5	AL-FVM8KUB4.5-0,2/M8	8071347
							不锈钢 1.4404	M8x0, 5	AL-FVM8EKUB4.5-0,2/M8	8084378
 传感器执行器 公头, 直型, M8 前面板安装 (带固定螺丝) 线芯连接	3	A	60V	4 A	•	0.20 2,0...5,0	合金, 铜锌, 镀镍	M8x0, 5	AL-FVM8SUA3-0,2/M8	8071417
							不锈钢 1.4404	M8x0, 5	AL-FVM8ESUA3-0,2/M8	8084382
	4	A	60V	4 A	•	0.20 2,0...5,0	合金, 铜锌, 镀镍	M8x0, 5	AL-FVM8SUA4-0,2/M8	8071419
							不锈钢 1.4404	M8x0, 5	AL-FVM8ESUA4-0,2/M8	8084383
	5	B	30V	3 A	•	0.20 2,0...5,0	合金, 铜锌, 镀镍	M8x0, 5	AL-FVM8SUB4.5-0,2/M8	8071420
							不锈钢 1.4404	M8x0, 5	AL-FVM8ESUB4.5-0,2/M8	8084384
 传感器执行器 母头, 直型, M8 后面板安装 (带固定螺丝) 线芯连接	3	A	60V	4 A	•	0.20 3,0...6,0	合金, 铜锌, 镀镍	M10x1	AL-FHM8KUA3-0,2/M10	8071402
							不锈钢 1.4404	M10x1	AL-FHM8EKUA3-0,2/M10	8084379
	4	A	60V	4 A	•	0.20 3,0...6,0	合金, 铜锌, 镀镍	M10x1	AL-FHM8KUA4-0,2/M10	8071405
							不锈钢 1.4404	M10x1	AL-FHM8EKUA4-0,2/M10	8084380
	5	B	30V	3 A	•	0.20 3,0...6,0	合金, 铜锌, 镀镍	M10x1	AL-FHM8KUB4.5-0,2/M10	8071406
							不锈钢 1.4404	M10x1	AL-FHM8EKUB4.5-0,2/M10	8084381
 传感器执行器 公头, 直型, M8 后面板安装 (带固定螺丝) 线芯连接	3	A	60V	4 A	•	0.20 2,0...4,5	合金, 铜锌, 镀镍	M8x1	AL-FHM8SUA3-0,2/M8	8071421
							不锈钢 1.4404	M8x1	AL-FHM8ESUA3-0,2/M8	8084385
	4	A	60V	4 A	•	0.20 2,0...4,5	合金, 铜锌, 镀镍	M8x1	AL-FHM8SUA4-0,2/M8	8071422
							不锈钢 1.4404	M8x1	AL-FHM8ESUA4-0,2/M8	8084386
	5	B	30V	3 A	•	0.20 2,0...4,5	合金, 铜锌, 镀镍	M8x1	AL-FHM8SUB4.5-0,2/M8	8071423
							不锈钢 1.4404	M8x1	AL-FHM8ESUB4.5-0,2/M8	8084387
 传感器执行器 母头, 直型, M8 后面板安装 (带固定螺丝) PC板-连接	3	A	60V	4 A	•	3,0...6,0	合金, 铜锌, 镀镍	M10x1	AL-FHM8KUA3-P/M10	8073385
							不锈钢 1.4404	M10x1	AL-FHM8EKUA3-P/M10	8084388
	4	A	60V	4 A	•	3,0...6,0	合金, 铜锌, 镀镍	M10x1	AL-FHM8KUA4-P/M10	8073386
							不锈钢 1.4404	M10x1	AL-FHM8EKUA4-P/M10	8084389
	5	B	30V	3 A	•	3,0...6,0	合金, 铜锌, 镀镍	M10x1	AL-FHM8KUB4.5-P/M10	8073387
							不锈钢 1.4404	M10x1	AL-FHM8EKUB4.5-P/M10	8084390

		针脚	编码	最大电压	最大电流 UL	L [m]	Δh[mm]	插座外壳材料	锁紧螺纹	产品描述	物料编号
	传感器执行器 公头, 直型, M8 后面板安装 (带固定螺丝) PC板-连接	3	A	60V	4 A	•	2,0...4,5	合金, 铜锌, 镀镍	M8x1	AL-FHM8SUA3-P/M8	8073397
								不锈钢 1.4404	M8x1	AL-FHM8ESUA3-P/M8	8084391
		4	A	60V	4 A	•	2,0...4,5	合金, 铜锌, 镀镍	M8x1	AL-FHM8SUA4-P/M8	8073398
								不锈钢 1.4404	M8x1	AL-FHM8ESUA4-P/M8	8084392
		5	B	30V	3 A	•	2,0...4,5	合金, 铜锌, 镀镍	M8x1	AL-FHM8SUB4.5-P/M8	8073399
								不锈钢 1.4404	M8x1	AL-FHM8ESUB4.5-P/M8	8084393
	传感器执行器 母头, 直型, M8 后面板安装 (带固定螺丝) PC板-连接 屏蔽	3	A	60V	4 A	•		合金, 铜锌, 镀镍	M10x1	AL-FHM8KSA3-P/M10	8073389
		4	A	60V	4 A	•		合金, 铜锌, 镀镍	M10x1	AL-FHM8KSA4-P/M10	8073390
		5	B	30V	3 A	•		合金, 铜锌, 镀镍	M10x1	AL-FHM8KSB4.5-P/M10	8073391
	传感器执行器 公头, 直型, M8 后面板安装 (带固定螺丝) PC板-连接 屏蔽	3	A	60V	4 A	•		合金, 铜锌, 镀镍	M8x1	AL-FHM8SSA3-P/M8	8073400
		4	A	60V	4 A	•		合金, 铜锌, 镀镍	M8x1	AL-FHM8SSA4-P/M8	8073401
		5	B	30V	3 A	•		合金, 铜锌, 镀镍	M8x1	AL-FHM8SSB4.5-P/M8	8073402
	传感器执行器 母头, 弯型, M8 后面板安装 (带固定螺丝) PC板-连接 屏蔽	3	A	60V	4 A	•		合金, 铜锌, 镀镍	M10x1	AL-WFHM8KSA3-P/M10	8088510
		4	A	60V	4 A	•		合金, 铜锌, 镀镍	M10x1	AL-WFHM8KSA4-P/M10	8088511
		5	B	30V	3 A	•		合金, 铜锌, 镀镍	M10x1	AL-WFHM8KSB4.5-P/M10	8088512
	传感器执行器 公头, 弯型, M8 后面板安装 (带固定螺丝) PC板-连接 屏蔽	3	A	60V	4 A	•		合金, 铜锌, 镀镍	M8x1	AL-WFHM8SSA3-P/M8	8088515
		4	A	60V	4 A	•		合金, 铜锌, 镀镍	M8x1	AL-WFHM8SSA4-P/M8	8088516
		5	B	30V	3 A	•		合金, 铜锌, 镀镍	M8x1	AL-WFHM8SSB4.5-P/M8	8088517
	公头, M8/Ø8mm 快插 焊接连接	3		60V	4 A					SESP3SL	8008157
		4		60V	4 A					SESP4SL	8037479
	母头, Ø8mm快插 PC板-连接	3		60V	4 A					EKP3SP	8009728
		4		60V	4 A					EKP4SP	8009729
		5		30V	3 A					EKP4.5SP	8043797
	公头, Ø8mm快插 PC板-连接	4		60V	4 A					ESP4SP	8036657
		5		30V	3 A					ESP5SP	8089243
	公头, Ø8mm快插 焊接连接	3		60V	4 A					ESP3SL	8008163
		4		60V	4 A					ESP4S	8008164
		5		30V	3 A					ESP5SL	8089106
	公头, Ø8mm快插 PC板-连接	3		60V	4 A					ESHP3P	8008159
		4		60V	4 A					ESHP4P	8008160
	公头, Ø8mm快插 焊接连接	3		60V	4 A					ESHP3L	8008161
		4		60V	4 A					ESHP4L	8008162
	公头, M8/Ø8mm 快插 PC板-连接	3		60V	4 A					ESGP3P	8008742
		4		60V	4 A					ESGP4P	8008743



		针脚	编码	最大电压	最大电流 UL	L [m]	Δh[mm]	插座外壳材料	锁紧螺纹	产品描述	物料编号
	公头, M8/Ø8mm 快插 焊接连接	3		60V	4 A					ESGP3L	8008744
		4		60V	4 A					ESGP4L	8008745
	工业以太网 母头, 直型, M8 后面板安装 (带固定螺丝) PC板-连接 屏蔽	4	D	50V <sub>AC</sub>   60V <sub>DC</sub>	4 A			合金, 铜锌, 镀镍	M10x1	IE-FHM8KSD4-P/M10	8089337
	工业以太网 公头, 直型, M8 后面板安装 (带固定螺丝) PC板-连接 屏蔽	4	D	50V <sub>AC</sub>   60V <sub>DC</sub>	4 A			合金, 铜锌, 镀镍	M8x1	IE-FHM8SSD4-P/M8	8089338
	工业以太网 母头, 弯型, M8 后面板安装 (带固定螺丝) PC板-连接 屏蔽	4	D	50V <sub>AC</sub>   60V <sub>DC</sub>	4 A			合金, 铜锌, 镀镍	M10x1	IE-WFHM8KSD4-P/M10	8089339
	工业以太网 公头, 弯型, M8 后面板安装 (带固定螺丝) PC板-连接 屏蔽	4	D	50V <sub>AC</sub>   60V <sub>DC</sub>	4 A			合金, 铜锌, 镀镍	M8x1	IE-WFHM8SSD4-P/M8	8089340
	工业以太网 母头, 直型, M8 后面板安装 (带固定螺丝) PC板-连接 屏蔽	4	P	50V <sub>AC</sub>   60V <sub>DC</sub>	4 A			合金, 铜锌, 镀镍	M10x1	IE-FHM8KSP4-P/M10	8089341
	工业以太网 公头, 直型, M8 后面板安装 (带固定螺丝) PC板-连接 屏蔽	4	P	50V <sub>AC</sub>   60V <sub>DC</sub>	4 A			合金, 铜锌, 镀镍	M8x1	IE-FHM8SSP4-P/M8	8089342
	工业以太网 母头, 弯型, M8 后面板安装 (带固定螺丝) PC板-连接 屏蔽	4	P	50V <sub>AC</sub>   60V <sub>DC</sub>	4 A			合金, 铜锌, 镀镍	M10x1	IE-WFHM8KSP4-P/M10	8089343
	工业以太网 公头, 弯型, M8 后面板安装 (带固定螺丝) PC板-连接 屏蔽	4	P	50V <sub>AC</sub>   60V <sub>DC</sub>	4 A			合金, 铜锌, 镀镍	M8x1	IE-WFHM8SSP4-P/M8	8089344

命名

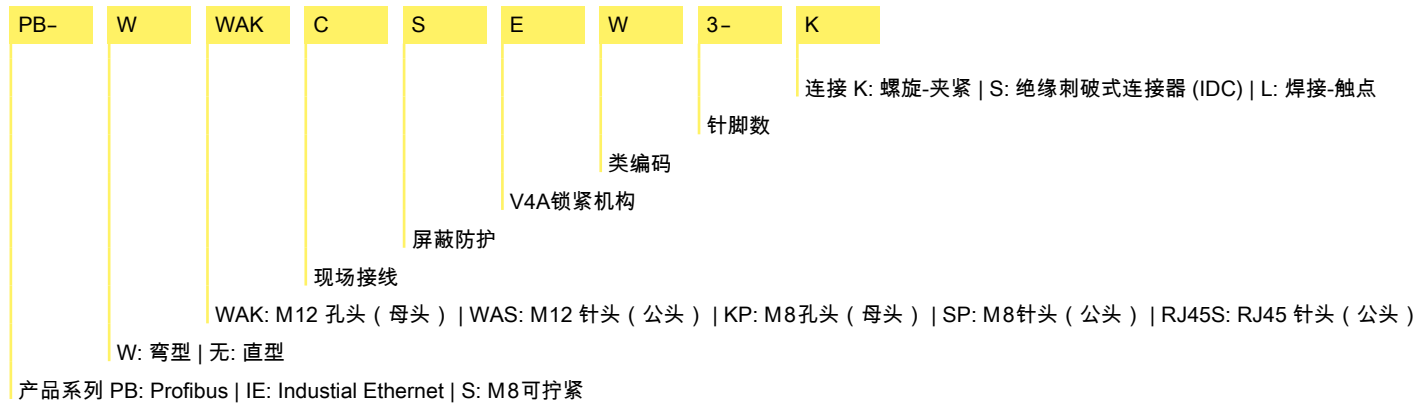











现场接线连接器

































## 现场接线连接器

技术参数	M12	M12 屏蔽	M8	M23	RJ45
绝缘电阻	$\geq 10^8 \Omega$	$\geq 10^8 \Omega$	$\geq 10^8 \Omega$	$\geq 10^8 \Omega$	$\geq 10^8 \Omega$
电阻	$\leq 5 m\Omega$	$\leq 5 m\Omega$	$\leq 5 m\Omega$	$\leq 5 m\Omega$	$\leq 5 m\Omega$
产品环境温度	-40°C...+85°C	-40°C...+85°C	-40°C...+85°C	-40°C...+125°C	-40°C...+70°C
触点材料	合金, 镀金	合金, 镀金	合金, 镀金	合金, 镀金	合金, 镀金
触头载体材料	塑料, PA	塑料, PA	塑料, PA	塑料, PBT	塑料, PA
夹紧基体材料	塑料	锌压铸, 镀镍	塑料	塑料	塑料
连接螺母材料	合金, 镀镍	合金, 镀镍	合金, 镀镍	合金, 镀镍	
标准	IEC 61076-2-101	IEC 61076-2-101	IEC 61076-2-104		IEC 60603-7-5
防护等级 (安装好)	IP67	IP67	IP67		IP20
机械寿命周期	>100 插拔次数	>100 插拔次数	>100 插拔次数	>100 插拔次数	>750 插拔次数
污染等级	3	3 (8X: 2)	3	3	1

		顶端						
		针脚	最大电压	最大电流	电缆出口	连接横截面积	产品描述	物料编号
	现场接线连接器 母头, 直型, M12 螺丝夹紧连接	4, A	250V	4A	4...6 mm	max. 0,75 mm <sup>2</sup>	WAKC4K	8004811
		5, A	125V	4A	4...6 mm	max. 0,75 mm <sup>2</sup>	WAKC5K	8004815
		8, A	60V	2A	6...8 mm	max. 0,5 mm <sup>2</sup>	WAKC8K	8021862
	现场接线连接器 母头, 直型, M12 螺丝夹紧连接 不锈钢	5, A	125V	4A	4...6 mm	max. 0,75 mm <sup>2</sup>	WAKCE5K	8063393
	现场接线连接器 母头, 弯型, M12 螺丝夹紧连接	4, A	250V	4A	4...6 mm	max. 0,75 mm <sup>2</sup>	WWAKC4K	8004808
		5, A	125V	4A	4...6 mm	max. 0,75 mm <sup>2</sup>	WWAKC5K	8004809
		8, A	30V	2A	6...8 mm	max. 0,25 mm <sup>2</sup>	WWAKC8K	8041146
	现场接线连接器 母头, 弯型, M12 螺丝夹紧连接 不锈钢	5, A	125V	4A	4...6 mm	max. 0,75 mm <sup>2</sup>	WWAKCE5K	8063395
	现场接线连接器 公头, 直型, M12 螺丝夹紧连接	4, A	250V	4A	4...6 mm	max. 0,75 mm <sup>2</sup>	WASC4K	8004804
		5, A	125V	4A	4...6 mm	max. 0,75 mm <sup>2</sup>	WASC5K	8004805
		8, A	60V	2A	6...8 mm	max. 0,5 mm <sup>2</sup>	WASC8K	8021863
	现场接线连接器 公头, 直型, M12 螺丝夹紧连接 不锈钢	5, A	125V	4A	4...6 mm	max. 0,75 mm <sup>2</sup>	WASCE5K	8063394
	现场接线连接器 公头, 弯型, M12 螺丝夹紧连接	4, A	250V	4A	4...6 mm	max. 0,75 mm <sup>2</sup>	WWASC4K	8004806
		5, A	125V	4A	4...6 mm	max. 0,75 mm <sup>2</sup>	WWASC5K	8004807
		8, A	30V	2A	6...8 mm	max. 0,75 mm <sup>2</sup>	WWASC8K	8052219
	现场接线连接器 公头, 弯型, M12 螺丝夹紧连接 不锈钢	5, A	125V	4A	4...6 mm	max. 0,75 mm <sup>2</sup>	WWASCE5K	8063396
	现场接线连接器 母头, 直型, M12 绝缘层剥离连接	3, A	32V	4A	2,9...5,1 mm	0,14...0,34 mm <sup>2</sup>   AWG26...22	WAKC3S	8019714
		4, A	32V	4A	2,9...5,1 mm	0,14...0,34 mm <sup>2</sup>   AWG26...22	WAKC4S	8019718
	现场接线连接器 母头, 弯型, M12 绝缘层剥离连接	4, A	32V	4A	4...5,1 mm	max. 0,5 mm <sup>2</sup>	WWAKC4S	8019719
	现场接线连接器 公头, 直型, M12 绝缘层剥离连接	3, A	32V	4A	2,9...5,1 mm	0,14...0,34 mm <sup>2</sup>   AWG26...22	WASC3S	8019712
		4, A	32V	4A	2,9...5,1 mm	0,14...0,34 mm <sup>2</sup>   AWG26...22	WASC4S	8019716

		顶端						
		针脚	最大电压	最大电流	电缆出口	连接横截面积	产品描述	物料编号
	现场接线连接器 公头, 弯型, M12 绝缘层剥离连接	4, A	32V	4A	4...5,1mm	max. 0,5 mm <sup>2</sup>	WWASC4S	8019717
	现场接线连接器 母头, 直型, M12 焊接连接	12, A	30V	1A	6...8 mm	max. 0,25 mm <sup>2</sup>	WAKC12L	8031858
	现场接线连接器 母头, 弯型, M12 焊接连接	12, A	30V	2A	6...8 mm	max. 0,25 mm <sup>2</sup>	WWAKC12L	8031859
	现场接线连接器 公头, 直型, M12 焊接连接	12, A	30V	2A	6...8 mm	max. 0,25 mm <sup>2</sup>	WASC12L	8031860
	现场接线连接器 公头, 弯型, M12 焊接连接	12, A	30V	2A	6...8 mm	max. 0,25 mm <sup>2</sup>	WWASC12L	8031861
	现场接线连接器 母头, 直型, M12 屏蔽 螺丝夹紧连接	4, A	250V	4A	5...8 mm	max. 0,75 mm <sup>2</sup>	WAKCS4K	8068908
		5, A	125V	4A	5...8 mm	max. 0,75 mm <sup>2</sup>	WAKCS5K	8068910
		8, A	60V	2A	6...8 mm	max. 0,50 mm <sup>2</sup>	WAKCS8K	8035193
	现场接线连接器 公头, 直型, M12 屏蔽 螺丝夹紧连接	4, A	250V	4A	5...8 mm	max. 0,75 mm <sup>2</sup>	WASCS4K	8068909
		5, A	60V	4A	5...8 mm	max. 0,75 mm <sup>2</sup>	WASCS5K	8068911
		8, A	60V	2A	6...8 mm	max. 0,5 mm <sup>2</sup>	WASCS8K	8035192
	现场接线连接器 母头, 直型, M12 屏蔽 焊接连接	12, A	30V	2A	6...8 mm	max. 0,25 mm <sup>2</sup>	WAKCS12L	8052220
	现场接线连接器 公头, 直型, M12 屏蔽 焊接连接	12, A	30V	2A	6...8 mm	max. 0,25 mm <sup>2</sup>	WASCS12L	8037435
	现场接线连接器 母头, 直型, M12 屏蔽 绝缘层剥离连接	8, X	50V <sub>AC</sub>   60V <sub>DC</sub>	0.5A	5...9,7 mm	AWG 26/1 - AWG 22/1, AWG 26/7 - AWG 22/7	IE-WAKCSX8S	8086078
	现场接线连接器 公头, 直型, M12 屏蔽 绝缘层剥离连接	4, D	250V	4A	5...9,7 mm	AWG 24/1 - AWG 22/1, AWG 26/7 - AWG 22/7	IE-WASCSY4S	8065954
		8, X	50V <sub>AC</sub>   60V <sub>DC</sub>	0.5A	5...9,7 mm	AWG 26/1 - AWG 22/1, AWG 26/7 - AWG 22/7	IE-WASCSX8S	8050231

		顶端						
		针脚	最大电压	最大电流	电缆出口	连接横截面积	产品描述	物料编号
	现场接线连接器 母头, 直型, M12 屏蔽 螺丝夹紧连接	5, B	125V	4A	6,5...8,5 mm	max. 0,75 mm <sup>2</sup>	PB-WAKCSW4.5K	8031376
	现场接线连接器 母头, 弯型, M12 屏蔽 螺丝夹紧连接	5, B	125V	4A	6...8 mm	max. 0,75 mm <sup>2</sup>	PB-WWAKCSW4.5K	8040235
	现场接线连接器 公头, 直型, M12 屏蔽 螺丝夹紧连接	5, B	125V	4A	5...8 mm	max. 0,75 mm <sup>2</sup>	PB-WASCSW4.5K	8031375
	现场接线连接器 公头, 弯型, M12 屏蔽 螺丝夹紧连接	5, B	125V	4A	6...8 mm	max. 0,75 mm <sup>2</sup>	PB-WWASCSW4.5K	8040236
	现场接线连接器 母头, 直型, M12 螺丝夹紧连接	3+PE, S	630V <sub>DC</sub>	12A	8...10 mm	max. 1,50 mm <sup>2</sup>	PS-WAKC4K	8063400
		4, T	63V <sub>DC</sub>	12A	8...10 mm	max. 1,50 mm <sup>2</sup>	PT-WAKC4K	8063398
		5, K	630V <sub>DC</sub>	12A	8...13 mm	max. 2,5 mm <sup>2</sup>	PK-WAKC5K	8086298
		5, L	63V <sub>DC</sub>	16A	8...13 mm	max. 2,5 mm <sup>2</sup>	PL-WAKC5K	8086300
	现场接线连接器 公头, 直型, M12 螺丝夹紧连接	3+PE, S	630V <sub>DC</sub>	12A	8...10 mm	max. 1,50 mm <sup>2</sup>	PS-WASC4K	8063399
		4, T	63V <sub>DC</sub>	12A	8...10 mm	max. 1,50 mm <sup>2</sup>	PT-WASC4K	8063397
		5, K	630V <sub>DC</sub>	12A	8...13 mm	max. 2,5 mm <sup>2</sup>	PK-WASC5K	8086297
		5, L	63V <sub>DC</sub>	16A	8...13 mm	max. 2,5 mm <sup>2</sup>	PL-WASC5K	8086299
	现场接线连接器 公头, 双密封盖, 直型, M12 螺丝夹紧连接	4, A	250V	4A	2 x Ø 2,1-3 mm   Ø 4-5 mm	0,75 mm <sup>2</sup>   AWG18	FSMC4K	8017231
		5, A	125V	4A	2 x Ø 2,1-3 mm   Ø 4-5 mm	0,75 mm <sup>2</sup>   AWG18	FSMC5K	8032825
	现场接线连接器 母头, 直型, M8 螺丝夹紧连接	3	60V	4A	3,5...5 mm	max. 0,5 mm <sup>2</sup>	SKPC3K	8004833
		4	30V	4A	3,5...5 mm	max. 0,5 mm <sup>2</sup>	SKPC4K	8004834
	现场接线连接器 公头, 直型, M8 螺丝夹紧连接	3	60V	4A	3,5...5 mm	max. 0,5 mm <sup>2</sup>	SSPC3K	8004831
		4	30V	4A	3,5...5 mm	max. 0,5 mm <sup>2</sup>	SSPC4K	8004832
	现场接线连接器 母头, 直型, M8 绝缘层剥离连接	3	32V	4A	2,5...5,1 mm	0,14...0,34 mm <sup>2</sup>   AWG26...22	SKPC3S	8019721
		4	32V	4A	2,5...5,1 mm	0,14...0,34 mm <sup>2</sup>   AWG26...22	SKPC4S	8019723
	现场接线连接器 公头, 直型, M8 绝缘层剥离连接	3	32V	4A	2,5...5,1 mm	0,14...0,34 mm <sup>2</sup>   AWG26...22	SSPC3S	8019720
		4	32V	4A	2,5...5,1 mm	0,14...0,34 mm <sup>2</sup>   AWG26...22	SSPC4S	8019722

		顶端						
		针脚	最大电压	最大电流	电缆出口	连接横截面积	产品描述	物料编号
	现场接线连接器 母头, 弯型, M8 焊接连接	3	32V	4A	3,5...5 mm	0,14...0,34 mm <sup>2</sup>   AWG26...22	SWKPC3L	8017351
		4	30V	4A	3,5...5 mm	max. 0,25 mm <sup>2</sup>	SWKPC4L	8017364
	现场接线连接器 公头, 弯型, M8 焊接连接	3	60V	4A	3,5...5 mm	max. 0,25 mm <sup>2</sup>	SWSPC3L	8017365
		4	30V	4A	3,5...5 mm	max. 0,25 mm <sup>2</sup>	SWSPC4L	8017366
	现场接线连接器 母头, 直型, M23 焊接连接	12	150V	8A* 4A**	8...12 mm	连接触点 10,11,12*: 0,75...1,0 mm <sup>2</sup>   其他全部连接触点**: 0,5...0,75 mm <sup>2</sup>	MKCC12L	8013694
		19	125V	10A* 4A**	10...14 mm	连接触点 6,12,19*: 0,75...1,0 mm <sup>2</sup>   其他全部连接触点**: 0,5...0,75 mm <sup>2</sup>	MKCC19L	8013696
	现场接线连接器 母头, 弯型, M23 焊接连接	12	150V	8A* 4A**	8...12 mm	连接触点 9,10,11,12*: 0,75...1,0 mm <sup>2</sup>   其他全部连接触点**: 0,5...0,75 mm <sup>2</sup>	WMKCC12L	8017153
		19	125V	10A* 4A**	10...14 mm	连接触点 6,12,19*: 0,75...1,0 mm <sup>2</sup>   其他全部连接触点**: 0,5...0,75 mm <sup>2</sup>	WMKCC19L	8017151
	现场接线连接器 公头, 直型, RJ45 绝缘层剥离连接	8	50V	1A	5,5...10,5 mm	AWG27/7-AWG22/7 (0,46-0,76mm)   AWG26/1-AWG22/1 (0,4-0,64 mm)	IE-RJ45SCS8	8065955
	密封件, 现场接线连接器, M12						适用于M12x1 现场接线连接器的密封件	8061922

对接连接器命名

连接电缆

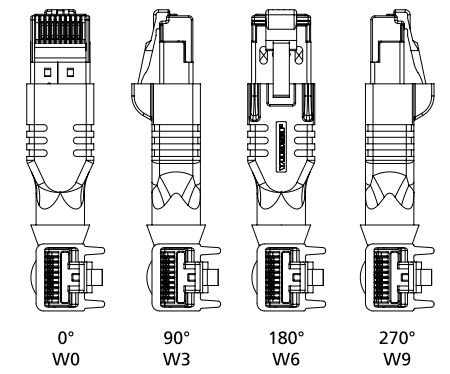
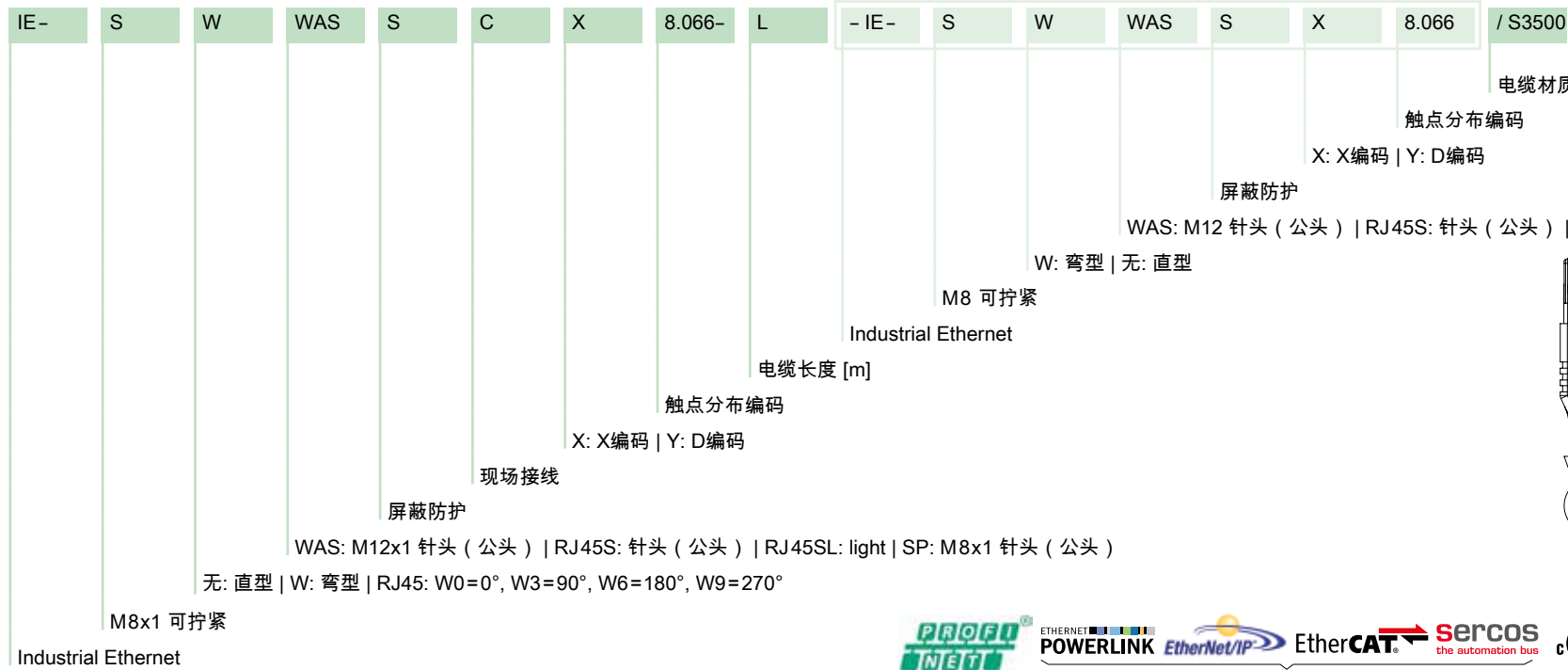

电缆	材料	UL	颜色	传输特性	特性	拖链能力	扭转能力
S3500	PUR/PE	✓	GN	Cat7			
S3800	PUR/PE	✓	RD	Cat5e	Sercos	✓	
S2171	PUR/PE	✓	GN	Cat5e	PROFINET AWG22/7 Typ C	✓	
S3400	PUR/PE	✓	GN	Cat5e		✓	
S4030	PUR	✓	GN	Cat7	PROFINET 4x2xAWG24/7 Typ C		✓
S4031	PUR	✓	GN	Cat6	PROFINET 4x2xAWG26/19 Typ C	✓	
S5058	PUR/PE	✓	BK, 红色竖条纹	Cat5e	EtherCAT P AWG22/7	✓	
S5059	PUR/PE	✓	BK, 红色竖条纹	Cat5e	EtherCAT P AWG24/7	✓	
S5100	PUR/PE	✓	GN	Cat5e	PROFINET robotic AWG22/19 Typ R	✓	✓

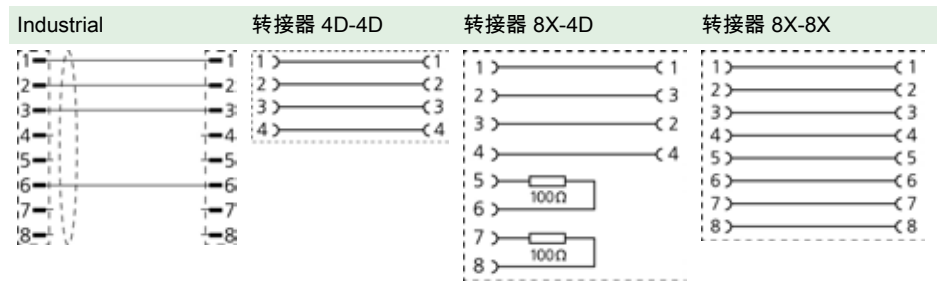









## 工业以太网











技术参数	M12	M8	RJ45	法兰连接
绝缘电阻	$\geq 10^8 \Omega$	$\geq 10^8 \Omega$	$\geq 10^8 \Omega$	$\geq 10^8 \Omega$
电阻	$\leq 5 \text{m}\Omega$	$\leq 5 \text{m}\Omega$	$\leq 5 \text{m}\Omega$	$\leq 5 \text{m}\Omega$
产品环境温度	-30°C...+90°C	-30°C...+90°C	-40°C...+70°C	-30°C...+90°C (* +70°C)
触点材料	合金, 镀金	合金, 镀金	合金, 镀金	合金, 镀金
触头载体材料	塑料, TPU	塑料, PA	塑料	塑料
夹紧基体材料	塑料, TPU	塑料, TPU	塑料, TPE	塑料, TPU
连接螺母材料	合金, 镀镍	合金, 镀镍		
密封(母头)材料				FPM/FKM
防护密封件材料				NBR
插座外壳材料				合金, 铜锌, 镀镍
标准	IEC 61076-2-101/-109	IEC 61076-2-104	IEC 60603-7-5	IEC 61076-2-101/-109
防护等级 ( 安装好 )	IP65, IP67, IP68	IP65, IP67, IP68	IP20	IP65, IP67, IP68
机械寿命周期	>100 插拔次数	>100 插拔次数	>750 插拔次数	>100 插拔次数
污染等级	2	3/2	1	3/2

我们的工业以太网组件, 为各种以太网应用提供全面的系统布线。采用整体包覆成型或现场接线的连接器、插座以及优质电缆, 可以建立一个可靠且不会过时的系统。和ESCHA一样, 这些产品是依据高频标准设计的, 可以100%的实现指定的数据传输性能。

		顶端			电缆			产品描述	L = 电缆长度*		
		针脚	最大电压	最大电流 Δh[mm]	材料	颜色	UL		2m / 1m	5m / 2m	10m / 5m
	延长电缆 母头, 直型, M12 屏蔽 Cat5e	4, D	250V	4A	PUR	GN	○	IE-WAKSY4.029-L/S5100	8088951	8088952	8089476
				4A	PUR	GN	•	IE-WAKSY4.029-L/S2171	8075040	8079563	8080567
	延长电缆 母头, 弯型, M12 屏蔽 Cat5e	4, D	250V	4A	PUR	GN	○	IE-WWAKSY4.029-L/S5100	8088954	8089276	8089277
				4A	PUR	GN	•	IE-WWAKSY4.029-L/S2171	8075044	8079564	8081799
	延长电缆 公头, 直型, M12 屏蔽 Cat5e	4, D	250V	4A	PUR	GN	○	IE-WASSY4.029-L/S5100	8088138	8088139	8088140
				4A	PUR	GN	•	IE-WASSY4.029-L/S2171	8031449	8031450	8031451
				4A	PUR	GN	•	IE-WASSY4.082-L/S3400	8056566	8056567	8056568
	延长电缆 公头, 弯型, M12 屏蔽 Cat5e	4, D	250V	4A	PUR	GN	○	IE-WWASSY4.029-L/S5100	8088141	8088142	8088143
				4A	PUR	GN	•	IE-WWASSY4.029-L/S2171	8044087	8041940	8044088
				4A	PUR	GN	•	IE-WWASSY4.082-L/S3400	8056569	8056570	8056571
	现场接线连接器 公头, 直型, M12 屏蔽 Cat5e 绝缘层剥离连接	4, D	250V	4A				IE-WASCSY4S	8065954		
	延长电缆 公头, 直型, RJ45 屏蔽	4	50V	1A	PUR	GN	•	IE-RJ45SS4.003-L/S2171	8062329	8062330	8062331
				1A	PUR	GN	•	IE-RJ45SS4.003-L/S5100	8088144	8088145	8088146
				1A	PUR	GN	•	IE-RJ45SS8.005-L/S3400	8056581	8056582	8056583
	延长电缆 公头, 弯型, RJ45, 0° 屏蔽 Cat5e	4	50V	1A	PUR	GN		IE-W0RJ45SS8.005-L/S3400	8080677	8080356	8080678
	延长电缆 公头, 弯型, RJ45, 90° 屏蔽 Cat5e	4	50V	1A	PUR	GN		IE-W3RJ45SS8.005-L/S3400	8080679	8079038	8080680
	延长电缆 公头, 弯型, RJ45, 180° 屏蔽 Cat5e	4	50V	1A	PUR	GN		IE-W6RJ45SS8.005-L/S3400	8080681	8080682	8080683









标准连接器的长度:2米,5米,或10米。中继电缆长度:1米,2米或5米。法兰面板安装的电缆长度:0.5米(0.2米)。其他电缆,电缆长度可按照客户要求定制。

• UL 认证 | • UL 准备中

		顶端			电缆			产品描述	L = 电缆长度*		
		针脚	最大电压	最大电流 Δh[mm]	材料	颜色	UL		2m / 1m	5m / 2m	10m / 5m
	延长电缆 公头, 弯型, RJ45, 270° 屏蔽 Cat5e	4	50V	1A	PUR	GN		IE-W9RJ45SS8.005-L/S3400	8080684	8080802	8080994
	现场接线连接器 公头, 直型, RJ45 Cat6A 绝缘层剥离连接	8	50V	1A				IE-RJ45SCS8	8065955		
	法兰 延长电缆 母头, 直型, M12 屏蔽 Cat5e 电缆 前面板安装 ( 不带固定螺丝 )	4, D	250V	4A	PUR	GN		IE-FKSY4.029-L/16/S2171/S3941	8063614	8063615	8063616
				4A	PUR	GN		IE-FKSY4.029-L/16/S5100/S3941	8088984	8088985	8089428
	法兰 母头, 直型, M12 Cat5e PC板-连接 后面板安装 ( 带固定螺丝 )	4, D	250V	4A			•	IE-FHM12KUD4-P/M12/S3525	8074847		
				4A			•	IE-FHM12KUD4-P/M12/S3540	8074846		
				4A			•	IE-FHM12KUD4-P/M12/S3550	8072578		
	法兰 母头, 弯型, M12 屏蔽 PC板-连接 后面板安装 ( 带固定螺丝 )	4, D	250V	4A			•	IE-WFKFSY4-P/12/S3525	8050282		
				4A			•	IE-WFKFSY4-P/12/S3540	8050284		
				4A			•	IE-WFKFSY4-P/12/S3550	8050285		
	法兰 母头, 直型, M12 线芯连接 后面板安装 ( 带固定螺丝 )	4, D	250V	4A			•	IE-FHM12KUD4.029-0,5/M16	8072504		
	法兰 公头, 直型, M12 线芯连接 后面板安装 ( 带固定螺丝 )	4, D	250V	4A			•	IE-FHM12SUD4.029-0,5/M16	8072520		
	法兰 母头, 直型, M12 线芯连接 前面板安装 ( 不带固定螺丝 )	4, D	250V	4A			•	IE-FVM12KUD4.029-0,5/M16	8072505		
	法兰 母头, 直型, M12 线芯连接 前面板安装, 可定位的	4, D	250V	4A			•	IE-FVM12KUD4.029-0,5/M16/S520	8077905		
	法兰 公头, 直型, M12 线芯连接 前面板安装 ( 不带固定螺丝 )	4, D	250V	4A			•	IE-FVM12SUD4.029-0,5/M16	8072521		

标准连接器的长度:2米,5米,或10米。中继电缆长度:1米,2米或5米。法兰面板安装的电线长度:0.5米(0.2米)。其他电缆,电线长度可按照客户要求定制。

• UL 认证 | • UL 准备中

	顶端			电缆			UL	产品描述	L = 电缆长度*		
	针脚	最大电压	最大电流 Δh[mm]	材料	颜色	2m / 1m			5m / 2m	10m / 5m	
	法兰 公头, 直型, M12 线芯连接 前面板安装, 可定位的	4, D	250V	4A			•	IE-FVM12SUD4.029-0,5/M16/S520	8077968		
	法兰 母头, 直型, M12 Cat5e PC板-连接 后面板安装 (带固定螺丝)	4, D	250V	4A	1,0...5,0		•	IE-FHM12KUD4-P/M16	8072576		
	法兰 公头, 直型, M12 Cat5e PC板-连接 后面板安装 (带固定螺丝)	4, D	250V	4A	1,0...5,0		•	IE-FHM12SUD4-P/M16	8072586		
	法兰 延长电缆 母头, 直型, M12 屏蔽 Cat5e 电缆 后面板安装 (带固定螺丝)	4, D	250V	4A	PUR	GN		IE-FKFDSY4.029-L/16/S2171	8063608	8063609	8063610
				4A	PUR	GN		IE-FKFDSY4.029-L/16/S5100	8088147	8088148	8088149
				4A	PUR	GN		IE-FKFDSY4.082-L/16/S3400	8064034	8064035	8064036
	法兰 延长电缆 母头, 弯型, M12 屏蔽 Cat5e 电缆 后面板安装 (带固定螺丝)	4, D	250V	4A	PUR	GN		IE-WFKFDSY4.029-L/16/S2171	8063611	8063612	8063613
				4A	PUR	GN		IE-WFKFDSY4.029-L/16/S5100	8088150	8088151	8088152
	延长电缆 公头, 直型, M8 屏蔽 Cat5e	4	60V	4A	PUR	GN	•	IE-SSPS4.027-L/S3400	8055529	8055530	8055531
	延长电缆 公头, 弯型, M8 屏蔽 Cat5e	4	60V	4A	PUR	GN	•	IE-SWSPS4.027-L/S3400	8055789	8055790	8055791
	连接电缆 母头, 直型, M12 公头, 直型, M12 屏蔽 Cat5e	4, D 4, D	250V	4A	PUR	GN	◦	IE-WAKSY4.029-L-IE-WASSY4.029/S5100	8088168	8088169	8088170
				4A	PUR	GN	•	IE-WAKSY4.029-L-IE-WASSY4.029/S2171	8080564	8080565	8080566
	连接电缆 母头, 直型, M12 公头, 弯型, M12 屏蔽 Cat5e	4, D 4, D	250V	4A	PUR	GN	◦	IE-WAKSY4.029-L-IE-WWASSY4.029/S5100	8088171	8088172	8088173
				4A	PUR	GN	•	IE-WAKSY4.029-L-IE-WWASSY4.029/S2171	8081796	8075047	8081791







标准连接器的长度:2米,5米,或10米。中继电缆长度:1米,2米或5米。法兰面板安装的电线长度:0.5米(0.2米)。其他电缆,电线长度可按照客户要求定制。

• UL 认证 | ◦ UL 准备中

		顶端			电缆			L = 电缆长度*			
		针脚	最大电压	最大电流 Δh[mm]	材料	颜色	UL	产品描述	2m / 1m	5m / 2m	10m / 5m
	连接电缆	4, D	250V	4A	PUR	GN		IE-WWAKSY4.029-L-IE-WASSY4.029/S5100	8088174	8088175	8088176
	母头, 弯型, M12	4, D									
	公头, 直型, M12										
	屏蔽										
	Cat5e										
	连接电缆	4, D	250V	4A	PUR	GN		IE-WWAKSY4.029-L-IE-WASSY4.029/S5100	8088177	8088178	8088179
	母头, 弯型, M12	4, D									
	公头, 弯型, M12										
	屏蔽										
	Cat5e										
	连接电缆	4, D	60V	4A	PUR	GN	o	IE-WASSY4.029-L-IE-WASSY4.029/S5100	8088153	8088154	8088155
	公头, 直型, M12	4, D		4A	PUR	GN	•	IE-WASSY4.029-L-IE-WASSY4.029/S2171	8031558	8031560	8031561
	屏蔽			4A	PUR	GN	•	IE-WASSY4.082-L-IE-WASSY4.082/S3400	8056557	8056558	8056559
	Cat5e										
	连接电缆	4, D	50V	1A	PUR	GN	o	IE-WASSY4.029-L-IE-RJ45SS4.003/S5100	8088162	8088163	8088164
	公头, 直型, M12	4		1A	PUR	GN	•	IE-WASSY4.029-L-IE-RJ45SS4.003/S2171	8061081	8061082	8061083
	公头, 直型, RJ45			1A	PUR	GN	•	IE-WASSY4.082-L-IE-RJ45SS8.005/S3400	8056572	8056573	8056574
	屏蔽										
	Cat5e										
	连接电缆	4, D	60V	4A	PUR	GN		IE-WASSY4.082-L-IE-SSPS4.027/S3400	8055552	8055553	8055554
	公头, 直型, M12	4									
	公头, 直型, M8										
	屏蔽										
	Cat5e										
	母头, 直型, M12	4, D	50V	1A	PUR	GN		IE-FKFDSY4.029-L-IE-RJ45SS4.003/S2171	8064023	8064024	8064025
	公头, 直型, RJ45			1A	PUR	GN		IE-FKFDSY4.029-L-IE-RJ45SS4.003/S5100	8089267	8088945	8088946
	Cat5e			1A	PUR	GN		IE-FKFDSY4.082-L-IE-RJ45SS8.005/S3400	8060876	8063625	8063626
	法兰 延长电缆 连接电缆	4, D	50V	1A	PUR	GN		IE-WFKFDSY4.082-L-IE-RJ45SS8.005/S3400	8069853	8069854	8069855
	母头, 弯型, M12										
	公头, 直型, RJ45										
	屏蔽										
	Cat5e										
	连接电缆	4, D	60V	4A	PUR	GN	o	IE-WWASSY4.029-L-IE-WASSY4.029/S5100	8088156	8088157	8088158
	公头, 弯型, M12	4, D		4A	PUR	GN	•	IE-WWASSY4.029-L-IE-WASSY4.029/S2171	8046398	8044089	8044090
	公头, 直型, M12			4A	PUR	GN	•	IE-WWASSY4.082-L-IE-WASSY4.082/S3400	8056563	8056564	8056565
	屏蔽										
	Cat5e										







标准连接器的长度:2米,5米,或10米。中继电缆长度:1米,2米或5米。法兰面板安装的电缆长度:0.5米(0.2米)。其他电缆,电缆长度可按照客户要求定制。

• UL 认证 | • UL 准备中

		顶端			电缆			L = 电缆长度*			
		针脚	最大电压	最大电流 Δh[mm]	材料	颜色	UL	产品描述	2m / 1m	5m / 2m	10m / 5m
	连接电缆 公头, 弯型, M12 公头, 直型, RJ45 屏蔽 Cat5e	4, D 4	50V	1A	PUR	GN	○	IE-WWASSY4.029-L-IE-RJ45SS4.003/S5100	8088165	8088166	8088167
				1A	PUR	GN	•	IE-WWASSY4.029-L-IE-RJ45SS4.003/S2171	8062317	8062318	8062319
				1A	PUR	GN	•	IE-WWASSY4.082-L-IE-RJ45SS8.005/S3400	8056575	8056576	8056577
	连接电缆 公头, 弯型, M12 公头, 弯型, M12 屏蔽 Cat5e	4, D 4, D	60V	4A	PUR	GN	○	IE-WWASSY4.029-L-IE-WWASSY4.029/S5100	8088159	8088160	8088161
				4A	PUR	GN	•	IE-WWASSY4.029-L-IE-WWASSY4.029/S2171	8046893	8036902	8036903
				4A	PUR	GN	•	IE-WWASSY4.082-L-IE-WWASSY4.082/S3400	8056560	8056561	8056562
	连接电缆 公头, 直型, RJ45 公头, 直型, RJ45 屏蔽 Cat5e 工业的	4 4	50V	1A	PUR	GN	○	IE-RJ45SS4.003-L-IE-RJ45SS4.003/S5100	8088974	8089268	8088975
				1A	PUR	GN	•	IE-RJ45SS4.003-L-IE-RJ45SS4.003/S2171	8062323	8062324	8065056
				1A	PUR	GN	•	IE-RJ45SS8.005-L-IE-RJ45SS8.005/S3400	8056578	8056579	8056580
	连接电缆 公头, 弯型, RJ45, 0° 公头, 直型, RJ45 屏蔽 Cat5e 工业的	4 4	50V	1A	PUR	GN		IE-W0RJ45SS8.005-L-IE-RJ45SS8.005/S3400	8080803	8080804	8080752
	连接电缆 公头, 弯型, RJ45, 90° 公头, 直型, RJ45 屏蔽 Cat5e 工业的	4 4	50V	1A	PUR	GN		IE-W3RJ45SS8.005-L-IE-RJ45SS8.005/S3400	8080805	8080806	8080753
	连接电缆 公头, 弯型, RJ45, 180° 公头, 直型, RJ45 屏蔽 Cat5e 工业的	4 4	50V	1A	PUR	GN		IE-W6RJ45SS8.005-L-IE-RJ45SS8.005/S3400	8080807	8080995	8080754









标准连接器的长度:2米,5米,或10米。中继电缆长度:1米,2米或5米。法兰面板安装的电线长度:0.5米(0.2米)。其他电缆,电线长度可按照客户要求定制。

• UL 认证 | • UL 准备中

		顶端			电缆			L = 电缆长度*			
		针脚	最大电压	最大电流 Δh[mm]	材料	颜色	UL	产品描述	2m / 1m	5m / 2m	10m / 5m
	连接电缆 公头, 弯型, RJ45, 270° 公头, 直型, RJ45 屏蔽 Cat5e 工业的	4 4	50V	1A	PUR	GN		IE-W9RJ45SS8.005-L-IE-RJ45SS8.005/S3400	8080808	8080997	8080755
	连接电缆 公头, 直型, RJ45 light 公头, 直型, RJ45 light 屏蔽 Cat5e 工业的	4 4	50V	1A	PUR	GN		IE-RJ45SLS8.005-L-IE-RJ45SLS8.005/S3400	8069789	8071964	8075806
	连接电缆 母头, 直型, M8 公头, 直型, M8 屏蔽 Cat5e	4 4	60V	4A	PUR	GN	•	IE-SKPS4.027-L-IE-SSPS4.027/S3400	8055535	8055537	8055538
	连接电缆 公头, 直型, M8 公头, 直型, M8 屏蔽 Cat5e	4 4	60V	4A	PUR	GN		IE-SSPS4.027-L-IE-SSPS4.027/S3400	8055532	8055533	8055534
	连接电缆 公头, 直型, M8 公头, 直型, RJ45 屏蔽 Cat5e	4 4	50V	1A	PUR	GN		IE-SSPS4.027-L-IE-RJ45SS8.005/S3400	8055536	8055539	8055540
	连接电缆 公头, 弯型, M8 公头, 直型, M8 屏蔽 Cat5e	4 4	60V	4A	PUR	GN		IE-SWSPS4.027-L-IE-SSPS4.027/S3400	8055795	8055796	8055797
	连接电缆 公头, 弯型, M8 公头, 弯型, M8 屏蔽 Cat5e	4 4	60V	4A	PUR	GN		IE-SWSPS4.027-L-IE-SWSPS4.027/S3400	8055801	8055802	8055804
	延长电缆 公头, 直型, M12 屏蔽 Cat5e	4, D	250V	4A	PUR	RD	•	IE-WASSY4.029-L/S3800	8055493	8055494	8055495

标准连接器的长度:2米,5米,或10米。中继电缆长度:1米,2米或5米。法兰面板安装的电线长度:0.5米(0.2米)。其他电缆,电线长度可按照客户要求定制。









• UL 认证 | • UL 准备中

		顶端			电缆			L = 电缆长度*			
		针脚	最大电压	最大电流 Δh[mm]	材料	颜色	UL	产品描述	2m / 1m	5m / 2m	10m / 5m
	延长电缆 公头, 弯型, M12 屏蔽 Cat5e	4, D	250V	4A	PUR	RD	•	IE-WWASSY4.029-L/S3800	8055499	8055500	8055501
	现场接线连接器 公头, 直型, M12 屏蔽 Cat5e 绝缘层剥离连接	4, D	250V	4A				IE-WASCSY4S	8065954		
	延长电缆 公头, 直型, RJ45 屏蔽 Cat5e	4	50V	1A	PUR	RD	•	IE-RJ45SS4.003-L/S3800	8062332	8062333	8062334
	现场接线连接器 公头, 直型, RJ45 Cat6A 绝缘层剥离连接	8	50V	1A				IE-RJ45SCS8	8065955		
	法兰 延长电缆 母头, 直型, M12 屏蔽 Cat5e 电缆 前面板安装 ( 不带固定螺丝 )	4, D	250V	4A	PUR	RD		IE-FKSY4.029-L/16/S3800/S3801	8063605	8063606	8063607
	法兰 母头, 直型, M12 Cat5e PC板-连接 后面板安装 ( 带固定螺丝 )	4, D	250V	4A			•	IE-FKFDY4-P/16/S38	8055849		
	法兰 母头, 弯型, M12 屏蔽 Cat5e PC板-连接 后面板安装 ( 带固定螺丝 )	4, D	250V	4A				IE-WFKFSY4-P/12/S3825	8055850		
				1,0...2,5				IE-WFKFSY4-P/12/S3840	8055851		
				2,5...4,0				IE-WFKFSY4-P/12/S3850	8055852		
				4,0...5,0							
	法兰 延长电缆 母头, 直型, M12 屏蔽 Cat5e 电缆 后面板安装 ( 带固定螺丝 )	4, D	250V	4A	PUR	RD		IE-FKFDSY4.029-L/16/S3800/S38	8063599	8063600	8063601
	法兰 延长电缆 母头, 弯型, M12 屏蔽 Cat5e 电缆 后面板安装 ( 带固定螺丝 )	4, D	250V	4A	PUR	RD		IE-WFKFDSY4.029-L/16/S3800/S38	8063602	8063603	8063604

标准连接器的长度:2米,5米,或10米。中继电缆长度:1米,2米或5米。法兰面板安装的电线长度:0.5米(0.2米)。其他电缆,电线长度可按照客户要求定制。











• UL 认证 | • UL 准备中



		顶端			电缆			L = 电缆长度*			
		针脚	最大电压	最大电流 Δh[mm]	材料	颜色	UL	产品描述	2m / 1m	5m / 2m	10m / 5m
	连接电缆 公头, 直型, M12 公头, 直型, M12 屏蔽 Cat5e	4, D 4, D	60V	4A	PUR	RD	•	IE-WASSY4.029-L-IE-WASSY4.029/S3800	8055496	8055497	8055498
	连接电缆 公头, 直型, M12 公头, 直型, RJ45 屏蔽 Cat5e	4, D 4	50V	1A	PUR	RD	•	IE-WASSY4.029-L-IE-RJ45SS4.003/S3800	8061084	8061085	8061086
	法兰 延长电缆 连接电缆 母头, 直型, M12 公头, 直型, RJ45 屏蔽 Cat5e	4, D	50V	1A	PUR	RD		IE-FKFDSY4.029-L-IE-RJ45SS4.003/S3800	8064026	8064027	8064028
	连接电缆 公头, 弯型, M12 公头, 直型, M12 屏蔽 Cat5e	4, D 4, D	60V	4A	PUR	RD	•	IE-WWASSY4.029-L-IE-WASSY4.029/S3800	8055502	8055503	8055504
	连接电缆 公头, 弯型, M12 公头, 直型, RJ45 屏蔽 Cat5e	4, D 4	50V	1A	PUR	RD	•	IE-WWASSY4.029-L-IE-RJ45SS4.003/S3800	8062320	8062321	8062322
	连接电缆 公头, 弯型, M12 公头, 弯型, M12 屏蔽 Cat5e	4, D 4, D	60V	4A	PUR	RD	•	IE-WWASSY4.029-L-IE-WWASSY4.029/S3800	8055505	8055506	8055507
	连接电缆 公头, 直型, RJ45 公头, 直型, RJ45 屏蔽 Cat5e 工业的	4 4	50V	1A	PUR	RD	•	IE-RJ45SS4.003-L-IE-RJ45SS4.003/S3800	8062326	8062327	8062328
	转接器 母头, 直型, M12 母头, 直型, M12 屏蔽 Cat5e	4, D 4, D	250V	4A				IE-WAKSY4-IE-WAKSY4	8065952		









标准连接器的长度:2米,5米,或10 米。中继电缆长度:1米,2米或5米。法兰面板安装的电线长度:0.5米(0.2米)。其他电缆,电线长度可按照客户要求定制。

• UL 认证 | • UL 准备中

		顶端			电缆			L = 电缆长度*			
		针脚	最大电压	最大电流 Δh[mm]	材料	颜色	UL	产品描述	2m / 1m	5m / 2m	10m / 5m
	转换器 母头, 直型, M12 母头, 直型, M12 屏蔽 Cat5e	8, X 4, D	50V <sub>AC</sub>   60V <sub>DC</sub>	0.5A				IE-WAKSX8-IE-WAKSY4	8065950		
	直通穿墙式 母头, 直型, M12 母头, 直型, RJ45 屏蔽 Cat5e	4, D 8	50V <sub>AC/DC</sub>	0.2A				IE-FKFDSY4-RJ45KS	8069793		
后面板安装 (带固定螺丝)											
	直通穿墙式 母头, 弯型, M12 母头, 直型, RJ45 屏蔽 Cat5e	4, D 8	50V <sub>AC/DC</sub>	0.2A				IE-WFKFDSY4-RJ45KS	8069794		
后面板安装 (带固定螺丝)											
	延长电缆 公头, 直型, M12 屏蔽 Cat6A	8, X	50V <sub>AC</sub>   60V <sub>DC</sub>	0.5A	PUR	GN	•	IE-WASSX8.066-L/S3500	8049457	8049458	8049459
	延长电缆 公头, 直型, M12 屏蔽 Cat6A	8, X	50V <sub>AC</sub>   60V <sub>DC</sub>	0.5A	PUR	GN	•	IE-WASSX8.066-L/S4030	8063566	8063567	8063568
	延长电缆 公头, 直型, M12 屏蔽 Cat6A	8, X	50V <sub>AC</sub>   60V <sub>DC</sub>	0.5A	PUR	GN	•	IE-WASSX8.066-L/S4031	8063578	8063579	8063580
	延长电缆 公头, 弯型, M12 屏蔽 Cat6A	8, X	50V <sub>AC</sub>   60V <sub>DC</sub>	0.5A	PUR	GN	•	IE-WWASSX8.066-L/S3500	8055441	8055442	8055443
	延长电缆 公头, 直型, RJ45 屏蔽 Cat6A	8	50V	1A	PUR	GN	•	IE-RJ45SS8.002-L/S3500	8052214	8052215	8052216
	现场接线连接器 公头, 直型, RJ45 Cat6A 绝缘层剥离连接	8	50V	1A				IE-RJ45SCS8	8065955		
	法兰 母头, 直型, M12 屏蔽 Cat6A PC板-连接 前面板安装 (带固定螺丝)	8, X	50V <sub>AC</sub>   60V <sub>DC</sub>	0.5A	0,9...2,5		•	IE-FKDSX8-P/12	8050232		

标准连接器的长度:2米,5米,或10米。中继电缆长度:1米,2米或5米。法兰面板安装的电线长度:0.5米(0.2米)。其他电缆,电线长度可按照客户要求定制。

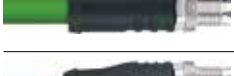
• UL 认证 | • UL 准备中

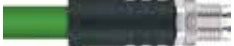
		顶端			电缆			L = 电缆长度*				
		针脚	最大电压	最大电流 Δh[mm]	材料	颜色	UL	产品描述	2m / 1m	5m / 2m	10m / 5m	
	法兰 母头, 直型, M12 屏蔽 Cat6A PC板-连接 后面板安装 (带固定螺丝)	8, X	50V <sub>AC</sub>   60V <sub>DC</sub>	0.5A			•	IE-FHM12KSX8P/PG9	8079981			
	法兰 母头, 弯型, M12 屏蔽 Cat6A PC板-连接 后面板安装 (带固定螺丝)	8, X	50V <sub>AC</sub>   60V <sub>DC</sub>	0.5A	1,0...2,5		•	IE-WFKFSX8-P/12/S3525	8059345			
				0.5A	2,5...4,0			IE-WFKFSX8-P/12/S3540	8059346			
				0.5A	4,0...5,0			IE-WFKFSX8-P/12/S3550	8059347			
	法兰 延长电缆 母头, 直型, M12 屏蔽 Cat6A 电缆 后面板安装 (带固定螺丝)	8, X	50V <sub>AC</sub>   60V <sub>DC</sub>	0.5A		PUR	GN	IE-FKFDSX8.066-L/S3500	8061148	8061149	8061150	
				0.5A		PUR	GN		IE-FKFDSX8.066-L/S4030	8063572	8063573	8063574
	法兰 延长电缆 母头, 直型, M12 屏蔽 Cat6A 电缆 后面板安装 (带固定螺丝)	8, X	50V <sub>AC</sub>   60V <sub>DC</sub>	0.5A		PUR	GN	IE-FKFDSX8.066-L/S4031	8063584	8063585	8063586	
				0.5A		PUR	GN		IE-FKFDSX8.066-L/S4031	8063584	8063585	8063586
	连接电缆 公头, 直型, M12 公头, 直型, M12 屏蔽 Cat6A	8, X	50V <sub>AC</sub>   60V <sub>DC</sub>	0.5A		PUR	GN	•	IE-WASSX8.066-L-IE-WASSX8.066/S3500	8048865	8049460	8049461
		8, X										
	连接电缆 公头, 直型, M12 公头, 直型, M12 屏蔽 Cat6A	8, X	50V <sub>AC</sub>   60V <sub>DC</sub>	0.5A		PUR	GN	•	IE-WASSX8.066-L-IE-WASSX8.066/S4030	8063563	8063564	8063565
		8, X										
	连接电缆 公头, 直型, M12 公头, 直型, RJ45 屏蔽 Cat6A	8, X	50V	0.5A		PUR	GN	•	IE-WASSX8.066-L-IE-RJ45SS8.002/S3500	8053444	8053288	8053289
		8										
	法兰 延长电缆 连接电缆 母头, 直型, M12 公头, 直型, M12 Cat6A	8, X	50V <sub>AC</sub>   60V <sub>DC</sub>	0.5A		PUR	GN	•	IE-FKFDSX8.066-L-IE-WASSX8.066/S3500	8061289	8061290	8061291
		8, X										
	法兰 延长电缆 连接电缆 母头, 直型, M12 公头, 直型, M12 Cat6A	8, X	50V <sub>AC</sub>   60V <sub>DC</sub>	0.5A		PUR	GN	•	IE-FKFDSX8.066-L-IE-WASSX8.066/S4030	8063569	8063570	8063571
		8, X										
	法兰 延长电缆 连接电缆 母头, 直型, M12 公头, 直型, M12 Cat6A	8, X	50V <sub>AC</sub>   60V <sub>DC</sub>	0.5A		PUR	GN	•	IE-FKFDSX8.066-L-IE-WASSX8.066/S4031	8063581	8063582	8063583
		8, X										

标准连接器的长度:2米,5米,或10米。中继电缆长度:1米,2米或5米。法兰面板安装的电线长度:0.5米(0.2米)。其他电缆,电线长度可按照客户要求定制。

• UL 认证 | • UL 准备中









		顶端			电缆			L = 电缆长度*			
		针脚	最大电压	最大电流 Δh[mm]	材料	颜色	UL	产品描述	2m / 1m	5m / 2m	10m / 5m
	法兰 延长电缆 连接电缆 母头, 直型, M12 公头, 直型, RJ45 屏蔽 Cat6A	8, X 8	50V	0.5A	PUR	GN		IE-FKFDXSX8.066-L-IE-RJ45SS8.002/S3500	8061295	8061296	8061297
	连接电缆 公头, 弯型, M12 公头, 直型, M12 屏蔽 Cat6A	8, X 8, X	50V <sub>AC</sub>   60V <sub>DC</sub>	0.5A	PUR	GN	•	IE-WWASSX8.066-L-IE-WASSX8.066/S3500	8055444	8055445	8055446
	连接电缆 公头, 弯型, M12 公头, 直型, RJ45 屏蔽 Cat6A	8, X 8	50V	0.5A	PUR	GN	•	IE-WWASSX8.066-L-IE-RJ45SS8.002/S3500	8055447	8055448	8055449
	连接电缆 公头, 直型, RJ45 公头, 直型, RJ45 屏蔽 Cat6A T568B	8 8	50V	1A	PUR	GN	•	IE-RJ45SS8.002-L-IE-RJ45SS8.002/S3500	8052205	8048829	8048830
	转接器 母头, 直型, M12 母头, 直型, M12 屏蔽 Cat6A	8, X 8, X	50V <sub>AC</sub>   60V <sub>DC</sub>	0.5A				IE-WAKSX8-IE-WAKSX8	8065951		
	直通穿墙式 母头, 弯型, M12 母头, 直型, RJ45 屏蔽 Cat6A	8, X 8	50V <sub>AC</sub>   60V <sub>DC</sub>	0.5A				IE-WFKFDXSX8-RJ45KS	8055774		
	后面板安装 (带固定螺丝)										
	直通穿墙式 母头, 直型, M12 母头, 直型, RJ45 屏蔽 Cat6A	8, X 8	50V <sub>AC</sub>   60V <sub>DC</sub>	0.5A				IE-FKFDXSX8-RJ45KS	8055773		
	后面板安装 (带固定螺丝)										
	导线连接器 Cat7 绝缘层剥离连接	8	60V <sub>DC</sub>	0.5A				IE-LVCS8	8055776		

标准连接器的长度:2米,5米,或10米。中继电缆长度:1米,2米或5米。法兰面板安装的电线长度:0.5米(0.2米)。其他电缆,电线长度可按照客户要求定制。

• UL 认证 | • UL 准备中

	顶端			电缆			产品描述	L = 电缆长度*		
	针脚	最大电压	最大电流 Δh[mm]	材料	颜色	UL		2m / 1m	5m / 2m	10m / 5m
 墙壁支架用于工业以太网适配器							Befestigungswinkel IE-Adapter	8065953		
 转接器 母头, 直型, RJ45	8	50V <sub>AC/DC</sub>	1A				IE-RJ45KS-RJ45KS	8076629		
 母头, 直型, RJ45 Cat6E	8									
 现场接线连接器 母头, 直型, M12	8, X	50V <sub>AC</sub>   60V <sub>DC</sub>	0.5A				IE-WAKCSX8S	8086078		
屏蔽 Cat6A 绝缘层剥离连接										
 现场接线连接器 公头, 直型, M12	8, X	50V <sub>AC</sub>   60V <sub>DC</sub>	0.5A				IE-WASCSX8S	8050231		
屏蔽 Cat6A 绝缘层剥离连接										
 延长电缆 母头, 直型, M8	4, D	50V <sub>AC</sub>   60V <sub>DC</sub>	4A	PUR	GN		IE-SKPSD4.071-L/S3400	8089116	8089132	8089136
屏蔽 Cat5e			4A	PUR	GN		IE-SKPSD4.073-L/S2171	8089171	8089172	8089173
 延长电缆 母头, 弯型, M8	4, D	50V <sub>AC</sub>   60V <sub>DC</sub>	4A	PUR	GN		IE-SWKPSD4.071-L/S3400	8089137	8089138	8089139
屏蔽 Cat5e			4A	PUR	GN		IE-SWKPSD4.073-L/S2171	8089175	8089176	8089177
 延长电缆 公头, 直型, M8	4, D	50V <sub>AC</sub>   60V <sub>DC</sub>	4A	PUR	GN		IE-SSPSD4.071-L/S3400	8089140	8089141	8089142
屏蔽 Cat5e			4A	PUR	GN		IE-SSPSD4.073-L/S2171	8089178	8089179	8089180
 延长电缆 公头, 弯型, M8	4, D	50V <sub>AC</sub>   60V <sub>DC</sub>	4A	PUR	GN		IE-SWSPSD4.071-L/S3400	8089143	8089144	8089145
屏蔽 Cat5e			4A	PUR	GN		IE-SWSPSD4.073-L/S2171	8089181	8089182	8089183
 延长电缆 母头, 直型, M8	4, P	50V <sub>AC</sub>   60V <sub>DC</sub>	4A	PUR	BK		IE-SKPSP4.054-L/S5058	8089159	8089160	8089161
屏蔽 Cat5e			4A	PUR	BK		IE-SKPSP4.054-L/S5059	8089147	8089148	8089149
 延长电缆 母头, 弯型, M8	4, P	50V <sub>AC</sub>   60V <sub>DC</sub>	4A	PUR	BK		IE-SWKPSP4.054-L/S5058	8089162	8089163	8089164
屏蔽 Cat5e			4A	PUR	BK		IE-SWKPSP4.054-L/S5059	8089150	8089151	8089152

标准连接器的长度:2米,5米,或10米。中继电缆长度:1米,2米或5米。法兰面板安装的电线长度:0.5米(0.2米)。其他电缆,电线长度可按照客户要求定制。  
• UL 认证 | • UL 准备中

		顶端			电缆			L = 电缆长度*			
		针脚	最大电压	最大电流 Δh[mm]	材料	颜色	UL	产品描述	2m / 1m	5m / 2m	10m / 5m
	延长电缆 公头, 直型, M8 屏蔽 Cat5e	4, P	50V <sub>AC</sub>   60V <sub>DC</sub>	4A	PUR	BK		IE-SSPSP4.054-L/S5058	8089165	8089166	8089167
				4A	PUR	BK		IE-SSPSP4.054-L/S5059	8089153	8089154	8089155
	延长电缆 公头, 弯型, M8 屏蔽 Cat5e	4, P	50V <sub>AC</sub>   60V <sub>DC</sub>	4A	PUR	BK		IE-SWSPSP4.054-L/S5058	8089168	8089169	8089170
				4A	PUR	BK		IE-SWSPSP4.054-L/S5059	8089156	8089157	8089158
	连接电缆 母头, 直型, M8 公头, 直型, M8 屏蔽 Cat5e	4, D	50V <sub>AC</sub>   60V <sub>DC</sub>	4A	PUR	GN		IE-SKPSD4.071-L-IE-SSPSD4.071/S3400	8089224	8089225	8089226
		4, D		4A	PUR	GN		IE-SKPSD4.073-L-IE-SSPSD4.073/S2171	8089239	8089240	8089241
	连接电缆 母头, 弯型, M8 公头, 弯型, M8 屏蔽 Cat5e	4, D	50V <sub>AC</sub>   60V <sub>DC</sub>	4A	PUR	GN		IE-SWKPSD4.071-L-IE-SWSPSD4.071/S3400	8089227	8089228	8089229
		4, D		4A	PUR	GN		IE-SWKPSD4.073-L-IE-SWSPSD4.073/S2171	8089236	8089237	8089238
	连接电缆 公头, 直型, M8 公头, 直型, M8 屏蔽 Cat5e	4, D	50V <sub>AC</sub>   60V <sub>DC</sub>	4A	PUR	GN		IE-SSPSD4.071-L-IE-SSPSD4.071/S3400	8089218	8089219	8089220
		4, D		4A	PUR	GN		IE-SSPSD4.073-L-IE-SSPSD4.073/S2171	8089230	8089231	8089232
	连接电缆 公头, 弯型, M8 公头, 弯型, M8 屏蔽 Cat5e	4, D	50V <sub>AC</sub>   60V <sub>DC</sub>	4A	PUR	GN		IE-SWSPSD4.071-L-IE-SWSPSD4.071/S3400	8089221	8089222	8089223
		4, D		4A	PUR	GN		IE-SWSPSD4.073-L-IE-SWSPSD4.073/S2171	8089233	8089234	8089235
	连接电缆 母头, 直型, M8 公头, 直型, M8 屏蔽 Cat5e	4, P	50V <sub>AC</sub>   60V <sub>DC</sub>	4A	PUR	BK		IE-SKPSP4.054-L-IE-SSPSP4.054/S5058	8089200	8089201	8089202
		4, P		4A	PUR	BK		IE-SKPSP4.054-L-IE-SSPSP4.054/S5059	8089212	8089213	8089214
	连接电缆 母头, 弯型, M8 公头, 弯型, M8 屏蔽 Cat5e	4, P	50V <sub>AC</sub>   60V <sub>DC</sub>	4A	PUR	BK		IE-SWKPSP4.054-L-IE-SWSPSP4.054/S5058	8089203	8089204	8089205
		4, P		4A	PUR	BK		IE-SWKPSP4.054-L-IE-SWSPSP4.054/S5059	8089215	8089216	8089217
	连接电缆 公头, 直型, M8 公头, 直型, M8 屏蔽 Cat5e	4, P	50V <sub>AC</sub>   60V <sub>DC</sub>	4A	PUR	BK		IE-SSPSP4.054-L-IE-SSPSP4.054/S5058	8089193	8089194	8089195
		4, P		4A	PUR	BK		IE-SSPSP4.054-L-IE-SSPSP4.054/S5059	8089206	8089207	8089208

标准连接器的长度:2米,5米,或10米。中继电缆长度:1米,2米或5米。法兰面板安装的电线长度:0.5米(0.2米)。其他电缆,电线长度可按照客户要求定制。

• UL 认证 | • UL 准备中

		顶端			电缆			L = 电缆长度*			
		针脚	最大电压	最大电流 Δh[mm]	材料	颜色	UL	产品描述	2m / 1m	5m / 2m	10m / 5m
	连接电缆	4, P	50V <sub>AC</sub>   60V <sub>DC</sub>	4A	PUR	BK		IE-SWSPSP4.054-L-IE-SWSPSP4.054/S5058	8089196	8089197	8089198
	公头, 弯型, M8 屏蔽	4, P		4A	PUR	BK		IE-SWSPSP4.054-L-IE-SWSPSP4.054/S5059	8089209	8089210	8089211
	法兰 母头, 直型, M8 屏蔽 Cat5e, PC板-连接 后面板安装 (带固定螺丝)	4, D	50V <sub>AC</sub>   60V <sub>DC</sub>	4A				IE-FHM8KSD4-P/M10	8089337		
	法兰 公头, 直型, M8 屏蔽 Cat5e, PC板-连接 后面板安装 (带固定螺丝)	4, D	50V <sub>AC</sub>   60V <sub>DC</sub>	4A				IE-FHM8SSD4-P/M8	8089338		
	法兰 母头, 弯型, M8 屏蔽 Cat5e, PC板-连接 后面板安装 (带固定螺丝)	4, D	50V <sub>AC</sub>   60V <sub>DC</sub>	4A				IE-WFHM8KSD4-P/M10	8089339		
	法兰 公头, 弯型, M8 屏蔽 Cat5e, PC板-连接 后面板安装 (带固定螺丝)	4, D	50V <sub>AC</sub>   60V <sub>DC</sub>	4A				IE-WFHM8SSD4-P/M8	8089340		
	法兰 母头, 直型, M8 屏蔽 Cat5e, PC板-连接 后面板安装 (带固定螺丝)	4, P	50V <sub>AC</sub>   60V <sub>DC</sub>	4A				IE-FHM8KSP4-P/M10	8089341		
	法兰 公头, 直型, M8 屏蔽 Cat5e, PC板-连接 后面板安装 (带固定螺丝)	4, P	50V <sub>AC</sub>   60V <sub>DC</sub>	4A				IE-FHM8SSP4-P/M8	8089342		
	法兰 母头, 弯型, M8 屏蔽 Cat5e, PC板-连接 后面板安装 (带固定螺丝)	4, P	50V <sub>AC</sub>   60V <sub>DC</sub>	4A				IE-WFHM8KSP4-P/M10	8089343		
	法兰 公头, 弯型, M8 屏蔽 Cat5e, PC板-连接 后面板安装 (带固定螺丝)	4, P	50V <sub>AC</sub>   60V <sub>DC</sub>	4A				IE-WFHM8SSP4-P/M8	8089344		

标准连接器的长度:2米,5米,或10米。中继电缆长度:1米,2米或5米。法兰面板安装的电线长度:0.5米(0.2米)。其他电缆,电线长度可按照客户要求定制。

• UL 认证 | • UL 准备中

命名

IE-	W0	RJ45	S	S	8.002-	L	-IE-	RJ45	S	S	8.002	/S510	YE
-----	----	------	---	---	--------	---	------	------	---	---	-------	-------	----

IE- Industrial Ethernet

W0: 无: 直型 | W: 弯型 | W0=0°, W3=90°, W6=180°, W9=270°

RJ45: 类型 RJ45

S: 针头 (公头)

8.002: 触点分布编码

/S510: 电缆材质

YE: 电缆外护套颜色

L: 电缆长度 [m]

-IE-: Industrial Ethernet

RJ45: 类型 RJ45

S: 针头 (公头)

S: 屏蔽防护

8.002: 触点分布编码

/S510: 屏蔽防护

YE: 类型 RJ45

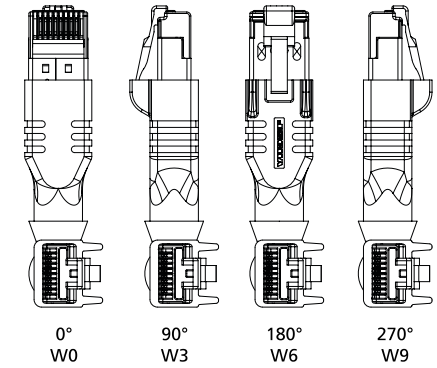

接插件



电缆	材料	UL	颜色	传输特性	拖链能力
S510	PVC/PE		GY, RD, YE, BU, GN	Cat5e	
S620	HFC/PE	✓	GY, RD, YE, BU, GN, BK	Cat7	
S3400	PUR/PP	✓	GN	Cat5e	✓

Industrial

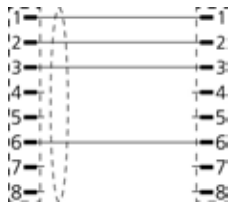























## RJ45 接插件

技术参数	RJ45
绝缘电阻	$\geq 10^8 \Omega$
电阻	$\leq 5 m\Omega$
产品环境温度	$-40^\circ\text{C} \dots +70^\circ\text{C}$
触点材料	合金, 铜锌, 镀金
触头载体材料	塑料
夹紧基体材料	塑料, TPE, 黑色
标准	IEC 60603-7-5
防护等级 (安装好)	IP20
机械寿命周期	>750 插拔次数
污染等级	1

我们RJ45接插件适用于工业应用和结构化建筑布线。我们将发布两款新产品线：一款是带PVC线缆用于Cat5e的应用场合，另一款是带FRNC电缆用于Cat6A的应用场合，它是用4对独立的AWG26的线缆组成。这款新的接插件都要通过IP20的测试。

				L = 电缆长度							
	颜色	UL	产品描述	0,3m	0,5m	1m	2m	5m	7,5m	10m	12,5m
	GY		连接电缆 公头, 直型, RJ45 公头, 直型, RJ45 Cat5e T568B IE-RJ45SS8.002-L-IE-RJ45SS8.002/S510GY	8068494	8068495	8068496	8068497	8068499	8068501	8068502	8068503
	RD		连接电缆 公头, 直型, RJ45 公头, 直型, RJ45 Cat5e T568B IE-RJ45SS8.002-L-IE-RJ45SS8.002/S510RD	8068540	8068541	8068542	8068543	8068545	8068546	8068547	8068548
	YE		连接电缆 公头, 直型, RJ45 公头, 直型, RJ45 Cat5e T568B IE-RJ45SS8.002-L-IE-RJ45SS8.002/S510YE	8068524	8068525	8068526	8068527	8068529	8068530	8068531	8068532
	BU		连接电缆 公头, 直型, RJ45 公头, 直型, RJ45 Cat5e T568B IE-RJ45SS8.002-L-IE-RJ45SS8.002/S510BU	8068556	8068557	8068558	8068559	8068560	8068561	8068562	8068563
	GN		连接电缆 公头, 直型, RJ45 公头, 直型, RJ45 Cat5e T568B IE-RJ45SS8.002-L-IE-RJ45SS8.002/S510GN	8068571	8068572	8068573	8068574	8068576	8068577	8068578	8068579
	BK		连接电缆 公头, 直型, RJ45 公头, 直型, RJ45 Cat6A T568B IE-RJ45SS8.002-L-IE-RJ45SS8.002/S620BK	8076929	8077188	8077189	8077190	8077192	8077193	8077194	8077195
	GY		连接电缆 公头, 直型, RJ45 公头, 直型, RJ45 Cat6A T568B IE-RJ45SS8.002-L-IE-RJ45SS8.002/S620GY	8077337	8077338	8077339	8077340	8077342	8077343	8077344	8077345
	RD		连接电缆 公头, 直型, RJ45 公头, 直型, RJ45 Cat6A T568B IE-RJ45SS8.002-L-IE-RJ45SS8.002/S620RD	8077287	8077288	8077289	8077290	8077292	8077293	8077294	8077295
	YE		连接电缆 公头, 直型, RJ45 公头, 直型, RJ45 Cat6A T568B IE-RJ45SS8.002-L-IE-RJ45SS8.002/S620YE	8077320	8077321	8077322	8077323	8077325	8077326	8077327	8077328

标准连接器的长度:2米,5米,或10米。中继电缆长度:1米,2米或5米。法兰面板安装的电线长度:0.5米(0.2米)。其他电缆,电线长度可按照客户要求定制。

				L = 电缆长度							
	颜色	UL	产品描述	0,3m	0,5m	1m	2m	5m	7,5m	10m	12,5m
	连接电缆 公头, 直型, RJ45 公头, 直型, RJ45 Cat6A T568B	BU	IE-RJ45SS8.002-L-IE-RJ45SS8.002/S620BU	8077304	8077305	8077306	8077307	8077309	8077310	8077311	8077312
	连接电缆 公头, 直型, RJ45 公头, 直型, RJ45 Cat6A T568B	GN	IE-RJ45SS8.002-L-IE-RJ45SS8.002/S620GN	8077354	8077465	8077466	8077467	8077469	8077470	8077471	8077472
	连接电缆 公头, 直型, RJ45 公头, 直型, RJ45 Cat6A Crossover	BK	IE-RJ45SS8.002-L-IE-RJ45SS8.012/S620BK	8076930	8077149	8077479	8077480	8077482	8077483	8077484	8077485
	连接电缆 公头, 直型, RJ45 公头, 直型, RJ45 Cat6A Crossover	GY	IE-RJ45SS8.002-L-IE-RJ45SS8.012/S620GY	8077555	8077556	8077557	8077558	8077559	8077561	8077562	8077563
	连接电缆 公头, 直型, RJ45 公头, 直型, RJ45 Cat6A Crossover	RD	IE-RJ45SS8.002-L-IE-RJ45SS8.012/S620RD	8077492	8077493	8077494	8077495	8077497	8077498	8077499	8077500
	连接电缆 公头, 直型, RJ45 公头, 直型, RJ45 Cat6A Crossover	YE	IE-RJ45SS8.002-L-IE-RJ45SS8.012/S620YE	8077510	8077511	8077512	8077514	8077515	8077516	8077517	8077518
	连接电缆 公头, 直型, RJ45 公头, 直型, RJ45 Cat6A Crossover	BU	IE-RJ45SS8.002-L-IE-RJ45SS8.012/S620BU	8077540	8077541	8077542	8077543	8077545	8077546	8077547	8077548
	连接电缆 公头, 直型, RJ45 公头, 直型, RJ45 Cat6A Crossover	GN	IE-RJ45SS8.002-L-IE-RJ45SS8.012/S620GN	8077525	8077526	8077527	8077528	8077530	8077531	8077532	8077533
	连接电缆 公头, 直型, RJ45 light 公头, 直型, RJ45 light 屏蔽 Cat5e 工业的	GN	IE-RJ45SLS8.005-L-IE-RJ45SLS8.005/S3400	8070278	8070956	8069789	8071964	8075806	8075807	8075808	8075809

标准连接器的长度:2米,5米,或10米。中继电缆长度:1米,2米或5米。法兰面板安装的电线长度:0.5米(0.2米)。其他电缆,电线长度可按照客户要求定制。

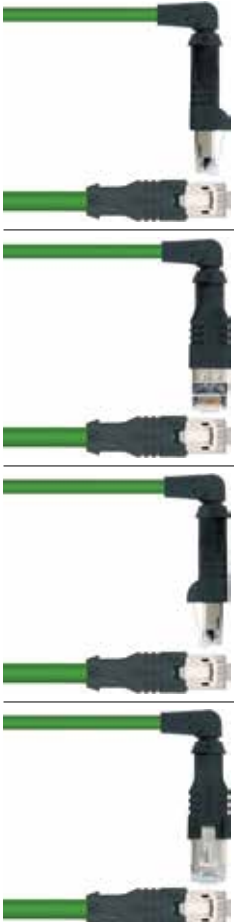
				L = 电缆长度							
	颜色	UL	产品描述	0,3m	0,5m	1m	2m	5m	7,5m	10m	12,5m
 <p>接 插 件</p>	GN		连接电缆 公头, 弯型, RJ45, 0° 公头, 直型, RJ45 屏蔽 Cat5e 工业的				8080803	8080804	8080752		
	GN		连接电缆 公头, 弯型, RJ45, 90° 公头, 直型, RJ45 屏蔽 Cat5e 工业的				8080805	8080806	8080753		
	GN		连接电缆 公头, 弯型, RJ45, 180° 公头, 直型, RJ45 屏蔽 Cat5e 工业的				8080807	8080995	8080754		
	GN		连接电缆 公头, 弯型, RJ45, 270° 公头, 直型, RJ45 屏蔽 Cat5e 工业的				8080808	8080997	8080755		

标准连接器的长度:2米,5米,或10米。中继电缆长度:1米,2米或5米。法兰面板安装的电缆长度:0.5米(0.2米)。其他电缆,电缆长度可按照客户要求定制。



命名

连接电缆

PB-	W	WAK	S	W	2.012-	L	- PB-	W	WAS	S	W	2.012	16/	/S1800	S3525	
							Profibus		WAS: M12 针头 (公头)		D编码		锁紧螺纹: M16x1.5或M12x1		S3525	
							L: 电缆长度, 电缆-长度 [m]   P: 面板安装-PC板连接		W: 弯型   无: 直型		屏蔽防护		触点分布编码		另外: 壁厚补偿或触头载体颜色	
							触点分布编码		WAK: M12 孔头 (母头)   WAS: M12 针头 (公头)   FK: M12 前面板安装孔头 (母头)   FKF(D): M12 后面板安装孔头 (母头) (可调节的)		B编码		电缆材质			
							屏蔽防护		W: 弯型   无: 直型		WAK: M12 孔头 (母头)   WAS: M12 针头 (公头)   FK: M12 前面板安装孔头 (母头)   FKF(D): M12 后面板安装孔头 (母头) (可调节的)					
							Profibus									

Profibus



\*不适合 现场接线, PB-WFKFSW5

电缆	材料	UL	颜色	特性	可适应拖链
S1800	PE/PUR	•	VT	PROFIBUS	•

终端连接器 (公头)      T型分离器 屏蔽      Y型分离器 屏蔽

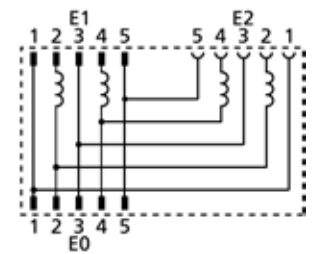
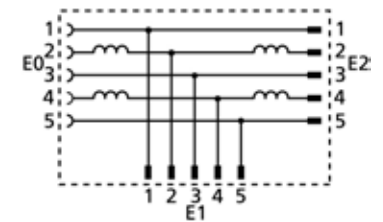
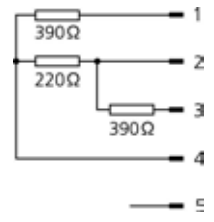













## Profibus









技术参数	接头, 终端插头	法兰连接	T-, Y- 型分离器	现场接线连接器
绝缘电阻	≥10 <sup>8</sup> Ω	≥10 <sup>8</sup> Ω	≥10 <sup>8</sup> Ω	≥10 <sup>8</sup> Ω
电阻	≤ 5mΩ	≤ 5mΩ	≤ 5mΩ	≤ 5mΩ
产品环境温度	-30°C...+90°C	-30°C...+90°C (* +70°C)	-30°C...+90°C	-40°C...+85°C
触点材料	合金, 铜锌, 镀金	合金, 镀金	合金, 镀金	合金, 镀金
触头载体材料	塑料, TPU, 黑色	塑料, TPU, 紫色	塑料, TPU	塑料, PA
夹紧基体材料	塑料, TPU, 黑色	塑料, TPU	塑料, TPU	锌压铸, 镀镍
连接螺母材料	合金, 铜锌, 镀镍			合金, 镀镍
密封(母头)材料	FPM/FKM	FPM/FKM	FPM/FKM	FPM/FKM
防护密封件材料		NBR		
插座外壳材料		合金, 铜锌, 镀镍		
标准	IEC 61076-2-101	IEC 61076-2-101	IEC 61076-2-101	IEC 61076-2-101
防护等级 ( 安装好 )	IP65, IP67, IP68	IP65, IP67, IP68	IP65, IP67, IP68	IP67
机械寿命周期	>100 插拔次数	>100 插拔次数	>100 插拔次数	>100 插拔次数
污染等级	3	3	3	3
连接横截面积				max. 0,75mm <sup>2</sup>
连接类型				螺丝夹紧连接

用于现场总线技术的连接器不得符合总线特殊要求。我们已开发了一款产品系列用来满足PROFIBUS/PROFINET用户的需求(PNO):5芯/B编码带360°屏蔽的连接器、面板安装连接器、T型和Y型分配器。









		顶端			电缆			产品描述	L = 电缆长度*		
		针脚	最大电压	最大电流 Δh[mm]	材料	颜色	UL		2m / 1m	5m / 2m	10m / 5m
	延长电缆 母头, 直型, M12 屏蔽	4, B	60V	4A	PUR	VT	•	PB-WAKSW2.012-L/S1800	8043866	8043868	8043869
	延长电缆 母头, 弯型, M12 屏蔽	4, B	60V	4A	PUR	VT	•	PB-WWAKSW2.012-L/S1800	8043870	8043871	8043872
	延长电缆 公头, 直型, M12 屏蔽	4, B	60V	4A	PUR	VT	•	PB-WASSW2.012-L/S1800	8043873	8043874	8043875
	延长电缆 公头, 弯型, M12 屏蔽	4, B	60V	4A	PUR	VT	•	PB-WWASSW2.012-L/S1800	8043876	8043877	8043878
	法兰 延长电缆 母头, 直型, M12 屏蔽 电缆 前面板安装 (不带固定螺丝)	5, B	60V	4A	PUR	VT	•	PB-FKSW2.012-L/16/S1800/S3941	8063621	8063622	8063623
	法兰 延长电缆 母头, 直型, M12 屏蔽 电缆 后面板安装 (带固定螺丝)	5, B	60V	4A	PUR	VT	•	PB-FKFDSW2.012-L/16/S1800	8061882	8063617	8063618
	法兰 延长电缆 母头, 弯型, M12 屏蔽 电缆 后面板安装 (带固定螺丝)	5, B	60V	4A	PUR	VT	•	PB-WFKFDSW2.012-L/16/S1800	8061881	8063619	8063620
	法兰 母头, 弯型, M12 屏蔽 PC板-连接 后面板安装 (带固定螺丝)	5, B	60V	4A				PB-WFKFSW5-P/12/S3525	8050279		
				4A				PB-WFKFSW5-P/12/S3540	8050280		
				4A				PB-WFKFSW5-P/12/S3550	8050281		
	法兰 母头, 直型, M12 线芯连接 后面板安装 (带固定螺丝)	5, B	60V	4A				PB-FHM12KUB2.012-0,5/M16	8072599		
	法兰 母头, 直型, M12 PC板-连接 后面板安装 (带固定螺丝)	5, B	60V	4A			•	PB-FHM12KUB5-P/M16	8072611		
	法兰 公头, 直型, M12 线芯连接 后面板安装 (带固定螺丝)	5, B	60V	4A				PB-FHM12SUB2.012-0,5/M16	8072633		

标准连接器的长度:2米,5米,或10米。中继电缆长度:1米,2米或5米。法兰面板安装的电线长度:0.5米(0.2米)。其他电缆,电线长度可按照客户要求定制。



		顶端				电缆			产品描述	L = 电缆长度*		
		针脚	最大电压	最大电流	Δh[mm]	材料	颜色	UL		2m / 1m	5m / 2m	10m / 5m
	法兰 公头, 直型, M12 PC板-连接 后面板安装 (带固定螺丝)	5, B	60V	4A				•	PB-FHM12SUB5-P/M16	8072640		
	法兰 母头, 直型, M12 线芯连接 前面板安装 (不带固定螺丝)	5, B	60V	4A					PB-FVM12KUB2.012-0,5/M16	8072602		
	法兰 公头, 直型, M12 线芯连接 前面板安装 (不带固定螺丝)	5, B	60V	4A					PB-FVM12SUB2.012-0,5/M16	8072634		
	法兰 公头, 弯型, M12 屏蔽 PC板-连接 后面板安装 (带固定螺丝)	5, B	60V	4A					PB-WFSFSW5-P/12	8045658		
	法兰 母头, 直型, M12 线芯连接 前面板安装, 可定位的	5, B	60V	4A					PB-FVM12KUB2.012-0,5/M16/S520	8077910		
	法兰 公头, 直型, M12 线芯连接 前面板安装, 可定位的	5, B	60V	4A					PB-FVM12SUB2.012-0,5/M16/S520	8077971		
	连接电缆 母头, 直型, M12 公头, 直型, M12 屏蔽	4, B 4, B	60V	4A		PUR	VT	•	PB-WAKSW2.012-L-PB-WASSW2.012/S1800	8045613	8043867	8043879
	连接电缆 母头, 直型, M12 公头, 弯型, M12 屏蔽	4, B 4, B	60V	4A		PUR	VT	•	PB-WAKSW2.012-L-PB-WWASSW2.012/S1800	8051935	8043884	8043885
	连接电缆 母头, 弯型, M12 公头, 直型, M12 屏蔽	4, B 4, B	60V	4A		PUR	VT	•	PB-WWAKSW2.012-L-PB-WASSW2.012/S1800	8046479	8043881	8043882

标准连接器的长度:2米,5米,或10米。中继电缆长度:1米,2米或5米。法兰面板安装的电线长度:0.5米(0.2米)。其他电缆,电线长度可按照客户要求定制。

		顶端			电缆			L = 电缆长度*			
		针脚	最大电压	最大电流 Δh[mm]	材料	颜色	UL	产品描述	2m / 1m	5m / 2m	10m / 5m
	连接电缆 母头, 弯型, M12 公头, 弯型, M12 屏蔽	4, B 4, B	60V	4A	PUR	VT	•	PB-WWAKSW2.012-L-PB-WWASSW2.012/S1800	8051936	8043887	8043888
	现场接线连接器 母头, 直型, M12 屏蔽 螺丝夹紧连接	5, B	125V	4A				PB-WAKCSW4.5K	8031376		
	现场接线连接器 母头, 弯型, M12 屏蔽 螺丝夹紧连接	5, B	125V	4A				PB-WWAKCSW4.5K	8040235		
	现场接线连接器 公头, 直型, M12 屏蔽 螺丝夹紧连接	5, B	125V	4A				PB-WASCSW4.5K	8031375		
	现场接线连接器 公头, 弯型, M12 屏蔽 螺丝夹紧连接	5, B	125V	4A				PB-WWASCSW4.5K	8040236		
	终端插头 公头, 直型, M12	5, B	60V	4A			•	PB-WASSW4.5-AS	8043520		
	T型分离器 屏蔽	5 5	60V	0.4A				PB-T-WAKSW5-WASSW5-WASSW5	8057719		
	Y型分离器 屏蔽	5 5	60V	0.4A				PB-Y-WASSW5-WASSW5-WAKSW5	8057724		



命名

连接电缆

CD-	W	WAK	C	5.022-	L	- CD-	W	WAS	5.022	16/	/ S2800

电缆材质  
 面板安装拧紧螺纹 M16x1,5  
 触点分布编码  
 WAS: M12 针头 (公头)  
 W: 弯型 | 无: 直型  
 CANopen/DeviceNet  
 L: 电缆长度 [m] | K: 螺旋-夹紧 现场接线连接器  
 触点分布编码  
 现场接线  
 WAK: M12 孔头 (母头) | WAS: M12 针头 (公头) | FK: M12 法兰孔头 (母头) 前-面板 安装 | FKF(D): M12 法兰孔头 (母头) 后-面板 安装 (可调节的)  
 W: 弯型 | 无: 直型  
 CANopen/DeviceNet



电缆	材料	UL	颜色	特性
S2800	PE/PP/PUR	✓	BK	CANopen/DeviceNet

终端连接器 (母头)    终端连接器 (公头)    T型分离器

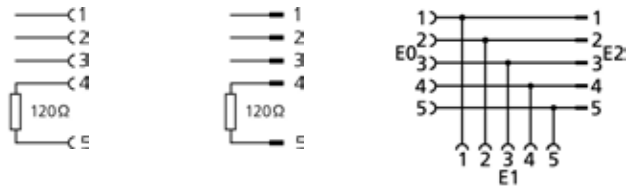













CANopen/DeviceNet









## CANopen/DeviceNet

技术参数	连接头, 终端插头	法兰连接	T型分离器	现场接线连接器
绝缘电阻	≥10 <sup>8</sup> Ω	≥10 <sup>8</sup> Ω	≥108 Ω	≥10 <sup>8</sup> Ω
产品环境温度	-30°C...+90°C	-30°C...+90°C	-30°C...+90°C	-40°C...+85°C
触点材料	合金, 铜锌, 镀金	合金, 镀金	合金, 镀金	合金, 铜锌, 磷青铜锌
触头载体材料	塑料, TPU, 黑色	塑料, TPU, 黑色	塑料, TPU	塑料, PA, 黑色
夹紧基体材料	塑料, TPU, 黑色		塑料, TPU	塑料, PA, 黑色
连接螺母材料	合金, 铜锌, 镀镍		合金, 铜锌, 镀镍	合金, 镀镍
密封(母头)材料	FPM/FKM	FPM/FKM	FPM/FKM	
防护密封件材料		NBR		
插座外壳材料		合金, 铜锌, 镀镍		
标准	IEC 61076-2-101	IEC 61076-2-101	IEC 61076-2-101	IEC 61076-2-101
防护等级 (安装好)	IP65, IP67, IP68	IP65, IP67, IP68	IP65, IP67, IP68	IP67
机械寿命周期	>100 插拔次数	>100 插拔次数	>100 插拔次数	>100 插拔次数
污染等级	3	3	3	3
电缆出口				4...6mm
连接横截面积				max. 0,75 mm <sup>2</sup>

ODVA用户组织要求用5芯M12连接器和面板安装连接器带不含卤素PUR屏蔽两对双绞电缆和标准加蔽线来给信号和供电。当然, UL认证的“细电缆”元件也符合这些要求。此外, 我们提供M12带120Ω的终端电阻(公头和母头)。

		顶端				电缆			产品描述	L = 电缆长度*		
		针脚	最大电压	最大电流	特殊	材料	颜色	UL		2m / 1m	5m / 2m	10m / 5m
	延长电缆 母头, 直型, M12	5, A	60V	4A		PUR	BK	•	CD-WAK5.022-L/S2800	8047517	8047518	8047519
	延长电缆 母头, 弯型, M12	5, A	60V	4A		PUR	BK	•	CD-WWAK5.022-L/S2800	8047520	8047521	8047522
	现场接线连接器 母头, 直型, M12 螺丝夹紧连接	5, A	125V	4A					WAKC5K	8004815		
	现场接线连接器 母头, 弯型, M12 螺丝夹紧连接	5, A	125V	4A					WWAKC5K	8004809		
	法兰 母头, 直型, M12 线芯连接 前面板安装 (不带固定螺丝)	5, A	60V	4A				•	CD-FVM12KUA5.022-0,5/M16	8085770		
	法兰 母头, 直型, M12 线芯连接 后面板安装 (带固定螺丝)	5, A	60V	4A				•	CD-FHM12KUA5.022-0,5/M16	8085771		
	延长电缆 公头, 直型, M12	5, A	60V	4A		PUR	BK	•	CD-WAS5.022-L/S2800	8047523	8047524	8047525
	延长电缆 公头, 弯型, M12	5, A	60V	4A		PUR	BK	•	CD-WWAS5.022-L/S2800	8047526	8047527	8047528
	现场接线连接器 公头, 直型, M12 螺丝夹紧连接	5, A	125V	4A					WASC5K	8004805		
	现场接线连接器 公头, 弯型, M12 螺丝夹紧连接	5, A	125V	4A					WWASC5K	8004807		
	法兰 公头, 直型, M12 线芯连接 前面板安装 (不带固定螺丝)	5, A	60V	4A				•	CD-FVM12SUA5.022-0,5/M16	8085772		
	法兰 公头, 直型, M12 线芯连接 后面板安装 (带固定螺丝)	5, A	60V	4A				•	CD-FHM12SUA5.022-0,5/M16	8085773		

标准连接器的长度:2米,5米,或10米。中继电缆长度:1米,2米或5米。法兰面板安装的电线长度:0.5米(0.2米)。其他电缆,电线长度可按照客户要求定制。

	顶端				电缆			UL	产品描述	L = 电缆长度*		
	针脚	最大电压	最大电流	特殊	材料	颜色	2m / 1m			5m / 2m	10m / 5m	
 连接电缆 母头, 直型, M12 公头, 直型, M12	5, A	60V	4A		PUR	BK	•	CD-WAK5.022-L-CD-WAS5.022/S2800	8047491	8047492	8047494	
 连接电缆 母头, 直型, M12 公头, 弯型, M12	5, A	60V	4A		PUR	BK	•	CD-WAK5.022-L-CD-WWAS5.022/S2800	8051938	8047532	8047533	
 连接电缆 母头, 弯型, M12 公头, 直型, M12	5, A	60V	4A		PUR	BK	•	CD-WWAK5.022-L-CD-WAS5.022/S2800	8051937	8047529	8047530	
 连接电缆 母头, 弯型, M12 公头, 弯型, M12	5, A	60V	4A		PUR	BK	•	CD-WWAK5.022-L-CD-WWAS5.022/S2800	8051939	8047535	8047536	
 终端插头 母头, 直型, M12	5, A	60V	4A				•	CD-WAK2.010-AK/S3234	8047942			
 终端插头 公头, 直型, M12	5, A	60V	4A				•	CD-WAS2.010-AS/S3234	8047943			
 T型分离器	5	60V	4A					FKM5-FKM5-FSM5/S222	8035172			

标准连接器的长度:2米,5米,或10米。中继电缆长度:1米,2米或5米。法兰面板安装的电线长度:0.5米(0.2米)。其他电缆,电线长度可按照客户要求定制。

对接连接器命名, 法兰

连接电缆

电源连接器命名

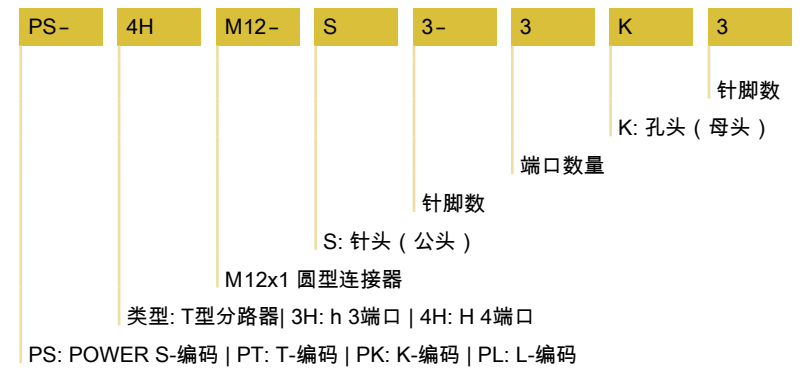
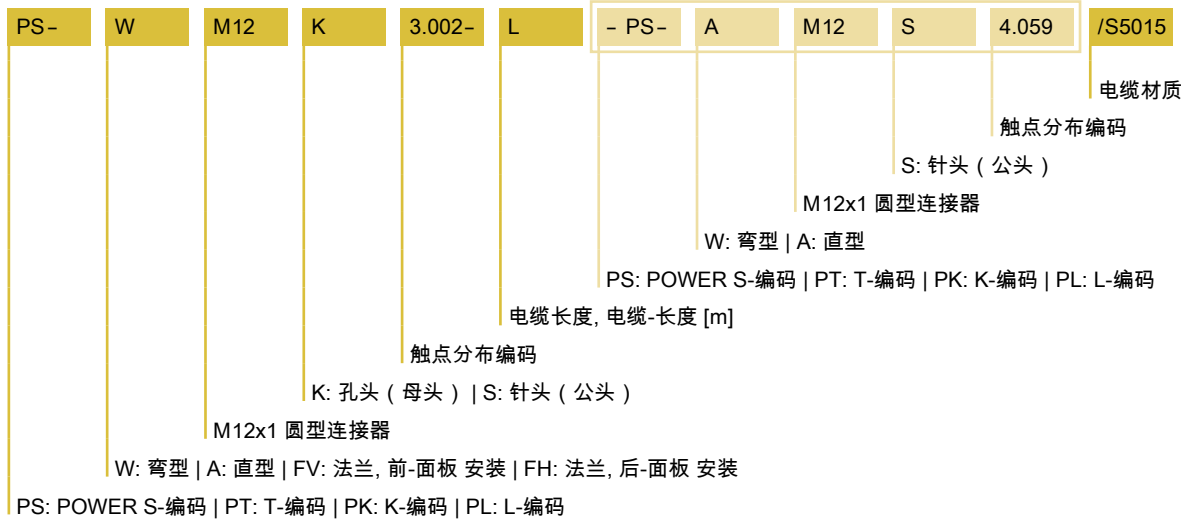

M12x1 POWER



电缆	材料	UL	颜色	特性	可适应拖链
S5015	PP/PUR	✓	BK	线芯横截面积 1,5mm <sup>2</sup>	✓
S5015GY	PP/PUR	✓	GY	线芯横截面积 1,5mm <sup>2</sup>	✓
S5025	PP/PUR	✓	BK	线芯横截面积 2,5mm <sup>2</sup>	✓
S5025GY	PP/PUR	✓	GY	线芯横截面积 2,5mm <sup>2</sup>	✓

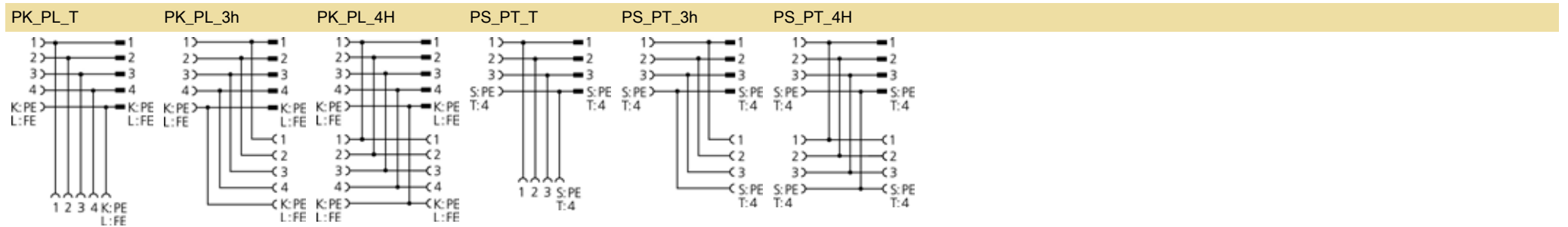

















## M12x1 POWER

技术参数	连接头	法兰连接	现场接线连接器	T型分离器, H通道分配器
绝缘电阻	≥10 <sup>8</sup> Ω	≥10 <sup>8</sup> Ω	≥10 <sup>8</sup> Ω	≥10 <sup>8</sup> Ω
电阻	≤ 5mΩ	≤ 5mΩ	≤ 3mΩ	≤ 5mΩ
产品环境温度	-30°C...+90°C	-40°C...+85°C	-40°C...+85°C	-30°C...+90°C
触点材料	合金, 铜锌, 镀金	合金, 镀金	合金, 镀金	合金, 镀金
触头载体材料	塑料, PA, 黑色	塑料, PA	塑料, PA	塑料, PA, 黑色
夹紧基体材料	塑料, TPU, 黑色	塑料, TPU	塑料, PA	塑料, TPU
连接螺母材料	合金, 铜锌, 镀镍	合金, 镀镍		合金, 镀镍
密封(母头)材料	FPM/FKM			
插座外壳材料		锌压铸, 镀镍		
标准	IEC 61076-2-111	IEC 61076-2-111	IEC 61076-2-111	IEC 61076-2-111
防护等级 (安装好)	IP65, IP67, IP68	IP65, IP67, IP68	IP67	IP65, IP67, IP68
机械寿命周期	>100 插拔次数	>100 插拔次数	>100 插拔次数	>100 插拔次数
污染等级	2	3	3	2
电缆出口			8...10mm	
连接横截面积			1,50mm <sup>2</sup>	









来自ESCHA的M12x1 POWER电源连接器代表着使用标准M12接口的可靠的电源传输。由于紧凑的插座设计, 带S编码 (630V, 12A), T编码 (630V, 12A), L编码 (63V, 16A, 4-FE遵守PNO准则不带FE) 和K编码 (630V, 12A, 4+PE) 设备尤其适用于自动化领域的电源供应。广泛的产品范围, 带有单端和双端的连接器以及H-、h-和T型连接器有利于现场的系列配线结构。我们所有M12x1的电源产品的连接导线横截面积高达2.5mm<sup>2</sup>是一项独特的特点。与小截面积的相比之下, 此特点促进了配电领域的巨大扩展, 特别是在直流配电-少量电压降的情况下。

		顶端				电缆		L = 电缆长度*			
		针脚	最大电压	最大电流	编码	材料	Ø[mm²]	产品描述	2m / 1m	5m / 2m	10m / 5m
	延长电缆 母头, 直型, M12	2+PE	630V <sub>AC</sub>   600V <sub>AC</sub> (UL)	12A	S	PUR   BK	3 x 1.5	PS-AM12K3.002-L/S5015	8064011	8064012	8064013
		3+PE	630V <sub>AC</sub>   600V <sub>AC</sub> (UL)	12A	S	PUR   BK	4 x 1.5	PS-AM12K4.155-L/S5015	8068091	8068092	8068093
	延长电缆 母头, 弯型, M12	2+PE	630V <sub>AC</sub>   600V <sub>AC</sub> (UL)	12A	S	PUR   BK	3 x 1.5	PS-WM12K3.002-L/S5015	8064014	8064015	8064016
		3+PE	630V <sub>AC</sub>   600V <sub>AC</sub> (UL)	12A	S	PUR   BK	4 x 1.5	PS-WM12K4.155-L/S5015	8068095	8068096	8068097
	延长电缆 公头, 直型, M12	2+PE	630V <sub>AC</sub>   600V <sub>AC</sub> (UL)	12A	S	PUR   BK	3 x 1.5	PS-AM12S3.002-L/S5015	8064017	8064018	8064019
		3+PE	630V <sub>AC</sub>   600V <sub>AC</sub> (UL)	12A	S	PUR   BK	4 x 1.5	PS-AM12S4.155-L/S5015	8068098	8068106	8068107
	延长电缆 公头, 弯型, M12	2+PE	630V <sub>AC</sub>   600V <sub>AC</sub> (UL)	12A	S	PUR   BK	3 x 1.5	PS-WM12S3.002-L/S5015	8064020	8064021	8064022
		3+PE	630V <sub>AC</sub>   600V <sub>AC</sub> (UL)	12A	S	PUR   BK	4 x 1.5	PS-WM12S4.155-L/S5015	8068108	8068109	8068110
	连接电缆 母头, 直型, M12	2+PE	630V <sub>AC</sub>   600V <sub>AC</sub> (UL)	12A	S	PUR   BK	3 x 1.5	PS-AM12K3.002-L-PS-AM12S3.002/S5015	8063999	8064000	8064001
		3+PE	630V <sub>AC</sub>   600V <sub>AC</sub> (UL)	12A	S	PUR   BK	4 x 1.5	PS-AM12K4.155-L-PS-AM12S4.155/S5015	8068297	8068131	8068132
	连接电缆 公头, 直型, M12	2+PE	630V <sub>AC</sub>   600V <sub>AC</sub> (UL)	12A	S	PUR   BK	3 x 1.5	PS-AM12K3.002-L-PS-WM12S3.002/S5015	8064002	8064003	8064004
		3+PE	630V <sub>AC</sub>   600V <sub>AC</sub> (UL)	12A	S	PUR   BK	4 x 1.5	PS-AM12K4.155-L-PS-WM12S4.155/S5015	8068298	8068134	8068135
	连接电缆 母头, 弯型, M12	2+PE	630V <sub>AC</sub>   600V <sub>AC</sub> (UL)	12A	S	PUR   BK	3 x 1.5	PS-AM12K3.002-L-PS-AM12S3.002/S5015	8064008	8064009	8064010
		3+PE	630V <sub>AC</sub>   600V <sub>AC</sub> (UL)	12A	S	PUR   BK	4 x 1.5	PS-AM12K4.155-L-PS-AM12S4.155/S5015	8068301	8068140	8068141
	连接电缆 公头, 弯型, M12	2+PE	630V <sub>AC</sub>   600V <sub>AC</sub> (UL)	12A	S	PUR   BK	3 x 1.5	PS-WM12K3.002-L-PS-WM12S3.002/S5015	8064005	8064006	8064007
		3+PE	630V <sub>AC</sub>   600V <sub>AC</sub> (UL)	12A	S	PUR   BK	4 x 1.5	PS-WM12K4.155-L-PS-WM12S4.155/S5015	8068299	8068137	8068138
	法兰 母头, 直型, M12 线芯连接 前面板安装 (不带固定螺丝)	2+PE	630V <sub>AC</sub>   600V <sub>AC</sub> (UL)	12A	S		3 x 1.5	PS-FVM12KU3.002-0,2/M16/S5015	8087076		
				12A	S		3 x 2.5	PS-FVM12KU3.002-0,2/M16/S5025	8086643		
		3+PE	630V <sub>AC</sub>   600V <sub>AC</sub> (UL)	12A	S		3 x 1.5	PS-FVM12KU4.155-0,2/M16/S5015	8087080		
				12A	S		4 x 2.5	PS-FVM12KU4.155-0,2/M16/S5025	8086188		

标准连接器的长度:2米,5米,或10米。中继电缆长度:1米,2米或5米。法兰面板安装的电线长度:0.5米(0.2米)。其他电缆,电线长度可按照客户要求定制。

	顶端				电缆		L = 电缆长度*			
	引脚	最大电压	最大电流	编码	材料	Ø[mm²]	产品描述	2m / 1m	5m / 2m	10m / 5m
	2+PE	630V <sub>AC</sub>   600V <sub>AC</sub> (UL)	12A	S		3 x 1.5	PS-FHM12KU3.002-0,2/M16/S5015	8087074		
			12A	S		3 x 2.5	PS-FHM12KU3.002-0,2/M16/S5025	8086182		
	3+PE	630V <sub>AC</sub>   600V <sub>AC</sub> (UL)	12A	S		4 x 1.5	PS-FHM12KU4.155-0,2/M16/S5015	8087078		
			12A	S		4 x 2.5	PS-FHM12KU4.155-0,2/M16/S5025	8086184		
	2+PE	630V <sub>AC</sub>   600V <sub>AC</sub> (UL)	12A	S		3 x 1.5	PS-FVM12SU3.002-0,2/M16/S5015	8087077		
			12A	S		3 x 2.5	PS-FVM12SU3.002-0,2/M16/S5025	8086644		
	3+PE	630V <sub>AC</sub>   600V <sub>AC</sub> (UL)	12A	S		4 x 1.5	PS-FVM12SU4.155-0,2/M16/S5015	8087081		
			12A	S		4 x 2.5	PS-FVM12SU4.155-0,2/M16/S5025	8086189		
	2+PE	630V <sub>AC</sub>   600V <sub>AC</sub> (UL)	12A	S		3 x 1.5	PS-FHM12SU3.002-0,2/M16/S5015	8087075		
			12A	S		3 x 2.5	PS-FHM12SU3.002-0,2/M16/S5025	8086183		
	3+PE	630V <sub>AC</sub>   600V <sub>AC</sub> (UL)	12A	S		4 x 1.5	PS-FHM12SU4.155-0,2/M16/S5015	8087079		
			12A	S		4 x 2.5	PS-FHM12SU4.155-0,2/M16/S5025	8086185		
	2+PE	630V <sub>AC</sub>   600V <sub>AC</sub> (UL)	12A	S			PS-FHM12KU3-P/M16	8086641		
	3+PE	630V <sub>AC</sub>   600V <sub>AC</sub> (UL)	12A	S			PS-FHM12KU4-P/M16	8086186		
	2+PE	630V <sub>AC</sub>   600V <sub>AC</sub> (UL)	12A	S			PS-FHM12SU3-P/M16	8086642		
	3+PE	630V <sub>AC</sub>   600V <sub>AC</sub> (UL)	12A	S			PS-FHM12SU4-P/M16	8086187		
	3+PE	630V <sub>DC</sub>	12A	S			PS-WAKC4K	8063400		
	3+PE	630V <sub>DC</sub>	12A	S			PS-WASC4K	8063399		
	3+PE	630V <sub>AC</sub>   600V <sub>AC</sub> (UL)	12A	S			PS-TM12-S4-2K4	8062858		
	3+PE	630V <sub>AC</sub>   600V <sub>AC</sub> (UL)	12A	S			PS-3HM12-S4-2K4	8062859		
	3+PE	630V <sub>AC</sub>   600V <sub>AC</sub> (UL)	12A	S			PS-4HM12-S4-3K4	8062860		

标准连接器的长度:2米,5米,或10米。中继电缆长度:1米,2米或5米。法兰面板安装的电缆长度:0.5米(0.2米)。其他电缆,电缆长度可按照客户要求定制。

		顶端				电缆		L = 电缆长度*		
		引脚	最大电压	最大电流	编码	材料	Ø[mm²]	产品描述	2m / 1m	5m / 2m
	延长电缆 母头, 直型, M12	4	63V <sub>DC</sub>	12A	T	PUR   BK 4 x 1.5	PT-AM12K4-L/S5015	8063986	8063987	8063988
				12A	T	PUR   BK 4 x 2.5	PT-AM12K4-L/S5025	8063962	8063963	8063964
	延长电缆 母头, 弯型, M12	4	63V <sub>DC</sub>	12A	T	PUR   BK 4 x 1.5	PT-WM12K4-L/S5015	8063989	8063990	8063991
				12A	T	PUR   BK 4 x 2.5	PT-WM12K4-L/S5025	8063965	8063966	8063967
	延长电缆 公头, 直型, M12	4	63V <sub>DC</sub>	12A	T	PUR   BK 4 x 1.5	PT-AM12S4-L/S5015	8063992	8063993	8063994
				12A	T	PUR   BK 4 x 2.5	PT-AM12S4-L/S5025	8063968	8063969	8063970
	延长电缆 公头, 弯型, M12	4	63V <sub>DC</sub>	12A	T	PUR   BK 4 x 1.5	PT-WM12S4-L/S5015	8063998	8063997	8063995
				12A	T	PUR   BK 4 x 2.5	PT-WM12S4-L/S5025	8063971	8063972	8063973
	连接电缆 母头, 直型, M12	4	63V <sub>DC</sub>	12A	T	PUR   BK 4 x 1.5	PT-AM12K4-L-PT-AM12S4/S5015	8063974	8063975	8063976
				12A	T	PUR   BK 4 x 2.5	PT-AM12K4-L-PT-AM12S4/S5025	8063950	8063951	8063952
	连接电缆 公头, 直型, M12	4	63V <sub>DC</sub>	12A	T	PUR   BK 4 x 1.5	PT-AM12K4-L-PT-WM12S4/S5015	8063977	8063978	8063979
				12A	T	PUR   BK 4 x 2.5	PT-AM12K4-L-PT-WM12S4/S5025	8063953	8063954	8063955
	连接电缆 母头, 弯型, M12	4	63V <sub>DC</sub>	12A	T	PUR   BK 4 x 1.5	PT-WM12K4-L-PT-AM12S4/S5015	8063983	8063984	8063985
				12A	T	PUR   BK 4 x 2.5	PT-WM12K4-L-PT-AM12S4/S5025	8063959	8063960	8063961
	连接电缆 公头, 弯型, M12	4	63V <sub>DC</sub>	12A	T	PUR   BK 4 x 1.5	PT-WM12K4-L-PT-WM12S4/S5015	8063980	8063981	8063982
				12A	T	PUR   BK 4 x 2.5	PT-WM12K4-L-PT-WM12S4/S5025	8063956	8063957	8063958
	法兰 母头, 直型, M12 线芯连接 前面板安装 (不带固定螺丝)	4	63V <sub>DC</sub>	12A	T	4 x 1.5	PT-FVM12KU4-0,2/M16/S5015	8087084		
				12A	T	4 x 2.5	PT-FVM12KU4-0,2/M16/S5025	8086194		

标准连接器的长度:2米,5米,或10米。中继电缆长度:1米,2米或5米。法兰面板安装的电线长度:0.5米(0.2米)。其他电缆,电线长度可按照客户要求定制。

		顶端				电缆		L = 电缆长度*			
		针脚	最大电压	最大电流	编码	材料	Ø[mm²]	产品描述	2m / 1m	5m / 2m	10m / 5m
	法兰母头, 直型, M12	4	63V <sub>DC</sub>	12A	T	4 x 1.5	PT-FHM12KU4-0,2/M16/S5015		8087082		
	线芯连接			12A	T				4 x 2.5	PT-FHM12KU4-0,2/M16/S5025	8086190
	法兰公头, 直型, M12	4	63V <sub>DC</sub>	12A	T	4 x 1.5	PT-FVM12SU4-0,2/M16/S5015		8087085		
	线芯连接			12A	T				4 x 2.5	PT-FVM12SU4-0,2/M16/S5025	8086195
	法兰公头, 直型, M12	4	63V <sub>DC</sub>	12A	T	4 x 1.5	PT-FHM12SU4-0,2/M16/S5015		8087083		
	线芯连接			12A	T				4 x 2.5	PT-FHM12SU4-0,2/M16/S5025	8086191
	法兰母头, 直型, M12 PC板-连接	4	63V <sub>DC</sub>	12A	T			PT-FHM12KU4-P/M16		8086192	
	法兰公头, 直型, M12 PC板-连接	4	63V <sub>DC</sub>	12A	T			PT-FHM12SU4-P/M16		8086193	
	现场接线连接器 母头, 直型, M12	4	63V <sub>DC</sub>	12A	T			PT-WAKC4K		8063398	
	现场接线连接器 公头, 直型, M12	4	63V <sub>DC</sub>	12A	T			PT-WASC4K		8063397	
	T型分离器	4	63V <sub>DC</sub>	12A	T			PT-TM12-S4-2K4		8067897	
	h型-分配器	4	63V <sub>DC</sub>	12A	T			PT-3HM12-S4-2K4		8067900	
	H型-分配器	4	63V <sub>DC</sub>	12A	T			PT-4HM12-S4-3K4		8067903	
	延长电缆 母头, 直型, M12	4+PE	630V <sub>AC</sub>   600V <sub>AC</sub> (UL)	12A	K	PUR   BK 5 x 1.5		PK-AM12K5.244-L/S5015	8075272	8075273	8075274











标准连接器的长度:2米,5米,或10米。中继电缆长度:1米,2米或5米。法兰面板安装的电线长度:0.5米(0.2米)。其他电缆,电线长度可按照客户要求定制。

		顶端				电缆		L = 电缆长度*			
		针脚	最大电压	最大电流	编码	材料	Ø[mm²]	产品描述	2m / 1m	5m / 2m	10m / 5m
	延长电缆 母头, 弯型, M12	4+PE	630V <sub>AC</sub>   600V <sub>AC</sub> (UL)	12A	K	PUR   BK	5 x 1.5	PK-WM12K5.244-L/S5015	8075298	8075299	8075300
	延长电缆 公头, 直型, M12	4+PE	630V <sub>AC</sub>   600V <sub>AC</sub> (UL)	12A	K	PUR   BK	5 x 1.5	PK-AM12S5.244-L/S5015	8075301	8075302	8075303
	延长电缆 公头, 弯型, M12	4+PE	630V <sub>AC</sub>   600V <sub>AC</sub> (UL)	12A	K	PUR   BK	5 x 1.5	PK-WM12S5.244-L/S5015	8075315	8075319	8075322
	连接电缆 母头, 直型, M12	4+PE	630V <sub>AC</sub>   600V <sub>AC</sub> (UL)	12A	K	PUR   BK	5 x 1.5	PK-AM12K5.244-L-PK-AM12S5.244/S5015	8075847	8075848	8075849
	公头, 直型, M12										
	连接电缆 母头, 直型, M12	4+PE	630V <sub>AC</sub>   600V <sub>AC</sub> (UL)	12A	K	PUR   BK	5 x 1.5	PK-AM12K5.244-L-PK-WM12S5.244/S5015	8076185	8076186	8076187
	公头, 弯型, M12										
	连接电缆 母头, 弯型, M12	4+PE	630V <sub>AC</sub>   600V <sub>AC</sub> (UL)	12A	K	PUR   BK	5 x 1.5	PK-WM12K5.244-L-PK-AM12S5.244/S5015	8076204	8076205	8076206
	公头, 直型, M12										
	连接电缆 母头, 弯型, M12	4+PE	630V <sub>AC</sub>   600V <sub>AC</sub> (UL)	12A	K	PUR   BK	5 x 1.5	PK-WM12K5.244-L-PK-WM12S5.244/S5015	8076195	8076196	8076197
	公头, 弯型, M12										
	法兰 母头, 直型, M12	4+PE	630V <sub>AC</sub>   600V <sub>AC</sub> (UL)	12A	K	5 x 1.5	PK-FVM12KU5.244-0,2/M16/S5015	8087065	8087065	8087065	
	线芯连接 前面板安装 (不带固定螺丝)			12A	K		5 x 2.5				PK-FVM12KU5.244-0,2/M16/S5025
	法兰 母头, 直型, M12	4+PE	630V <sub>AC</sub>   600V <sub>AC</sub> (UL)	12A	K	5 x 1.5	PK-FHM12KU5.244-0,2/M16/S5015	8087062	8087062	8087062	
	线芯连接 后面板安装 (带固定螺丝)			12A	K		5 x 2.5				PK-FHM12KU5.244-0,2/M16/S5025









标准连接器的长度: 2米, 5米, 或 10 米。中继电缆长度: 1米, 2米或 5米。法兰面板安装的电线长度: 0.5米 (0.2米)。其他电缆, 电线长度可按照客户要求定制。

		顶端				电缆		产品描述	L = 电缆长度*		
		针脚	最大电压	最大电流	编码	材料	Ø[mm²]		2m / 1m	5m / 2m	10m / 5m
	法兰 公头, 直型, M12 线芯连接 前面板安装 ( 不带固定螺丝 )	4+PE	630V <sub>AC</sub>   600V <sub>AC</sub> (UL)	12A	K	5 x 1.5	PK-FVM12SU5.244-0,2/M16/S5015	8087064			
				12A	K	5 x 2.5	PK-FVM12SU5.244-0,2/M16/S5025	8086174			
	法兰 公头, 直型, M12 线芯连接 后面板安装 ( 带固定螺丝 )	4+PE	630V <sub>AC</sub>   600V <sub>AC</sub> (UL)	12A	K	5 x 1.5	PK-FHM12SU5.244-0,2/M16/S5015	8087063			
				12A	K	5 x 2.5	PK-FHM12SU5.244-0,2/M16/S5025	8086170			
	法兰 母头, 直型, M12 PC板-连接 后面板安装 ( 带固定螺丝 )	4+PE	630V <sub>AC</sub>   600V <sub>AC</sub> (UL)	12A	K		PK-FHM12KU5-P/M16	8086171			
	法兰 公头, 直型, M12 PC板-连接 后面板安装 ( 带固定螺丝 )	4+PE	630V <sub>AC</sub>   600V <sub>AC</sub> (UL)	12A	K		PK-FHM12SU5-P/M16	8086172			
	现场接线连接器 母头, 直型, M12 螺丝夹紧连接	5	630V <sub>DC</sub>	12A	K		PK-WAKC5K	8086298			
	现场接线连接器 公头, 直型, M12 螺丝夹紧连接	5	630V <sub>DC</sub>	12A	K		PK-WASC5K	8086297			
	T型分离器	4+PE	500V <sub>AC</sub>	12A	K		PK-TM12-S5-2K5	8075810			
	h型-分配器	4+PE	500V <sub>AC</sub>	12A	K		PK-3HM12-S5-2K5	8075817			
	H型-分配器	4+PE	500V <sub>AC</sub>	12A	K		PK-4HM12-S5-3K5	8075818			
	延长电缆 母头, 直型, M12	4	63V <sub>DC</sub>	16A	L	PUR   BK 4 x 1.5	PL-AM12K4-L/S5015	8076483	8076484	8076523	
				16A	L	PUR   BK 4 x 2.5	PL-AM12K4-L/S5025	8076486	8076487	8076524	
		4+FE	63V <sub>DC</sub>	16A	L	PUR   GY 5 x 1.5	PL-AM12K5.269-L/S5015GY	8075323	8075324	8075325	
				16A	L	PUR   GY 5 x 2.5	PL-AM12K5.269-L/S5025GY	8075257	8075258	8075260	



标准连接器的长度:2米,5米,或10米。中继电缆长度:1米,2米或5米。法兰面板安装的电线长度:0.5米(0.2米)。其他电缆,电线长度可按照客户要求定制。

		顶端			电缆		L = 电缆长度*				
		针脚	最大电压	最大电流	编码	材料	Ø[mm²]	产品描述	2m / 1m	5m / 2m	10m / 5m
	延长电缆 母头, 弯型, M12	4	63V <sub>DC</sub>	16A	L	PUR   BK	4 x 1.5	PL-WM12K4-L/S5015	8076489	8076490	8076525
				16A	L	PUR   BK	4 x 2.5	PL-WM12K4-L/S5025	8076492	8076493	8076526
		4+FE	63V <sub>DC</sub>	16A	L	PUR   GY	5 x 1.5	PL-WM12K5.269-L/S5015GY	8075326	8075327	8075328
				16A	L	PUR   GY	5 x 2.5	PL-WM12K5.269-L/S5025GY	8075261	8075262	8075263
	延长电缆 公头, 直型, M12	4	63V <sub>DC</sub>	16A	L	PUR   BK	4 x 1.5	PL-AM12S4-L/S5015	8076495	8076496	8076527
				16A	L	PUR   BK	4 x 2.5	PL-AM12S4-L/S5025	8076498	8076499	8076528
		4+FE	63V <sub>DC</sub>	16A	L	PUR   GY	5 x 1.5	PL-AM12S5.269-L/S5015GY	8075329	8075330	8075331
				16A	L	PUR   GY	5 x 2.5	PL-AM12S5.269-L/S5025GY	8075264	8075265	8075266
	延长电缆 公头, 弯型, M12	4	63V <sub>DC</sub>	16A	L	PUR   BK	4 x 1.5	PL-WM12S4-L/S5015	8076501	8076502	8076529
				16A	L	PUR   BK	4 x 2.5	PL-WM12S4-L/S5025	8076504	8076505	8076530
		4+FE	63V <sub>DC</sub>	16A	L	PUR   GY	5 x 1.5	PL-WM12S5.269-L/S5015GY	8075333	8075334	8075335
				16A	L	PUR   GY	5 x 2.5	PL-WM12S5.269-L/S5025GY	8075267	8075268	8075269
 	连接电缆 母头, 直型, M12 公头, 直型, M12	4	63V <sub>DC</sub>	16A	L	PUR   BK	4 x 1.5	PL-AM12K4-L-PL-AM12S4/S5015	8076457	8076458	8076459
				16A	L	PUR   BK	4 x 2.5	PL-AM12K4-L-PL-AM12S4/S5025	8076460	8076461	8076462
		4+FE	63V <sub>DC</sub>	16A	L	PUR   GY	5 x 1.5	PL-AM12K5.269-L-PL-AM12S5.269/S5015GY	8076179	8076180	8076181
				16A	L	PUR   GY	5 x 2.5	PL-AM12K5.269-L-PL-AM12S5.269/S5025GY	8076183	8076182	8076184
 	连接电缆 母头, 直型, M12 公头, 弯型, M12	4	63V <sub>DC</sub>	16A	L	PUR   BK	4 x 1.5	PL-AM12K4-L-PL-WM12S4/S5015	8076463	8076464	8076465
				16A	L	PUR   BK	4 x 2.5	PL-AM12K4-L-PL-WM12S4/S5025	8076466	8076467	8076468
		4+FE	63V <sub>DC</sub>	16A	L	PUR   GY	5 x 1.5	PL-AM12K5.269-L-PL-WM12S5.269/S5015GY	8076188	8076189	8076190
				16A	L	PUR   GY	5 x 2.5	PL-AM12K5.269-L-PL-WM12S5.269/S5025GY	8076192	8076193	8076194
 	连接电缆 母头, 弯型, M12 公头, 直型, M12	4	63V <sub>DC</sub>	16A	L	PUR   BK	4 x 1.5	PL-WM12K4-L-PL-AM12S4/S5015	8076478	8076476	8076477
				16A	L	PUR   BK	4 x 2.5	PL-WM12K4-L-PL-AM12S4/S5025	8076479	8076480	8076481
		4+FE	63V <sub>DC</sub>	16A	L	PUR   GY	5 x 1.5	PL-WM12K5.269-L-PL-AM12S5.269/S5015GY	8076207	8076208	8076209
				16A	L	PUR   GY	5 x 2.5	PL-WM12K5.269-L-PL-AM12S5.269/S5025GY	8076210	8076211	8076212
 	连接电缆 母头, 弯型, M12 公头, 弯型, M12	4	63V <sub>DC</sub>	16A	L	PUR   BK	4 x 1.5	PL-WM12K4-L-PL-WM12S4/S5015	8076469	8076470	8076471
				16A	L	PUR   BK	4 x 2.5	PL-WM12K4-L-PL-WM12S4/S5025	8076472	8076473	8076475
		4+FE	63V <sub>DC</sub>	16A	L	PUR   GY	5 x 1.5	PL-WM12K5.269-L-PL-WM12S5.269/S5015GY	8076198	8076199	8076200
				16A	L	PUR   GY	5 x 2.5	PL-WM12K5.269-L-PL-WM12S5.269/S5025GY	8076201	8076202	8076203



		顶端				电缆		产品描述	L = 电缆长度*		
		引脚	最大电压	最大电流	编码	材料	Ø[mm²]		2m / 1m	5m / 2m	10m / 5m
	法兰 母头, 直型, M12 线芯连接 前面板安装 (不带固定螺丝)	4	63V <sub>DC</sub>	12A	L		4 x 1.5	PL-FVM12KU4-0,2/M16/S5015	8087068		
				16A	L		4 x 2.5	PL-FVM12KU4-0,2/M16/S5025	8086638		
		4+FE	63V <sub>DC</sub>	16A	L		5 x 1.5	PL-FVM12KU5.269-0,2/M16/S5015	8087073		
				16A	L		5 x 2.5	PL-FVM12KU5.269-0,2/M16/S5025	8086180		
	法兰 母头, 直型, M12 线芯连接 后面板安装 (带固定螺丝)	4	63V <sub>DC</sub>	12A	L		4 x 1.5	PL-FHM12KU4-0,2/M16/S5015	8087066		
				16A	L		4 x 2.5	PL-FHM12KU4-0,2/M16/S5025	8086175		
		4+FE	63V <sub>DC</sub>	16A	L		5 x 1.5	PL-FHM12KU5.269-0,2/M16/S5015	8087070		
				16A	L		5 x 2.5	PL-FHM12KU5.269-0,2/M16/S5025	8086177		
	法兰 公头, 直型, M12 线芯连接 前面板安装 (不带固定螺丝)	4	63V <sub>DC</sub>	12A	L		4 x 1.5	PL-FVM12SU4-0,2/M16/S5015	8087069		
				16A	L		4 x 2.5	PL-FVM12SU4-0,2/M16/S5025	8086639		
		4+FE	63V <sub>DC</sub>	16A	L		5 x 1.5	PL-FVM12SU5.269-0,2/M16/S5015	8087072		
				16A	L		5 x 2.5	PL-FVM12SU5.269-0,2/M16/S5025	8086181		
	法兰 公头, 直型, M12 线芯连接 后面板安装 (带固定螺丝)	4	63V <sub>DC</sub>	12A	L		4 x 1.5	PL-FHM12SU4-0,2/M16/S5015	8087067		
				16A	L		4 x 2.5	PL-FHM12SU4-0,2/M16/S5025	8086176		
		4+FE	63V <sub>DC</sub>	16A	L		5 x 1.5	PL-FHM12SU5.269-0,2/M16/S5015	8087071		
				16A	L		5 x 2.5	PL-FHM12SU5.269-0,2/M16/S5025	8086178		
	法兰 母头, 直型, M12 PC板-连接 后面板安装 (带固定螺丝)	4	63V <sub>DC</sub>	16A	L			PL-FHM12KU4-P/M16	8086636		
		4+FE	63V <sub>DC</sub>	16A	L			PL-FHM12KU5-P/M16	8086640		
	法兰 公头, 直型, M12 PC板-连接 后面板安装 (带固定螺丝)	4	63V <sub>DC</sub>	16A	L			PL-FHM12SU4-P/M16	8086637		
		4+FE	63V <sub>DC</sub>	16A	L			PL-FHM12SU5-P/M16	8086179		
	现场接线连接器 母头, 直型, M12 螺丝夹紧连接	5	63V <sub>DC</sub>	16A	L			PL-WAKC5K	8086300		
	现场接线连接器 公头, 直型, M12 螺丝夹紧连接	5	63V <sub>DC</sub>	16A	L			PL-WASC5K	8086299		
	T型分离器	5	63V <sub>DC</sub>	16A	L			PL-TM12-S5-2K5	8075819		

标准连接器的长度:2米,5米,或10米。中继电缆长度:1米,2米或5米。法兰面板安装的电线长度:0.5米(0.2米)。其他电缆,电线长度可按照客户要求定制。

		顶端				电缆		L = 电缆长度*			
		针脚	最大电压	最大电流	编码	材料	Ø[mm²]	产品描述	2m / 1m	5m / 2m	10m / 5m
	h型-分配器	5	63V <sub>DC</sub>	16A	L			PL-3HM12-S5-2K5	8075820		
	H型-分配器	5	63V <sub>DC</sub>	16A	L			PL-4HM12-S5-3K5	8075821		



## 2路分路器带相同端口命名

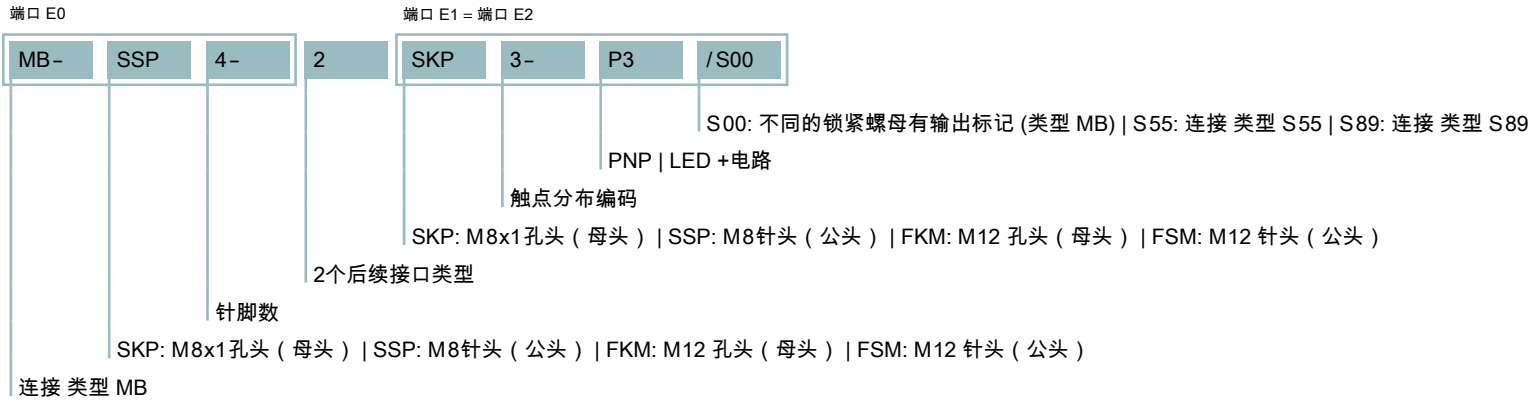

## 2路分路器带不同端口命名





T型 屏蔽



Y



S89



MB\_M12



Y\_M12 屏蔽



MB\_M8











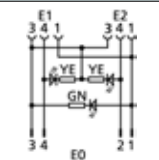

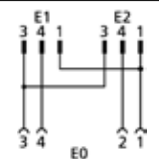

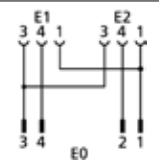

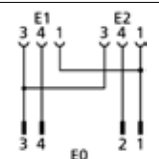

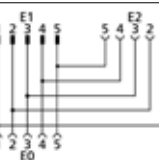

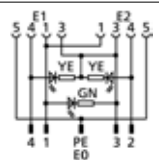
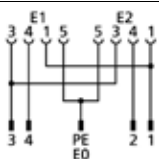



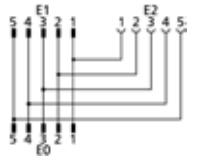

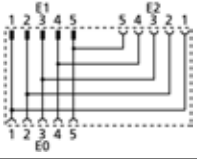

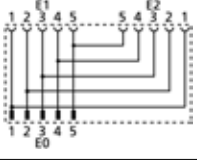
S56

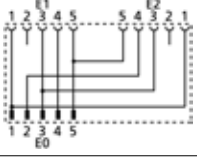

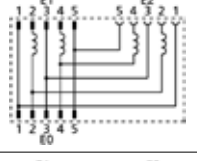

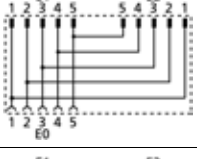

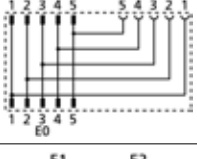

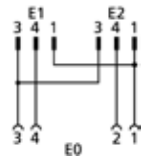

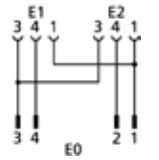

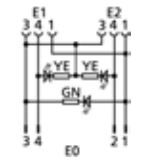
### T型分离器 | Y型分离器

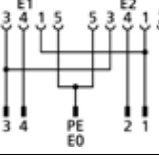
技术参数	Y型分离器	T型分离器	转接器	直通穿墙式
绝缘电阻	≥10 <sup>9</sup> Ω	≥10 <sup>9</sup> Ω	≥10 <sup>9</sup> Ω	≥10 <sup>9</sup> Ω
产品环境温度	-30°C...+90°C	-30°C...+90°C	-30°C...+90°C	-25°C...+85°C
触点材料	合金, 镀金	合金, 镀金	合金	合金, 镀金
触头载体材料	塑料, TPU	塑料, TPU	塑料, PA	塑料
夹紧基体材料	塑料, TPU	塑料, TPU	塑料, TPU	
密封(母头)材料	塑料, TPU	FPM/FKM	塑料, TPU	
标准	IEC 61076-2-101/-104	IEC 61076-2-101		IEC 61076-2-101
防护等级 (安装好)	IP65, IP67, IP68	IP65, IP67, IP68	IP65, IP67, IP68	IP67
机械寿命周期	>100 插拔次数	>100 插拔次数	>100 插拔次数	>100 插拔次数
污染等级	3	3	3	3 (RJ45:2)

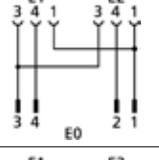
用我们Y型和T型分配器你可以很容易地设立分支。信号可以直接被分成两路。接口(公头或母头)可安排成多种配置,这给你带来更多多样性和易变性。根据要求,可以提供屏蔽分配方案用在PROFIBUS和CANopen通信应用上。

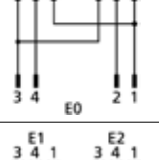
			端口						
			E0	E1	E2	最大电压	最大电流	产品描述	物料编号
		Y型分离器 M12 S89	公头, M12, 带LED 4 针脚, A	母头, M12, 带LED 3 针脚, A	母头, M12, 带LED 3 针脚, A	30V	4A	FSM4-2FKM3P3/S89	8012652
		Y型分离器 M12 S89	母头, M12 4 针脚, A	公头, M12 3 针脚, A	公头, M12 3 针脚, A	250V	4A	FKM4-2FSM3/S89	8012651
		Y型分离器 M12 S89	公头, M12 4 针脚, A	母头, M12 3 针脚, A	母头, M12 3 针脚, A	250V	4A	FSM4-2FKM3/S89	8010464
			公头, M12 5 针脚, A	母头, M12 5 针脚, A	母头, M12 5 针脚, A	60V	4A	FSM5-2FKM5.4/S89	8010471
		Y型分离器 M12 M8 - M8 S89	公头, M12 4 针脚, A	母头, M8 3 针脚	母头, M8 3 针脚	60V	4A	FSM4-2SKP3/S89	8013058
		Y型分离器 M12 MB	母头, M12 5 针脚, A	公头, M12 5 针脚, A	母头, M12 5 针脚, A	60V	4A	MB-FKM5-FSM5-FKM5	8024976
		Y型分离器 M12 MB	公头, M12, 带LED 5 针脚, A	母头, M12, 带LED 5 针脚, A	母头, M12, 带LED 5 针脚, A	30V	4A	MB-FSM5-2FKM5.4P3	8024644
		Y型分离器 M12 MB	公头, M12 5 针脚, A	母头, M12 5 针脚, A	母头, M12 5 针脚, A	60V	4A	MB-FSM5-2FKM5.4	8024643
			公头, M12 8 针脚, A	母头, M12 8 针脚, A	母头, M12 8 针脚, A	60V	2A	MB-FSM8-2FKM8	8028876
			公头, M12 5 针脚, A	母头, M12 5 针脚, A	母头, M12 5 针脚, A	60V	4A	MB-FSM5.4-2FKM5.4/S1927	8027501

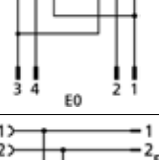

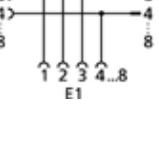







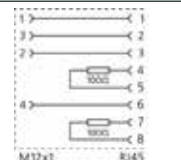

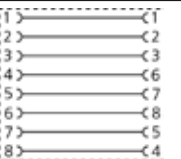
			端口						
			E0	E1	E2	最大电压	最大电流	产品描述	物料编号
		Y型分离器 M12 MB	公头, M12 5 针脚, A	公头, M12 5 针脚, A	母头, M12 5 针脚, A	60V	4A	MB-FSM5-FSM5-FKM5	8044611
		Y型分离器 M12  屏蔽	母头, M12 5 针脚, A	公头, M12 5 针脚, A	母头, M12 5 针脚, A	60V	4A	Y-WAKS5-WASS5-WAKS5	8057723
		Y型分离器 M12  屏蔽	公头, M12 5 针脚, A	母头, M12 5 针脚, A	母头, M12 5 针脚, A	60V	4A	Y-WASS5-2WAKS5	8056694
			公头, M12 8 针脚, A	母头, M12 8 针脚, A	母头, M12 8 针脚, A	30V	2A	Y-WASS8-2WAKS8	8057725
		Y型分离器 M12  屏蔽	公头, M12 5 针脚, A	母头, M12 5 针脚, A	母头, M12 5 针脚, A	60V	4A	Y-WASS5-2WAKS5.4	8062356
		Y型分离器 Profibus M12 屏蔽	公头, M12 5 针脚, B	公头, M12 5 针脚, B	母头, M12 5 针脚, B	60V	0.4A	PB-Y-WASSW5-WASSW5-WAKSW5	8057724
		Y型分离器 M12  屏蔽	母头, M12 5 针脚, A	公头, M12 5 针脚, A	公头, M12 5 针脚, A	30V	4A	Y-WAKS5-2WASS5	8057722
		Y型分离器 M12  屏蔽	公头, M12 5 针脚, A	公头, M12 5 针脚, A	母头, M12 5 针脚, A	60V	4A	Y-WASS5-WASS5-WAKS5	8057721
		Y型分离器 M12 Ø8mm快插 - Ø8mm 快插	母头, M12 4 针脚, A	公头, Ø8mm快插 3 针脚	公头, Ø8mm快插 3 针脚	60V	4A	FKM4-2ESP3S	8008080

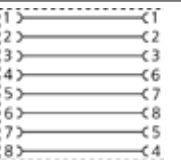
			端口						
			E0	E1	E2	最大电压	最大电流	产品描述	物料编号
		Y型分离器 M8 MB	公头, M8 4 针脚	母头, M8 3 针脚	母头, M8 3 针脚	60V	4A	MB-SSP4-2SKP3/S56	8052222
			公头, M8 3 针脚	母头, M8 3 针脚	母头, M8 3 针脚	60V	4A	MB-SSP3-2SKP3-2xAND	8083105
			公头, M8 3 针脚	母头, M8 3 针脚	母头, M8 3 针脚	60V	4A	MB-SSP3-2SKP3	8096527
		Y型分离器 M8 MB	公头, M8, 带LED 4 针脚	母头, M8, 带LED 3 针脚	母头, M8, 带LED 3 针脚	30V	4A	MB-SSP4-2SKP3P3/S56	8052223
		Y型分离器 M12 S55	公头, M12 5 针脚, A	母头, M12 5 针脚, A	母头, M12 5 针脚, A	60V	4A	FSM5-2FKM5.4/S55	8018720
		Y型分离器 M12 M8 - M8 S55	公头, M12 4 针脚, A	母头, M8 3 针脚	母头, M8 3 针脚	60V	4A	FSM4-2SKP3/S55/S56	8052224
		Y型分离器 M12 M8 - M8	公头, M12 4 针脚, A	母头, M8 3 针脚	母头, M8 3 针脚	60V	4A	FSM4-2SKP3	8008081
		Y型分离器 M8/Ø8mm 快插 M8 - M8	公头, M8/Ø8mm 快插 4 针脚	母头, M8 3 针脚	母头, M8 3 针脚	60V	4A	SESP4S-2SKP3	8008082
		T型分离器 M12	母头, M12 4 针脚, A	母头, M12 4 针脚, A	公头, M12 4 针脚, A	250V	4A	FKM4-FKM4-FSM4	8009675
			母头, M12 5 针脚, A	母头, M12 5 针脚, A	公头, M12 5 针脚, A	60V	4A	FKM5-FKM5-FSM5	8011661
			母头, M12 8 针脚, A	母头, M12 8 针脚, A	公头, M12 8 针脚, A	30V	2A	FKM8-FKM8-FSM8	8038856

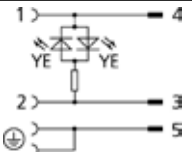

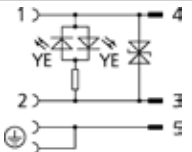
			端口						
			E0	E1	E2	最大电压	最大电流	产品描述	物料编号
		T型分离器 M12	母头, M12 4 针脚, A	公头, M12 4 针脚, A	公头, M12 4 针脚, A	250V	4A	FKM4-FSM4-FSM4	8008139
			母头, M12 5 针脚, A	公头, M12 5 针脚, A	公头, M12 5 针脚, A	60V	4A	FKM5-FSM5-FSM5	8017792
		T型分离器 CANopen/DeviceNet M12	母头, M12 5 针脚, A	母头, M12 5 针脚, A	公头, M12 5 针脚, A	60V	4A	FKM5-FKM5-FSM5/S222	8035172
		T型分离器 M12	母头, M12 4 针脚, A	母头, M12 4 针脚, A	公头, M12 4 针脚, A	250V	4A	T-WAKS4-WAKS4-WASS4	8060493
		屏蔽	母头, M12 5 针脚, A	母头, M12 5 针脚, A	公头, M12 5 针脚, A	60V	4A	T-WAKS5-WAKS5-WASS5	8056693
			母头, M12 8 针脚, A	母头, M12 8 针脚, A	公头, M12 8 针脚, A	30V	2A	T-WAKS8-WAKS8-WASS8	8057720
		T型分离器 M12  屏蔽	母头, M12 5 针脚, A	公头, M12 5 针脚, A	公头, M12 5 针脚, A	60V	4A	T-WAKS5-WASS5-WASS5	8057718
		T型分离器 Profibus M12 屏蔽	母头, M12 5 针脚, B	公头, M12 5 针脚, B	公头, M12 5 针脚, B	60V	0.4A	PB-T-WAKSW5-WASSW5-WASSW5	8057719
		转接器 M12 - M12	母头, M12 5 针脚, A	母头, M12 5 针脚, A		60V	4A	WAK4.5-WAK4.5	8041351
		转接器 M12 - M12	母头, M12 5 针脚, A	公头, M12 5 针脚, A		60V	4A	WAK4.5-WAS4.5	8041349

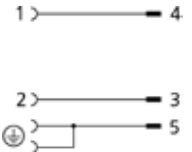
			端口						
			E0	E1	E2	最大电压	最大电流	产品描述	物料编号
		转接器 M12 - M12	公头, M12 5 针脚, A	公头, M12 5 针脚, A		60V	4A	WAS4.5-WAS4.5	8041352
		转接器 M12 - M8	公头, M12 3 针脚, A	母头, M8 3 针脚		60V	4A	FSM3-SKP3	8008079
			公头, M12 4 针脚, A	母头, M8 4 针脚		60V	4A	FSM4-SKP4	8008138
		直通穿墙式 M12 - M12	母头, 直型, M12 4 针脚, A	公头, 直型, M12 4 针脚, A		250V	4A	FKFS4/M12	8018404
			母头, 直型, M12 5 针脚, A	公头, 直型, M12 5 针脚, A		60V	4A	FKFS4.5/M12	8018405
			母头, 直型, M12 8 针脚, A	公头, 直型, M12 8 针脚, A		30V	2A	FKFS8/M12	8018410
		转接器 工业以太网 M12 - M12 屏蔽	母头, 直型, M12 4 针脚, D	母头, 直型, M12 4 针脚, D		250V	4A	IE-WAKSY4-IE-WAKSY4	8065952
		转接器 工业以太网 M12 - M12 屏蔽	母头, 直型, M12 8 针脚, X	母头, 直型, M12 8 针脚, X		50V <sub>AC</sub>   60V <sub>DC</sub>	0.5A	IE-WAKSX8-IE-WAKSX8	8065951
		转接器 工业以太网 M12 - M12 屏蔽	母头, 直型, M12 8 针脚, X	母头, 直型, M12 4 针脚, D		50V <sub>AC</sub>   60V <sub>DC</sub>	0.5A	IE-WAKSX8-IE-WAKSY4	8065950
		直通穿墙式 工业以太网 M12 - RJ 45 屏蔽	母头, 直型, M12 4 针脚, D	母头, 直型, RJ45 8 针脚		50V <sub>AC/DC</sub>	0.2A	IE-FKFDSY4-RJ45KS	8069793

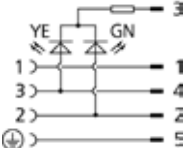
			端口						
			E0	E1	E2	最大电压	最大电流	产品描述	物料编号
		直通穿墙式 工业以太网 M12 - RJ 45 屏蔽	母头, 弯型, M12 4 针脚, D	母头, 直型, RJ45 8 针脚		50V <sub>AC/DC</sub>	0.2A	IE-WFKFDSY4-RJ45KS	8069794
		直通穿墙式 工业以太网 M12 - RJ 45 屏蔽	母头, 直型, M12 8 针脚, X	母头, 直型, RJ45 8 针脚		50V <sub>AC</sub>   60V <sub>DC</sub>	0.5A	IE-FKFDSX8-RJ45KS	8055773
		直通穿墙式 工业以太网 M12 - RJ 45 屏蔽	母头, 弯型, M12 8 针脚, X	母头, 直型, RJ45 8 针脚		50V <sub>AC</sub>   60V <sub>DC</sub>	0.5A	IE-WFKFDSX8-RJ45KS	8055774
		转接器 阀 M12	公头, 弯型, A阀	M12, 5针脚 A		24V <sub>AC/DC</sub>	4A	VA22-24.1-WAS5.002	8055767
		转接器 阀 M12	公头, 弯型, A阀	M12, 5针脚 A		24V <sub>AC/DC</sub>	4A	VA22-24.3-WAS5.002	8055768
		转接器 阀 M12	公头, 弯型, A阀	M12, 5针脚 A		60V <sub>AC/DC</sub>	4A	VA22-60.0-WAS5.002	8055770
		转接器 阀 M12	公头, 弯型, A阀	M12, 5针脚 A		24V <sub>DC</sub>	4A	VA41-24.2-WAS5	8055769

命名

预注连接器接口类型 (出口E1 + 出口E2)

YK-	FK	4	M8-	2	AL-	SW	KP	3	P2/	L/	L/	S370
-----	----	---	-----	---	-----	----	----	---	-----	----	----	------

电缆材质  
 电缆长度 出口E2  
 电缆长度 出口E1  
 PNP | LED + 电路  
 通道  
 M8 KP: 孔头 | SP: 针头  
 M12 WAK: 孔头 | WAS: 针头  
 M8 SW: 可拧紧, 弯型 | S: 可拧紧, 直型  
 M12 W: 弯型 | 无: 直型  
 Automation Line 自动化工业  
 2个后续接口类型 (出口E1 + 出口E2)  
 类型: M8 | M12  
 通道E0针脚数  
 FK: 法兰-母头 | FS: 法兰-公头  
 带电缆出口的分线系统

预注连接器接口类型 (出口E1 + 出口E2)

2	V	A	22	24.	3
---	---	---	----	-----	---

接线 LED  
 3: +抑制二极管  
 4: +齐纳二极管  
 U<sub>[max]</sub>: 24VDC | 24VAC/DC  
 触点 21: 2+PE  
 22: 2+PE 跳线  
 类型: A | B | BI | C | CI  
 阀连接器  
 2个后续接口类型 (出口E1 + 出口E2)



电缆	材料	UL	颜色	特性	可适应拖链	抗扭	抗焊接火花
P00	PVC/PVC		GY				
S370	PUR/PP	✓	BK		✓	✓	✓
S7400	PUR/PP	✓	OG	机器人, 高机械应力	✓	✓	✓

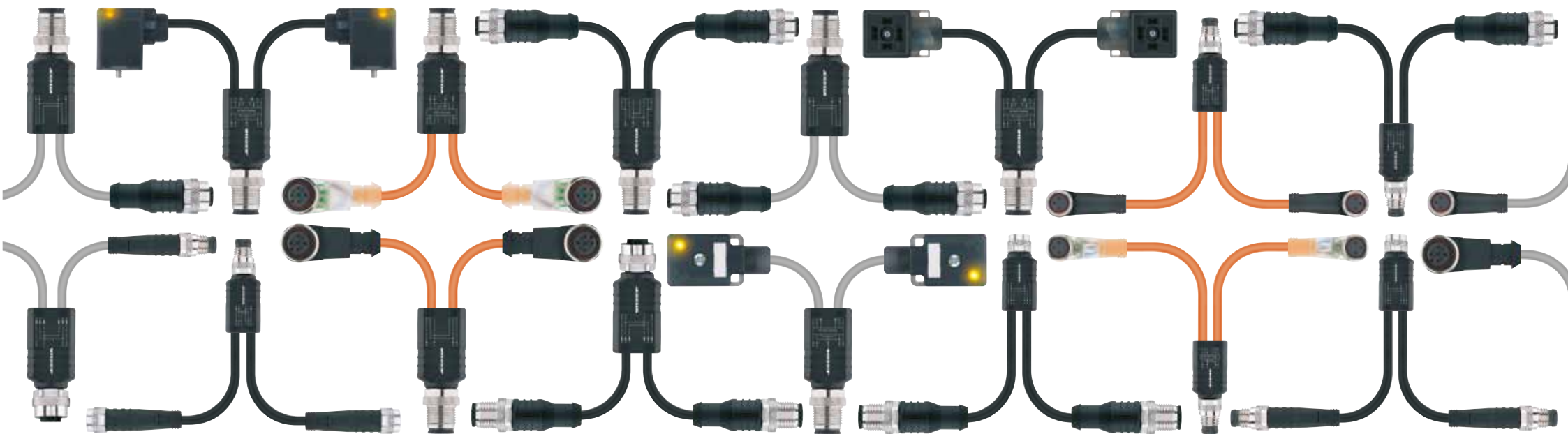







## Y型分离器 使用电缆出口

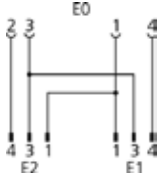

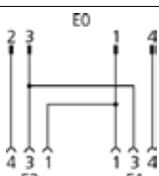



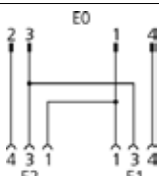

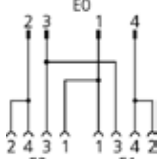

技术参数	M12	M8	阀
绝缘电阻	≥10 <sup>8</sup> Ω	≥10 <sup>8</sup> Ω	≥10 <sup>8</sup> Ω
产品环境温度	-30°C...+90°C	-30°C...+90°C	-30°C...+90°C
触点材料	合金, 镀金	合金, 镀金	合金, 镀银
触头载体材料	塑料, TPU	塑料, TPU	塑料, PA, 黑色
夹紧基体材料	塑料, TPU	塑料, TPU	塑料, TPU
连接螺母材料	合金, 镀镍	合金, 镀镍	
密封(母头)材料	FPM/FKM	FPM/FKM	塑料, TPU
标准	IEC 61076-2-101	IEC 61076-2-104	DIN EN 175301-803
防护等级 ( 安装好 )	IP65, IP67, IP68	IP65, IP67, IP68	IP65, IP67, IP68
机械寿命周期	>100 插拔次数	>100 插拔次数	>100 插拔次数
污染等级	3	3	3

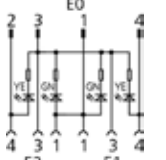
非常紧凑带电缆的Y型转接头可用在M8 和 M12插座型号上。公头和母头的排列可由客户自由选择。所有PUR和PVC的标准电缆都可用在电缆出口。这些电缆出口都可按要求配M8-, M12-或阀连接器。由于不同选项, 此高多样性几乎可以为任何应用方便产品配置。

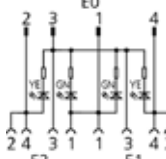

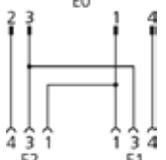
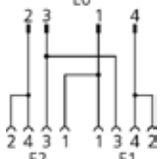

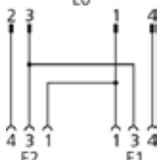





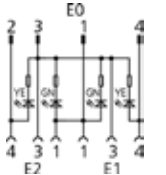

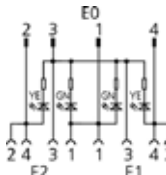
L = 电缆长度

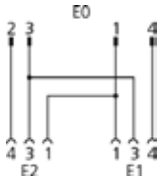
		E0	E1 + E2	电缆	产品描述	0,3m	0,6m	1m	2m	3m	5m	10m
		母头, M12, 直型 4 针脚, A	开放式线缆端口	PVC	YK-FK4M12-L/L/P00				8075696		8075697	8075698
				PUR	YK-FK4M12-L/L/S370				8075693		8075694	8075695
				PUR	YK-FK4M12-L/L/S7400				8075699		8075700	8075701
		母头, M12, 直型 4 针脚, A	公头, M12, 直型 3 针脚, A	PVC	YK-FK4M12-2AL-WAS3-L/L/P00	8075999	8076005	8076011	8076014	8076018	8076021	
				PUR	YK-FK4M12-2AL-WAS3-L/L/S370	8075930	8075937	8075942	8075944	8075946	8075948	
				PUR	YK-FK4M12-2AL-WAS3-L/L/S7400	8076028	8076030	8076034	8076041	8076083	8076087	
		母头, M12, 直型 4 针脚, A	公头, M8, 直型 3 针脚, A	PVC	YK-FK4M12-2AL-SSP3-L/L/P00	8075902	8075903	8075904	8075905	8075906	8075907	
				PUR	YK-FK4M12-2AL-SSP3-L/L/S370	8075852	8075890	8075891	8075892	8075893	8075894	
				PUR	YK-FK4M12-2AL-SSP3-L/L/S7400	8075908	8075909	8075910	8075922	8075925	8075927	
		公头, M12, 直型 4 针脚, A	开放式线缆端口	PVC	YK-FS4M12-L/L/P00				8075705		8075706	8075707
				PUR	YK-FS4M12-L/L/S370				8075702		8075703	8075704
				PUR	YK-FS4M12-L/L/S7400				8075708		8075709	8075710
		公头, M12, 直型 4 针脚, A	母头, M12, 直型 3 针脚, A	PVC	YK-FS4M12-2AL-WAK3-L/L/P00	8075968	8075969	8075970	8075971	8075973	8075979	
				PUR	YK-FS4M12-2AL-WAK3-L/L/S370	8075943	8075947	8075950	8075951	8075953	8075955	
				PUR	YK-FS4M12-2AL-WAK3-L/L/S7400	8075992	8075993	8075994	8075998	8076002	8076009	
		公头, M12, 直型 4 针脚, A	母头, M12, 直型 4 针脚, A	PVC	YK-FS4M12-2AL-WAK4-L/L/P00	8076259	8076261	8076262	8076263	8076265	8076266	
				PUR	YK-FS4M12-2AL-WAK4-L/L/S370	8076222	8076224	8076226	8076227	8076228	8076230	
				PUR	YK-FS4M12-2AL-WAK4-L/L/S7400	8076286	8076288	8076289	8076291	8076292	8076294	
		公头, M12, 直型 4 针脚, A	母头, M12, 弯型 3 针脚, A	PVC	YK-FS4M12-2AL-WWAK3-L/L/P00	8076082	8076085	8076089	8076092	8076094	8076096	
				PUR	YK-FS4M12-2AL-WWAK3-L/L/S370	8076038	8076045	8076048	8076052	8076055	8076062	
				PUR	YK-FS4M12-2AL-WWAK3-L/L/S7400	8076108	8076109	8076110	8076111	8076112	8076113	

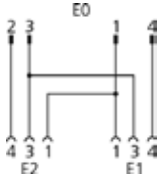
L = 电缆长度

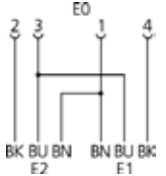
		E0	E1 + E2	电缆	产品描述	0,3m	0,6m	1m	2m	3m	5m	10m
		公头, M12, 直型 4 针脚, A	母头, M12, 弯型 4 针脚, A	PVC	YK-FS4M12-2AL-WWAK4-L/L/P00	8076357	8076358	8076359	8076360	8076361	8076362	
				PUR	YK-FS4M12-2AL-WWAK4-L/L/S370	8076333	8076334	8076336	8076338	8076340	8076343	
				PUR	YK-FS4M12-2AL-WWAK4-L/L/S7400	8076367	8076368	8076369	8076370	8076371	8076372	
		公头, M12, 直型 4 针脚, A	母头, M12, 弯型, 带LED 3 针脚, A	PVC	YK-FS4M12-2AL-WWAK3P2-L/L/P00	8076126	8076127	8076129	8076130	8076132	8076134	
				PUR	YK-FS4M12-2AL-WWAK3P2-L/L/S370	8076117	8076119	8076121	8076123	8076124	8076125	
				PUR	YK-FS4M12-2AL-WWAK3P2-L/L/S7400	8076136	8076138	8076139	8076141	8076142	8076143	
		公头, M12, 直型 4 针脚, A	母头, M12, 弯型, 带LED 4 针脚, A	PVC	YK-FS4M12-2AL-WWAK4P2-L/L/P00	8076386	8076387	8076388	8076389	8076390	8076391	
				PUR	YK-FS4M12-2AL-WWAK4P2-L/L/S370	8076374	8076375	8076376	8076377	8076378	8076379	
				PUR	YK-FS4M12-2AL-WWAK4P2-L/L/S7400	8076395	8076396	8076397	8076398	8076399	8076400	
		公头, M12, 直型 4 针脚, A	母头, M8, 直型 3 针脚, A	PVC	YK-FS4M12-2AL-SKP3-L/L/P00	8076114	8076115	8076116	8076118	8076120	8076122	
				PUR	YK-FS4M12-2AL-SKP3-L/L/S370	8076101	8076103	8076104	8076105	8076106	8076107	
				PUR	YK-FS4M12-2AL-SKP3-L/L/S7400	8076128	8076131	8076133	8076135	8076137	8076140	
		公头, M12, 直型 4 针脚, A	母头, M8, 直型 4 针脚, A	PVC	YK-FS4M12-2AL-SKP4-L/L/P00	8075923	8075924	8075926	8075928	8075932	8075936	
				PUR	YK-FS4M12-2AL-SKP4-L/L/S370	8075914	8075917	8075918	8075919	8075920	8075921	
				PUR	YK-FS4M12-2AL-SKP4-L/L/S7400	8075938	8075939	8075940	8075941	8075945	8075949	
		公头, M12, 直型 4 针脚, A	母头, M8, 弯型 3 针脚, A	PVC	YK-FS4M12-2AL-SWKP3-L/L/P00	8076150	8076151	8076152	8076153	8076154	8076157	
				PUR	YK-FS4M12-2AL-SWKP3-L/L/S370	8076144	8076145	8076146	8076147	8076148	8076149	
				PUR	YK-FS4M12-2AL-SWKP3-L/L/S7400	8076268	8076270	8076272	8076275	8076280	8076284	
		公头, M12, 直型 4 针脚, A	母头, M8, 弯型 4 针脚, A	PVC	YK-FS4M12-2AL-SWKP4-L/L/P00	8076012	8076016	8076019	8076022	8076023	8076024	
				PUR	YK-FS4M12-2AL-SWKP4-L/L/S370	8075952	8075954	8075958	8075997	8076003	8076006	
				PUR	YK-FS4M12-2AL-SWKP4-L/L/S7400	8076025	8076026	8076027	8076029	8076032	8076035	

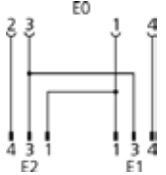
L = 电缆长度

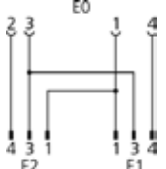





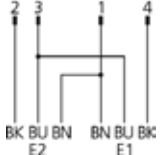



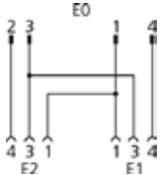

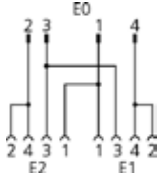
		E0	E1 + E2	电缆	产品描述	0,3m	0,6m	1m	2m	3m	5m	10m	
		公头, M12, 直型 4 针脚, A	母头, M8, 弯型, 带 LED 3 针脚, A	PVC	YK-FS4M12-2AL-SWKP3P2-L/L/P00	8075859	8076363	8076364	8076365	8076366	8076373		
				PUR	YK-FS4M12-2AL-SWKP3P2-L/L/S370	8076320	8076322	8076324	8076327	8076329	8076331		
				PUR	YK-FS4M12-2AL-SWKP3P2-L/L/S7400	8076380	8076381	8076382	8076383	8076384	8076385		
		公头, M12, 直型 4 针脚, A	母头, M8, 弯型, 带 LED 4 针脚, A	PVC	YK-FS4M12-2AL-SWKP4P2-L/L/P00	8076049	8076050	8076057	8076061	8076064	8076067		
				PUR	YK-FS4M12-2AL-SWKP4P2-L/L/S370	8076039	8076042	8076043	8076044	8076046	8076047		
				PUR	YK-FS4M12-2AL-SWKP4P2-L/L/S7400	8076070	8076071	8076072	8076073	8076076	8076079		
		公头, M12, 直型 4 针脚, A	母头, M8, 直型 4 针脚, A	PUR	YK-FS4M12-2AL-SKP4.028-L/L/S370	8086653	8086654	8086655	8086582	8086656	8086583		
		公头, M12, 直型 4 针脚, A	母头, M8, 弯型 4 针脚, A	PUR	YK-FS4M12-2AL-SWKP4.028-L/L/S370	8086657	8086658	8086659	8086585	8086660	8086586		
		母头, M8, 直型 4 针脚, A	开放式线缆端口	PVC	YK-FK4M8-L/L/P00				8074375		8075666	8075667	
				PUR	YK-FK4M8-L/L/S370				8074373		8075664	8075665	
				PUR	YK-FK4M8-L/L/S7400				8074376		8075668	8075669	
		母头, M8, 直型 4 针脚, A	公头, M8, 直型 3 针脚, A	PVC	YK-FK4M8-2AL-SSP3-L/L/P00	8075855	8075929	8075931	8075933	8075934	8075935		
				PUR	YK-FK4M8-2AL-SSP3-L/L/S370	8075846	8075911	8075912	8075913	8075915	8075916		
				PUR	YK-FK4M8-2AL-SSP3-L/L/S7400	8075961	8075963	8075964	8075965	8075966	8075967		
		母头, M8, 直型 4 针脚, A	公头, M12, 直型 3 针脚, A	PVC	YK-FK4M8-2AL-WAS3-L/L/P00	8075995	8075996	8076000	8076001	8076004	8076007		
				PUR	YK-FK4M8-2AL-WAS3-L/L/S370	8075980	8075981	8075982	8075984	8075986	8075989		
				PUR	YK-FK4M8-2AL-WAS3-L/L/S7400	8076059	8076063	8076065	8076066	8076068	8076069		

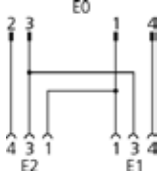

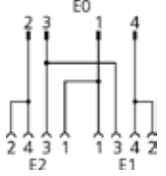
L = 电缆长度

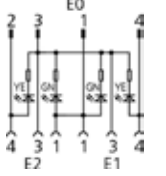
		E0	E1 + E2	电缆	产品描述	0,3m	0,6m	1m	2m	3m	5m	10m	
		公头, M8, 直型 4 针脚, A	母头, M12, 直型 3 针脚, A	PVC	YK-FS4M8-2AL-WAK3-L/L/P00	8076231	8076232	8076233	8076234	8076236	8076239		
				PUR	YK-FS4M8-2AL-WAK3-L/L/S370	8076215	8076219	8076221	8076223	8076225	8076229		
				PUR	YK-FS4M8-2AL-WAK3-L/L/S7400	8076243	8076244	8076245	8076246	8076247	8076248		
		公头, M8, 直型 4 针脚, A	母头, M12, 直型 4 针脚, A	PVC	YK-FS4M8-2AL-WAK4-L/L/P00	8076235	8076237	8076238	8076240	8076241	8076242		
				PUR	YK-FS4M8-2AL-WAK4-L/L/S370	8076213	8076214	8076216	8076217	8076218	8076220		
				PUR	YK-FS4M8-2AL-WAK4-L/L/S7400	8076250	8076251	8076253	8076255	8076256	8076258		
		公头, M8, 直型 4 针脚, A	母头, M12, 弯型 3 针脚, A	PVC	YK-FS4M8-2AL-WWAK3-L/L/P00	8076267	8076269	8076271	8076273	8076276	8076283		
				PUR	YK-FS4M8-2AL-WWAK3-L/L/S370	8076249	8076252	8076254	8076257	8076260	8076264		
				PUR	YK-FS4M8-2AL-WWAK3-L/L/S7400	8076285	8076287	8076290	8076293	8076295	8076296		
		公头, M8, 直型 4 针脚, A	母头, M12, 弯型 4 针脚, A	PVC	YK-FS4M8-2AL-WWAK4-L/L/P00	8076297	8076298	8076300	8076301	8076302	8076303		
				PUR	YK-FS4M8-2AL-WWAK4-L/L/S370	8076274	8076277	8076278	8076279	8076281	8076282		
				PUR	YK-FS4M8-2AL-WWAK4-L/L/S7400	8076309	8076311	8076312	8076315	8076318	8076319		
		公头, M8, 直型 4 针脚, A	母头, M12, 弯型, 带LED 3 针脚, A	PVC	YK-FS4M8-2AL-WWAK3P2-L/L/P00	8076310	8076313	8076314	8076316	8076317	8076321		
				PUR	YK-FS4M8-2AL-WWAK3P2-L/L/S370	8076299	8076304	8076305	8076306	8076307	8076308		
				PUR	YK-FS4M8-2AL-WWAK3P2-L/L/S7400	8076323	8076325	8076326	8076328	8076330	8076332		
		公头, M8, 直型 4 针脚, A	母头, M12, 弯型, 带LED 4 针脚, A	PVC	YK-FS4M8-2AL-WWAK4P2-L/L/P00	8076345	8076346	8076347	8076348	8076349	8076350		
				PUR	YK-FS4M8-2AL-WWAK4P2-L/L/S370	8076335	8076337	8076339	8076341	8076342	8076344		
				PUR	YK-FS4M8-2AL-WWAK4P2-L/L/S7400	8076351	8076352	8076353	8076354	8076355	8076356		
		公头, M8, 直型 4 针脚, A	开放式线缆端口	PVC	YK-FS4M8-L/L/P00				8074377		8075672	8075673	
				PUR	YK-FS4M8-L/L/S370				8074374		8075670	8075671	
				PUR	YK-FS4M8-L/L/S7400				8074378		8075674	8075675	

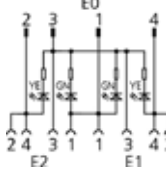
L = 电缆长度

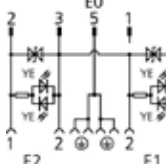
		E0	E1 + E2	电缆	产品描述	0,3m	0,6m	1m	2m	3m	5m	10m
		公头, M8, 直型 4 针脚, A	母头, M8, 直型 3 针脚, A	PVC	YK-FS4M8-2AL-SKP3-L/L/P00	8075972	8075974	8075975	8075976	8075977	8075978	
				PUR	YK-FS4M8-2AL-SKP3-L/L/S370	8075857	8075956	8075957	8075959	8075960	8075962	
				PUR	YK-FS4M8-2AL-SKP3-L/L/S7400	8075983	8075985	8075987	8075988	8075990	8075991	
		公头, M8, 直型 4 针脚, A	母头, M8, 直型 4 针脚, A	PVC	YK-FS4M8-2AL-SKP4-L/L/P00	8076162	8076163	8076164	8076165	8076166	8076167	
				PUR	YK-FS4M8-2AL-SKP4-L/L/S370	8076155	8076156	8076158	8076159	8076160	8076161	
				PUR	YK-FS4M8-2AL-SKP4-L/L/S7400	8076168	8075856	8076169	8076170	8076171	8076172	
		公头, M8, 直型 4 针脚, A	母头, M8, 弯型 3 针脚, A	PVC	YK-FS4M8-2AL-SWKP3-L/L/P00	8075858	8076031	8076033	8076036	8076037	8076040	
				PUR	YK-FS4M8-2AL-SWKP3-L/L/S370	8076008	8076010	8076013	8076015	8076017	8076020	
				PUR	YK-FS4M8-2AL-SWKP3-L/L/S7400	8076051	8076053	8076054	8076056	8076058	8076060	
		公头, M8, 直型 4 针脚, A	母头, M8, 弯型 4 针脚, A	PVC	YK-FS4M8-2AL-SWKP4-L/L/P00	8076392	8076393	8076394	8076401	8076402	8076403	
				PUR	YK-FS4M8-2AL-SWKP4-L/L/S370	8076173	8076174	8076175	8076176	8076177	8076178	
				PUR	YK-FS4M8-2AL-SWKP4-L/L/S7400	8076404	8076405	8076406	8076407	8076408	8076409	
		公头, M8, 直型 4 针脚, A	母头, M8, 弯型, 带 LED 3 针脚, A	PVC	YK-FS4M8-2AL-SWKP3P2-L/L/P00	8076084	8076086	8076088	8076090	8076091	8076093	
				PUR	YK-FS4M8-2AL-SWKP3P2-L/L/S370	8076074	8076075	8076077	8076078	8076080	8076081	
				PUR	YK-FS4M8-2AL-SWKP3P2-L/L/S7400	8076095	8076097	8076098	8076099	8076100	8076102	
		公头, M8, 直型 4 针脚, A	母头, M8, 弯型, 带 LED 4 针脚, A	PVC	YK-FS4M8-2AL-SWKP4P2-L/L/P00	8076419	8076420	8076421	8076422	8076423	8076424	
				PUR	YK-FS4M8-2AL-SWKP4P2-L/L/S370	8076413	8076414	8076415	8076416	8076417	8076418	
				PUR	YK-FS4M8-2AL-SWKP4P2-L/L/S7400	8076425	8076426	8076427	8076428	8076429	8076430	
		公头, M12, 直型 5 针脚, A	母头, A 阀, 弯型 2+PE, PE 桥接 针脚	PVC	YK-FS5M12-2VA22-24.3-L/L/P00	8077612	8077671	8077614	8077615	8077616	8077617	
				PUR	YK-FS5M12-2VA22-24.3-L/L/S370	8077604	8077606	8077608	8077609	8077610	8077611	

L = 电缆长度

		E0	E1 + E2	电缆	产品描述	0,3m	0,6m	1m	2m	3m	5m	10m
		公头, M12, 直型 5 针脚, A	母头, B 阀, 直型 2+PE 针脚	PVC	YK-FS5M12-2VB21-24.3-L/L/P00	8077627	8077673	8077631	8077633	8077635	8077637	
		PUR	YK-FS5M12-2VB21-24.3-L/L/S370	8077618	8077672	8077620	8077621	8077623	8077625			
		公头, M12, 直型 5 针脚, A	母头, B 阀, 弯型 2+PE 针脚	PVC	YK-FS5M12-2VBI21-24.3-L/L/P00	8077603	8077605	8077607	8077622	8077624	8077626	
		PUR	YK-FS5M12-2VBI21-24.3-L/L/S370	8077639	8077674	8077644	8077646	8077648	8077651			
		公头, M12, 直型 5 针脚, A	母头, C 阀, 弯型 2+PE, PE 桥接 针脚	PVC	YK-FS5M12-2VC22-24.4-L/L/P00	8077640	8077641	8077643	8077645	8077647	8077649	
		PUR	YK-FS5M12-2VC22-24.4-L/L/S370	8077628	8077630	8077632	8077634	8077636	8077638			
		公头, M12, 直型 5 针脚, A	母头, C 阀, 弯型 2+PE, PE 桥接 针脚	PVC	YK-FS5M12-2VCI22-24.4-L/L/P00	8077658	8077659	8077660	8077661	8077663	8077664	
		PUR	YK-FS5M12-2VCI22-24.4-L/L/S370	8077650	8077652	8077654	8077655	8077656	8077657			

命名

8	I/O	M8-	3	P2	T	L /	S370
							电缆材质
							电缆长度 [m] C型 带连接电缆
							连接: T: 顶端   F: 前端   C: 电缆
							PNP   LED + 电路
							触点分布编码
							输入/输出端口: M8,   Ø8mm 快接 (S8)   M12
							输入/输出分线盒
							输入/输出端口数量

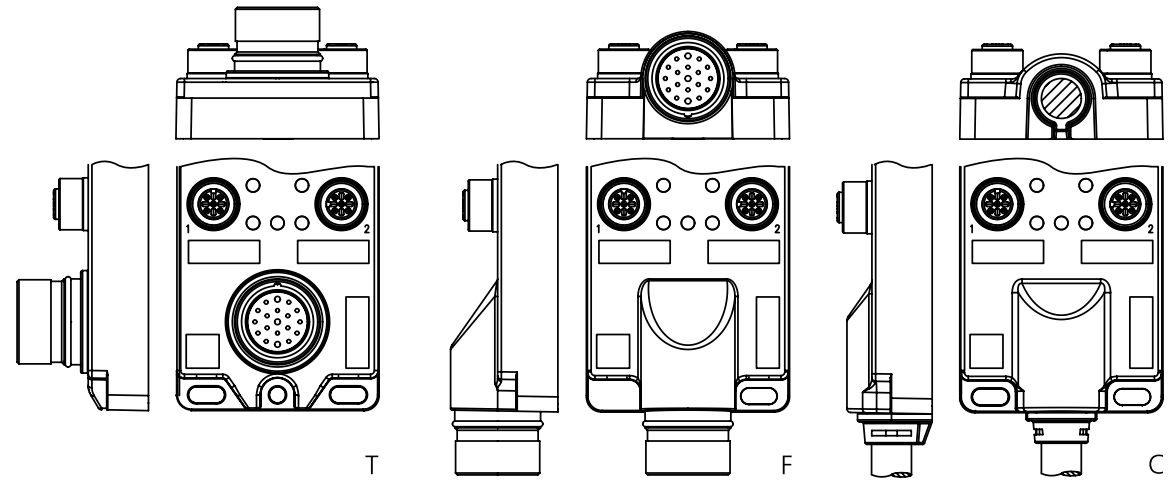

电缆	材料	UL	颜色	特性	可适应拖链	抗扭	抗焊接火花
P01	PVC/PVC	✓	GY				
S370	PUR/PP	✓	BK		✓	✓	✓

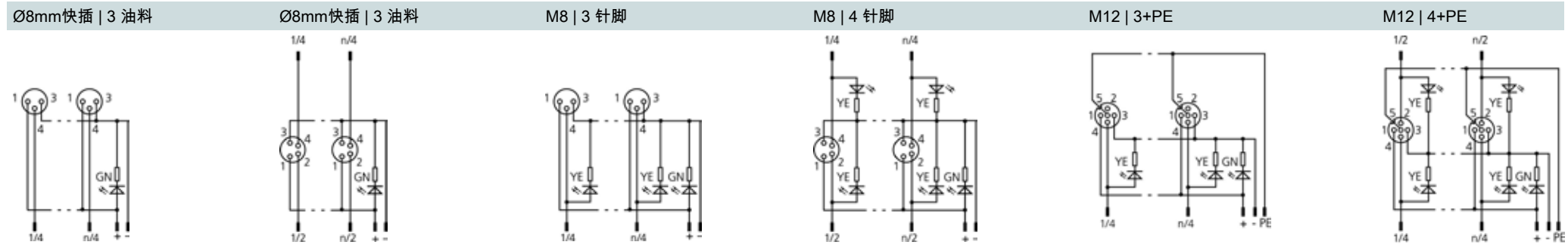











## I/O-分线盒 | 被动

技术参数	M12	M8	Ø8mm snap
绝缘电阻	≥10 <sup>8</sup> Ω	≥10 <sup>8</sup> Ω	≥10 <sup>8</sup> Ω
电阻	≤ 5mΩ	≤ 5mΩ	≤ 5mΩ
产品环境温度	-30°C...+90°C	-30°C...+90°C	-30°C...+90°C
触点材料	合金, 铜锌, 镀金	合金, 铜锌, 镀金	合金, 铜锌, 镀金
触头载体材料	塑料, PA, 黑色	塑料, PA, 黑色	塑料, PA, 黑色
密封(母头)材料	FPM/FKM	FPM/FKM	FPM/FKM
标准	IEC 61076-2-101	IEC 61076-2-104	IEC 61076-2-104
防护等级 (安装好)	IP65,IP67	IP65,IP67	IP65,IP67
机械寿命周期	>100 插拔次数	>100 插拔次数	>100 插拔次数
污染等级	3	3	3

来自ESCHA M8和M12无源分配器紧凑的整体风格和灵活的安装能力尤其突出。凭借充分有效地灌胶和内嵌的金属螺纹来满足IP65和IP67防护等级需求，他们尤其适合于苛刻的工业应用。由于产品提供不同的出线类型（固定电缆连接、顶端或者前端连接），您总能找到所需产品。

				L = 电缆长度							
		I/O口数量	输入输出针脚	端口	ΣI[max]	产品描述	公头	2m	5m	10m	15m
	I/O-分线盒 被动, M12, 顶端	4	3+PE	M23 , 12针脚	12A	4I/OM12-5.4P2T	8048790				
			4+PE	M23 , 19针脚	12A	4I/OM12-5P3T	8045895				
	I/O-分线盒 被动, M12, 侧端	4	3+PE	M23 , 12针脚	12A	4I/OM12-5.4P2F	8048791				
			4+PE	M23 , 19针脚	12A	4I/OM12-5P3F	8045891				
	I/O-分线盒 被动, M12, 固定电缆连接	4	3+PE		12A	4I/OM12-5.4P2C-L/S370		8048792			
			4+PE		12A	4I/OM12-5P3C-L/S370		8045894			
	I/O-分线盒 被动, M12, 顶端	6	3+PE	M23 , 12针脚	12A	6I/OM12-5.4P2T	8048787				
			4+PE	M23 , 19针脚	12A	6I/OM12-5P3T	8045896				
	I/O-分线盒 被动, M12, 侧端	6	3+PE	M23 , 12针脚	12A	6I/OM12-5.4P2F	8048788				
			4+PE	M23 , 19针脚	12A	6I/OM12-5P3F	8045892				
	I/O-分线盒 被动, M12, 固定电缆连接	6	3+PE		12A	6I/OM12-5.4P2C-L/S370		8048789			
			4+PE		12A	6I/OM12-5P3C-L/S370		8045893			
	I/O-分线盒 被动, M12, 顶端	8	3+PE	M23 , 12针脚	12A	8I/OM12-5.4P2T	8048784				
			4+PE	M23 , 19针脚	12A	8I/OM12-5P3T	8045647				
	I/O-分线盒 被动, M12, 侧端	8	3+PE	M23 , 12针脚	12A	8I/OM12-5.4P2F	8048785				
			4+PE	M23 , 19针脚	12A	8I/OM12-5P3F	8045649				
	I/O-分线盒 被动, M12, 固定电缆连接	8	3+PE		12A	8I/OM12-5.4P2C-L/S370		8048786			
			4+PE		12A	8I/OM12-5P3C-L/S370		8045648			
	I/O-分线盒 被动, M8, 顶端	4	3	M12 , 8针脚	2A	4I/OM8-3P2T	8061747				

I/O 分线盒 | 被动

				L = 电缆长度							
		I/O口数量	输入输出针脚	端口	ΣI[max]	产品描述	公头	2m	5m	10m	15m
	I/O-分线盒 被动, M8, 固定电缆连接	4	3		6A	4I/OM8-3P2C-L/S370		8061768	8061776	8061777	8061778
			4		6A	4I/OM8-4P3C-L/S370		8061783	8061784	8061785	8061786
	I/O-分线盒 被动, M8, 顶端	8	3	M12, 12针脚	1.5A	8I/OM8-3P2T	8061744				
	I/O-分线盒 被动, M8, 固定电缆连接	8	3		6A	8I/OM8-3P2C-L/S370		8061794	8061796	8061797	8061798
			4		6A	8I/OM8-4P3C-L/S370		8061803	8061804	8061805	8061806
	I/O-分线盒 被动, M8, 顶端	10	3	M12, 12针脚	1.5A	10I/OM8-3P2T	8061633				
	I/O-分线盒 被动, M8, 固定电缆连接	10	3		6A	10I/OM8-3P2C-L/S370		8061811	8061812	8061813	8061814
	I/O-分线盒 被动, Ø8mm 快插, 固定电缆连接	4	3		6A	4I/OS8-3P1C-L/P01		8062806	8062807	8062808	8062809
			3		6A	4I/OS8-3P1C-L/S370		8062789	8062790	8062791	8062792
			4		6A	4I/OS8-4P1C-L/P01		8062817	8062818	8062819	8062820
			4		6A	4I/OS8-4P1C-L/S370		8062813	8062814	8062815	8062816
	I/O-分线盒 被动, Ø8mm 快插, 顶端	4	3	M12, 8针脚	4A	4I/OS8-3P1T	8062601				
			4	M12, 12针脚	1.5A	4I/OS8-4P1T	8062599				
	I/O-分线盒 被动, Ø8mm 快插, 固定电缆连接	10	3		6A	10I/OS8-3P1C-L/P01		8062838	8062839	8062840	8062841
			3		6A	10I/OS8-3P1C-L/S370		8062825	8062826	8062827	8062828
	I/O-分线盒 被动, Ø8mm 快插, 顶端	10	3	M12, 12针脚	1.5A	10I/OS8-3P1T	8062604				

命名

8	I/O	M8-	3	P3	T	8xAND/OR
						逻辑
						连接: T: 顶端, M12x1 12针脚
						PNP   LED + 电路
						触点分布编码
						输入/输出端口: M8x1
						输入/输出分线盒
						输入/输出端口数量

I/O  
分线盒 | 活跃





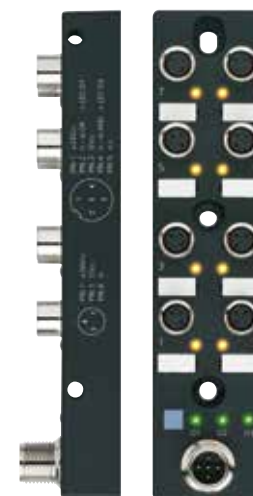
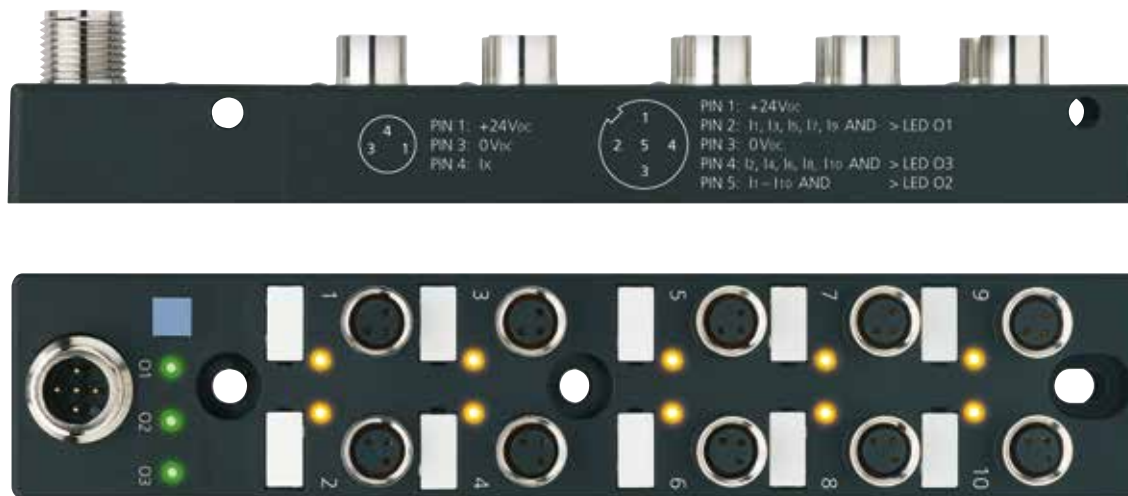































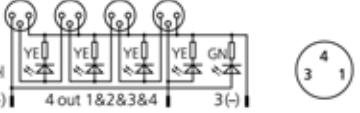

## I/O-分线盒 | 活跃

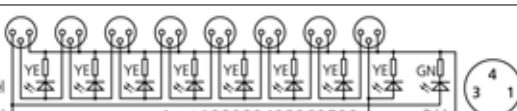
技术参数	M8
绝缘电阻	≥10 <sup>8</sup> Ω
电阻	≤ 5mΩ
产品环境温度	-30°C...+90°C
触点材料	合金, 铜锌, 镀金
触头载体材料	塑料, PA, 黑色
密封(母头)材料	FPM/FKM
标准	IEC 61076-2-104
防护等级 ( 安装好 )	IP65,IP67
机械寿命周期	>100 插拔次数
污染等级	3

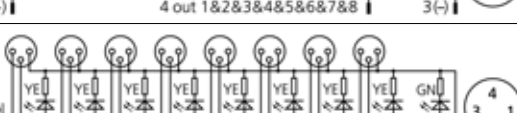
此类相当紧凑并带逻辑运算功能的M8 I/O分线盒能够智能通过传感器向中央控制单元传输预处理信号。相比于传统的分布式的I/O分线盒或者现场总线分线盒，优势在于默认使用四芯或五芯的非屏蔽传感器线缆。正因如此，线缆的成本和接线时间都能减少同时能够避免接线的错误。此类分线盒不需要用户来编程，由于逻辑功能的预定义因而可以立即使用。适用于各种机械手，机器人或者紧凑的处理单元。

		I/O口数量			$\Sigma I[\text{max}]$	产品描述	物料编号
	I/O-分线盒 活跃, M8, 顶端 4x 主动 AND/OR 逻辑电路	4			1A	4I/OM8-3P3T 4x AND/OR	8081123
	I/O-分线盒 活跃, M8, 顶端 2x2 主动 AND 逻辑电路	4			1A	4I/OM8-3P4T 2x2 AND	8081125
	I/O-分线盒 活跃, M8, 顶端 2x2 主动 OR 逻辑电路	4			1A	4I/OM8-3P4T 2x2 OR	8081127
	I/O-分线盒 活跃, M8, 顶端 8x 主动 AND/OR 逻辑电路	8			1A	8I/OM8-3P3T 8x AND/OR	8081129
	I/O-分线盒 活跃, M8, 顶端 2x4 主动 AND 逻辑电路	8			1A	8I/OM8-3P4T 2x4 AND	8081131
	I/O-分线盒 活跃, M8, 顶端 2x4 主动 OR 逻辑电路	8			1A	8I/OM8-3P4T 2x4 OR	8081133
	I/O-分线盒 活跃, M8, 顶端 10x 主动 AND/OR 逻辑电路	10			1A	10I/OM8-3P3T 10x AND/OR	8081135
	I/O-分线盒 活跃, M8, 顶端 2x5 主动 AND 逻辑电路	10			1A	10I/OM8-3P4T 2x5 AND	8081137
	I/O-分线盒 活跃, M8, 顶端 4x 主动 AND 逻辑电路	4			4A	4I/OM8-3P2T 4x passiv AND	8062606
	I/O-分线盒 活跃, M8, 顶端 8x 主动 AND 逻辑电路	8			4A	8I/OM8-3P2T 8x passiv AND	8062608
	I/O-分线盒 活跃, M8, 顶端 2x4 主动 AND 逻辑电路	8			4A	8I/OM8-3P2T 2x4 passiv AND	8062610
	模拟插头 公头, M8x1, 直型	3			4A	AL-SSP3-AS/S2065	8063927



命名

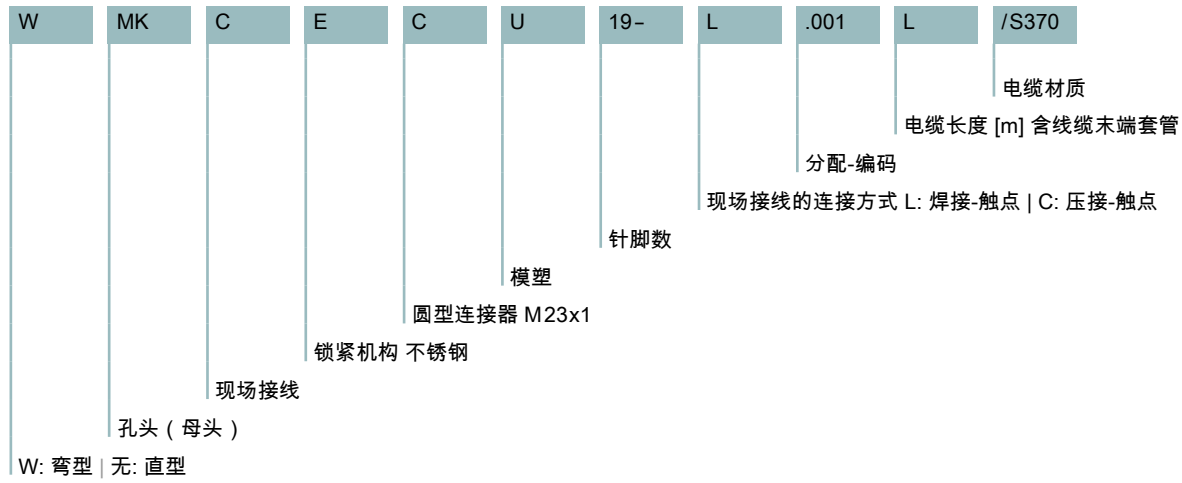





电缆	材料	UL	颜色	特性	可适应拖链	抗扭	抗焊接火花
S370	PUR/PP	✓	BK		✓	✓	✓



## M23

技术参数	M23x1	现场接线连接器
绝缘电阻	≥10 <sup>8</sup> Ω	≥10 <sup>8</sup> Ω
产品环境温度	-30°C...+90°C	-40°C...+85°C
触点材料	合金，镀金	合金，铜锌，镀金
触头载体材料	塑料，PBT	塑料，PBT，灰色
夹紧基体材料	塑料，TPU	合金，铜锌，镀镍，镀银
连接螺母材料	合金，镀镍	合金，铜锌，镀镍
密封(母头)材料	塑料，NBR	塑料，NBR
防护等级（安装好）	IP65,IP67	
机械寿命周期	>100 插拔次数	>100 插拔次数
污染等级	3	3
电缆出口		12 针脚: 8...12mm, 19 针脚: 10...14mm
连接横截面积		12 针脚: 连接触点 10,11,12 0.75...1.0mm <sup>2</sup>   其他全部连接触点 0.5...0.75mm <sup>2</sup> 19 针脚: 连接触点 6,12,19 0.75...1.0mm <sup>2</sup>   其他全部连接触点 0.5...0.75mm <sup>2</sup>
连接类型		焊接连接

预注式和现场接线式M23连接器可以很好的适用于M12的分线盒上。你能选择具有不同配置的12芯和19芯版本产品。另外，ESCHA具有‘S370’高品质电缆，M23连接器可以使用在不同应用场合。

		顶端			电缆			产品描述	L = 电缆长度*		
		针脚	最大电压	最大电流	材料	颜色	UL		2m / 1m	5m / 2m	10m / 5m
 延长电缆 母头, 直型, M23	12	125V	4A   8A(接触点10,11,12)	PUR	BK		MKCU12.001-L/S370	8027363	8026032	8026033	
	12	125V	4A   8A(接触点10,11,12)	PUR	BK		MKCU12.003-L/S370	8026243	8026039	8026041	
	19	125V	4A   10A(接触点9,12,19)	PUR	BK		MKCU19.001-L/S370	8027364	8026036	8026037	
	19	125V	4A   10A(接触点9,12,19)	PUR	BK		MKCU19.003-L/S370	8027365	8017221	8017222	
 延长电缆 母头, 弯型, M23	12	125V	4A   8A(接触点10,11,12)	PUR	BK		WMKCU12.001-L/S370	8027366	8026043	8026044	
	12	125V	4A   8A(接触点10,11,12)	PUR	BK		WMKCU12.003-L/S370	8026244	8026049	8026050	
	19	125V	4A   10A(接触点9,12,19)	PUR	BK		WMKCU19.001-L/S370	8027368	8026046	8026047	
	19	125V	4A   10A(接触点9,12,19)	PUR	BK		WMKCU19.003-L/S370	8027370	8017111	8017112	
 现场接线连接器 母头, 直型, M23 焊接连接	12	150V	4A   8A(接触点10,11,12)				MKCC12L	8013694			
	19	125V	4A   10A(接触点9,12,19)				MKCC19L	8013696			
 现场接线连接器 母头, 弯型, M23 焊接连接	12	150V	4A   8A(接触点10,11,12)				WMKCC12L	8017153			
	19	125V	4A   10A(接触点9,12,19)				WMKCC19L	8017151			



类型	触点	U <sub>[max]</sub>	接线	电缆长度	B侧
VA A	21 2+PE	24 24VDC   24VAC/DC	0 直通	L 延长电缆 连接电缆	电缆开放侧
VAA A 直型	22 2+PE跳线	60 60VAC/DC	1 LED	L1/L2 双阀连接器	DA22-24.3 双阀连接器
VAAG A 直型 螺纹压头	31 3+PE	230 230VAC/DC	2 LED, 压力开关		WAS5.002 M12x1转接头, 阀
VB B (10mm 触点间隙)	41 3+PE+电缆-连接		3 LED + 抑制二极管		
VBI BI (11mm 触点间隙)			4 LED + 齐纳二极管		
VC C (8mm 触点间隙)			5 LED + 压敏电阻		
VCI CI (9.4mm 触点间隙)					

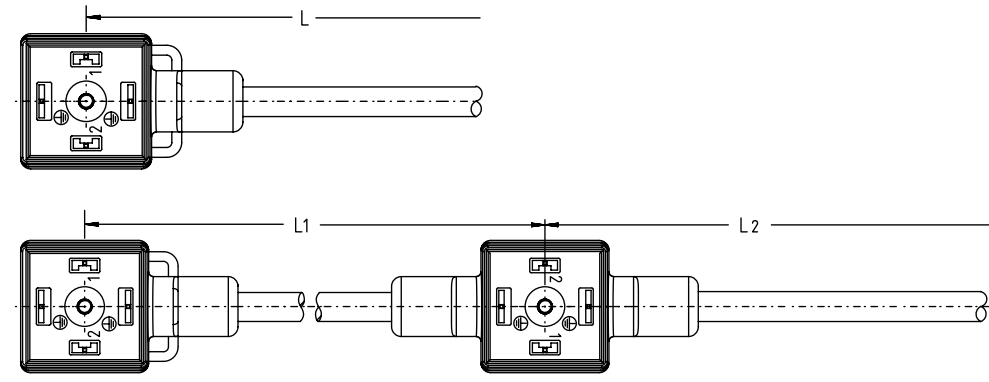
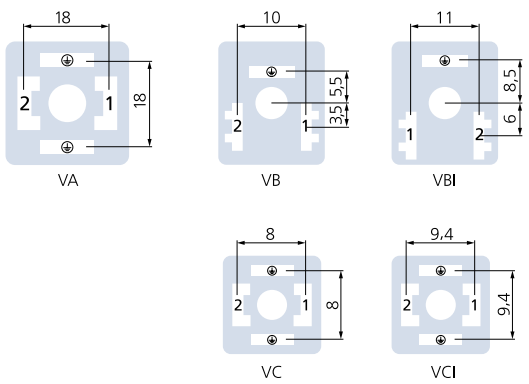

电缆	材料	UL	颜色	特性	可适应拖链	抗扭	抗焊接火花
P00	PVC/PVC		GY				
P01	PVC/PVC	✓	GY				
S370	PUR/PP	✓	BK		✓	✓	✓

阀连接器

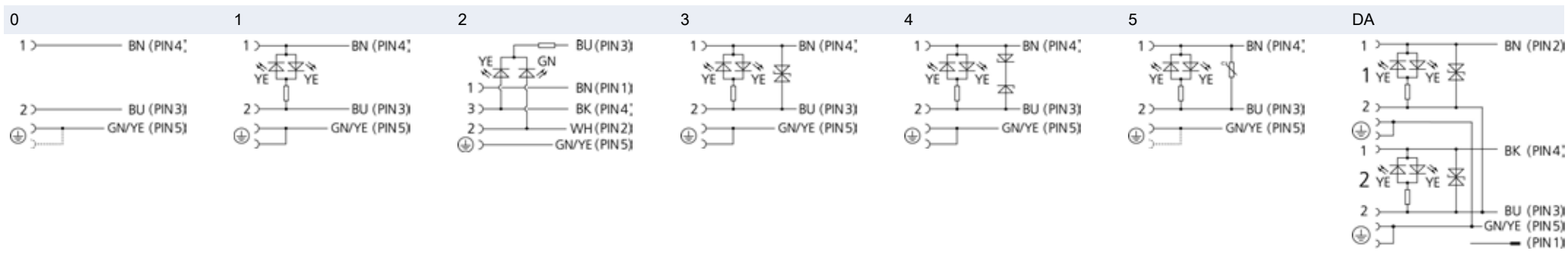









## 阀连接器

技术参数	阀连接器	M12
绝缘电阻	≥10 <sup>9</sup> Ω	≥10 <sup>9</sup> Ω
产品环境温度	-30°C...+90°C	-30°C...+90°C
触点材料	合金，镀银	合金，镀金
触头载体材料	塑料，PA	塑料，TPU
夹紧基体材料	塑料，TPU	塑料，TPU
密封(母头)材料	塑料，TPU	
标准	DIN EN 175301-803	IEC 61076-2-101
防护等级（安装好）	IP65, IP67, IP68	IP65, IP67, IP68
机械寿命周期	>100 插拔次数	>100 插拔次数
污染等级	3	3





ESCHA的阀连接器代表着最小安装空间，同时所有安装位置出色的LED能见度。可提供标准的插座型号和保护电路。带有延长电缆和接线电缆，以及转接头和双头阀连接器的广泛的产品项目能为任何应用提供解决方案。

	顶端			电缆			产品描述	L /L2 = 电缆 长度		
	针脚	最大电压	电路	材料	颜色	L1[m]		2m / 1m	5m / 2m	10m / 5m
 延长电缆 母头, 弯型, A 阀	2+PE	230V <sub>AC/DC</sub>	不带抑制电路	PUR	BK		VA21-230.0-L/S370	8050753	8047806	8050754
		230V <sub>AC/DC</sub>	不带抑制电路	PVC	GY		VA21-230.0-L/P00	8048838	8048841	8050824
		230V <sub>AC/DC</sub>	不带抑制电路	PVC	GY		VA21-230.0-L/P01	8050873	8047823	8050874
	2+PE, PE 桥接	230V <sub>AC/DC</sub>	不带抑制电路	PUR	BK		VA22-230.0-L/S370	8052299	8052300	8052301
		230V <sub>AC/DC</sub>	不带抑制电路	PVC	GY		VA22-230.0-L/P00	8052302	8052303	8052304
		230V <sub>AC/DC</sub>	不带抑制电路	PVC	GY		VA22-230.0-L/P01	8052305	8052306	8052307
		230V <sub>AC/DC</sub>	压敏电阻	PUR	BK		VA22-230.5-L/S370	8050755	8046704	8050756
		230V <sub>AC/DC</sub>	压敏电阻	PVC	GY		VA22-230.5-L/P00	8050827	8048819	8050828
		230V <sub>AC/DC</sub>	压敏电阻	PVC	GY		VA22-230.5-L/P01	8050875	8047824	8050876
		30V <sub>AC/DC</sub>	不带抑制电路	PUR	BK		VA22-24.1-L/S370	8050501	8047803	8048240
		30V <sub>AC/DC</sub>	不带抑制电路	PVC	GY		VA22-24.1-L/P00	8050819	8048818	8050820
		30V <sub>AC/DC</sub>	不带抑制电路	PVC	GY		VA22-24.1-L/P01	8050861	8046613	8050862
	3+PE	230V <sub>AC/DC</sub>	不带抑制电路	PUR	BK		VA31-230.0-L/S370	8058325	8059241	8059242
		230V <sub>AC/DC</sub>	不带抑制电路	PVC	GY		VA31-230.0-L/P00	8061939	8066062	8062016
		230V <sub>AC/DC</sub>	不带抑制电路	PVC	GY		VA31-230.0-L/P01	8081356	8081355	8061577
3+PE	30V <sub>AC/DC</sub>	抑制二极管	PUR	BK		VA31-24.3-L/S370	8067058	8065473	8078853	
	30V <sub>AC/DC</sub>	抑制二极管	PVC	GY		VA31-24.3-L/P00	8081328	8081329	8081330	
	30V <sub>AC/DC</sub>	抑制二极管	PVC	GY		VA31-24.3-L/P01	8081331	8081332	8081333	
3+PE	30V <sub>DC</sub>	不带抑制电路	PUR	BK		VA41-24.2-L/S370	8050500	8047805	8049933	
	30V <sub>DC</sub>	不带抑制电路	PVC	GY		VA41-24.2-L/P00	8050822	8049310	8050540	
	30V <sub>DC</sub>	不带抑制电路	PVC	GY		VA41-24.2-L/P01	8050865	8047822	8050866	
 延长电缆 母头, 直型, AA 阀	2+PE	230V <sub>AC/DC</sub>	不带抑制电路	PUR	BK		VAA21-230.0-L/S370	8055720	8055721	8055722
		230V <sub>AC/DC</sub>	不带抑制电路	PVC	GY		VAA21-230.0-L/P00	8055726	8055727	8055728
		230V <sub>AC/DC</sub>	不带抑制电路	PVC	GY		VAA21-230.0-L/P01	8055732	8055733	8055734

标准连接器的长度:2米,5米,或10 米。中继电缆长度:1米,2米或5米。法兰面板安装的电线长度:0.5米(0.2米)。其他电缆,电线长度可按照客户要求定制。

	针脚	顶端		电缆			产品描述	L / L2 = 电缆 长度		
		最大电压	电路	材料	颜色	L1[m]		2m / 1m	5m / 2m	10m / 5m
 延长电缆 母头, 直型, AA 阀	2+PE, PE 桥接	230V <sub>AC/DC</sub>	压敏电阻	PUR	BK		VAA22-230.5-L/S370	8055666	8055671	8055667
		230V <sub>AC/DC</sub>	压敏电阻	PVC	GY		VAA22-230.5-L/P00	8055690	8055691	8055692
		230V <sub>AC/DC</sub>	压敏电阻	PVC	GY		VAA22-230.5-L/P01	8055712	8055713	8055714
		30V <sub>AC/DC</sub>	不带抑制电路	PUR	BK		VAA22-24.1-L/S370	8055648	8055649	8055650
		30V <sub>AC/DC</sub>	不带抑制电路	PVC	GY		VAA22-24.1-L/P00	8055672	8055673	8055674
		30V <sub>AC/DC</sub>	不带抑制电路	PVC	GY		VAA22-24.1-L/P01	8055696	8055697	8055698
		30V <sub>AC/DC</sub>	抑制二极管	PUR	BK		VAA22-24.3-L/S370	8055654	8055655	8055656
		30V <sub>AC/DC</sub>	抑制二极管	PVC	GY		VAA22-24.3-L/P00	8055679	8055680	8055678
		30V <sub>AC/DC</sub>	抑制二极管	PVC	GY		VAA22-24.3-L/P01	8055701	8055702	8055703
3+PE	30V <sub>DC</sub>	不带抑制电路	PUR	BK		VAA41-24.2-L/S370	8055660	8055661	8055662	
	30V <sub>DC</sub>	不带抑制电路	PVC	GY		VAA41-24.2-L/P00	8055685	8055686	8055684	
	30V <sub>DC</sub>	不带抑制电路	PVC	GY		VAA41-24.2-L/P01	8055707	8055708	8055709	
 延长电缆 母头, 直型, AAG 阀	2+PE	230V <sub>AC/DC</sub>	不带抑制电路	PUR	BK		VAAG21-230.0-L/S370	8055723	8055724	8055725
		230V <sub>AC/DC</sub>	不带抑制电路	PVC	GY		VAAG21-230.0-L/P00	8055729	8055730	8055731
		230V <sub>AC/DC</sub>	不带抑制电路	PVC	GY		VAAG21-230.0-L/P01	8055735	8055736	8055737
	2+PE, PE 桥接	230V <sub>AC/DC</sub>	压敏电阻	PUR	BK		VAAG22-230.5-L/S370	8055668	8055669	8055670
		230V <sub>AC/DC</sub>	压敏电阻	PVC	GY		VAAG22-230.5-L/P00	8055693	8055694	8055695
		230V <sub>AC/DC</sub>	压敏电阻	PVC	GY		VAAG22-230.5-L/P01	8055715	8055716	8055717
		30V <sub>AC/DC</sub>	不带抑制电路	PUR	BK		VAAG22-24.1-L/S370	8055651	8055652	8055653
		30V <sub>AC/DC</sub>	不带抑制电路	PVC	GY		VAAG22-24.1-L/P00	8055677	8055675	8055676
		30V <sub>AC/DC</sub>	不带抑制电路	PVC	GY		VAAG22-24.1-L/P01	8055699	8055700	8055718
3+PE	30V <sub>AC/DC</sub>	抑制二极管	PUR	BK		VAAG22-24.3-L/S370	8055657	8055658	8055659	
	30V <sub>AC/DC</sub>	抑制二极管	PVC	GY		VAAG22-24.3-L/P00	8055682	8055683	8055681	
	30V <sub>AC/DC</sub>	抑制二极管	PVC	GY		VAAG22-24.3-L/P01	8055704	8055705	8055706	
	30V <sub>DC</sub>	不带抑制电路	PUR	BK		VAAG41-24.2-L/S370	8055663	8055664	8055665	
	30V <sub>DC</sub>	不带抑制电路	PVC	GY		VAAG41-24.2-L/P00	8055688	8055689	8055687	
	30V <sub>DC</sub>	不带抑制电路	PVC	GY		VAAG41-24.2-L/P01	8055719	8055710	8055711	
 延长电缆 母头, 弯型, A 阀 母头, 弯型, D 阀	2+PE, PE 桥接	24V <sub>AC/DC</sub>	抑制二极管	PUR	BK	0.15	VA22-24.3-0,15-DA22-24.3-L/S370	8055743	8055744	8055745
		24V <sub>AC/DC</sub>	抑制二极管	PUR	BK	0.40	VA22-24.3-0,4-DA22-24.3-L/S370	8055746	8055747	8055748
		24V <sub>AC/DC</sub>	抑制二极管	PVC	GY	0.15	VA22-24.3-0,15-DA22-24.3-L/P00	8055749	8055750	8055751
		24V <sub>AC/DC</sub>	抑制二极管	PVC	GY	0.15	VA22-24.3-0,15-DA22-24.3-L/P01	8055755	8055756	8055757
		24V <sub>AC/DC</sub>	抑制二极管	PVC	GY	0.40	VA22-24.3-0,4-DA22-24.3-L/P00	8055752	8055753	8055754
		24V <sub>AC/DC</sub>	抑制二极管	PVC	GY	0.40	VA22-24.3-0,4-DA22-24.3-L/P01	8055758	8055759	8055760

标准连接器的长度:2米,5米,或10 米。中继电缆长度:1米,2米或5米。法兰面板安装的电线长度:0.5米(0.2米)。其他电缆,电线长度可按照客户要求定制。

	针脚	顶端		电缆			产品描述	L / L2 = 电缆 长度		
		最大电压	电路	材料	颜色	L1[m]		2m / 1m	5m / 2m	10m / 5m
 延长电缆 母头, 弯型, A阀 母头, 弯型, D阀 M12, 5针脚	2+PE, PE桥接	24V <sub>AC/DC</sub>	抑制二极管	PUR	BK	0.15	VA22-24.3-0,15-DA22-24.3-WAS5.132/S370	8055761		
		24V <sub>AC/DC</sub>	抑制二极管	PUR	BK	0.40	VA22-24.3-0,4-DA22-24.3-WAS5.132/S370	8055762		
		24V <sub>AC/DC</sub>	抑制二极管	PVC	GY	0.15	VA22-24.3-0,15-DA22-24.3-WAS5.132/P00	8055763		
		24V <sub>AC/DC</sub>	抑制二极管	PVC	GY	0.15	VA22-24.3-0,15-DA22-24.3-WAS5.132/P01	8055765		
		24V <sub>AC/DC</sub>	抑制二极管	PVC	GY	0.40	VA22-24.3-0,4-DA22-24.3-WAS5.132/P00	8055764		
		24V <sub>AC/DC</sub>	抑制二极管	PVC	GY	0.40	VA22-24.3-0,4-DA22-24.3-WAS5.132/P01	8055766		
 延长电缆 母头, 弯型, B阀	2+PE	230V <sub>AC/DC</sub>	不带抑制电路	PUR	BK		VB21-230.0-L/S370	8050760	8047809	8050761
		230V <sub>AC/DC</sub>	不带抑制电路	PVC	GY		VB21-230.0-L/P00	8048842	8048843	8050834
		230V <sub>AC/DC</sub>	不带抑制电路	PVC	GY		VB21-230.0-L/P01	8050881	8047827	8050882
		230V <sub>AC/DC</sub>	压敏电阻	PUR	BK		VB21-230.5-L/S370	8050762	8047810	8050763
		230V <sub>AC/DC</sub>	压敏电阻	PVC	GY		VB21-230.5-L/P00	8050835	8049312	8050836
		230V <sub>AC/DC</sub>	压敏电阻	PVC	GY		VB21-230.5-L/P01	8050883	8047828	8050884
		30V <sub>AC/DC</sub>	不带抑制电路	PUR	BK		VB21-24.1-L/S370	8049246	8047807	8050757
		30V <sub>AC/DC</sub>	不带抑制电路	PVC	GY		VB21-24.1-L/P00	8050829	8049311	8050830
		30V <sub>AC/DC</sub>	不带抑制电路	PVC	GY		VB21-24.1-L/P01	8050877	8047825	8050878
		30V <sub>AC/DC</sub>	抑制二极管	PUR	BK		VB21-24.3-L/S370	8050758	8047808	8050759
		30V <sub>AC/DC</sub>	抑制二极管	PVC	GY		VB21-24.3-L/P00	8048844	8048845	8050832
		30V <sub>AC/DC</sub>	抑制二极管	PVC	GY		VB21-24.3-L/P01	8050879	8047826	8050880
 延长电缆 母头, 弯型, BI阀	2+PE	230V <sub>AC/DC</sub>	不带抑制电路	PUR	BK		VBI21-230.0-L/S370	8050766	8047813	8049931
		230V <sub>AC/DC</sub>	不带抑制电路	PVC	GY		VBI21-230.0-L/P00	8050857	8049314	8050858
		230V <sub>AC/DC</sub>	不带抑制电路	PVC	GY		VBI21-230.0-L/P01	8050904	8047831	8050905
		230V <sub>AC/DC</sub>	压敏电阻	PUR	BK		VBI21-230.5-L/S370	8050767	8047814	8050768
		230V <sub>AC/DC</sub>	压敏电阻	PVC	GY		VBI21-230.5-L/P00	8050859	8048821	8050860
		230V <sub>AC/DC</sub>	压敏电阻	PVC	GY		VBI21-230.5-L/P01	8050906	8047832	8050907
		30V <sub>AC/DC</sub>	不带抑制电路	PUR	BK		VBI21-24.1-L/S370	8050764	8047811	8050539
		30V <sub>AC/DC</sub>	不带抑制电路	PVC	GY		VBI21-24.1-L/P00	8050838	8049313	8050538
		30V <sub>AC/DC</sub>	不带抑制电路	PVC	GY		VBI21-24.1-L/P01	8050899	8047829	8050900
		30V <sub>AC/DC</sub>	抑制二极管	PUR	BK		VBI21-24.3-L/S370	8049884	8047812	8050765
		30V <sub>AC/DC</sub>	抑制二极管	PVC	GY		VBI21-24.3-L/P00	8050855	8048820	8050856
		30V <sub>AC/DC</sub>	抑制二极管	PVC	GY		VBI21-24.3-L/P01	8050901	8047830	8050902
 延长电缆 母头, 弯型, C阀	2+PE	230V <sub>AC/DC</sub>	不带抑制电路	PUR	BK		VC21-230.0-L/S370	8050772	8047817	8050773
		230V <sub>AC/DC</sub>	不带抑制电路	PVC	GY		VC21-230.0-L/P00	8050846	8049317	8050848
		230V <sub>AC/DC</sub>	不带抑制电路	PVC	GY		VC21-230.0-L/P01	8050914	8047835	8050916







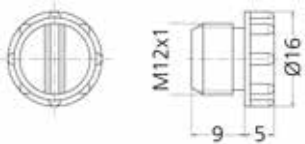

标准连接器的长度:2米,5米,或10米。中继电缆长度:1米,2米或5米。法兰面板安装的电线长度:0.5米(0.2米)。其他电缆,电线长度可按照客户要求定制。

	针脚	顶端		电缆			产品描述	L /L2 = 电缆 长度			
		最大电压	电路	材料	颜色	L1[m]		2m / 1m	5m / 2m	10m / 5m	
	2+PE, PE桥接	30V <sub>AC/DC</sub>	不带抑制电路	PUR	BK		VC22-24.1-L/S370	8050769	8047815	8050770	
		30V <sub>AC/DC</sub>	不带抑制电路	PVC	GY		VC22-24.1-L/P00	8050842	8049315	8050843	
		30V <sub>AC/DC</sub>	不带抑制电路	PVC	GY		VC22-24.1-L/P01	8050909	8047833	8050910	
		30V <sub>AC/DC</sub>	齐纳二极管	PUR	BK		VC22-24.4-L/S370	8049873	8047816	8050771	
		30V <sub>AC/DC</sub>	齐纳二极管	PVC	GY		VC22-24.4-L/P00	8050844	8049316	8050845	
		30V <sub>AC/DC</sub>	齐纳二极管	PVC	GY		VC22-24.4-L/P01	8050912	8047834	8050913	
	2+PE	230V <sub>AC/DC</sub>	不带抑制电路	PUR	BK		VCI21-230.0-L/S370	8050778	8047820	8050779	
		230V <sub>AC/DC</sub>	不带抑制电路	PVC	GY		VCI21-230.0-L/P00	8050853	8049320	8050854	
		230V <sub>AC/DC</sub>	不带抑制电路	PVC	GY		VCI21-230.0-L/P01	8050921	8047838	8050922	
	2+PE, PE桥接	30V <sub>AC/DC</sub>	不带抑制电路	PUR	BK		VCI22-24.1-L/S370	8050774	8047818	8050775	
		30V <sub>AC/DC</sub>	不带抑制电路	PVC	GY		VCI22-24.1-L/P00	8050849	8049318	8050850	
		30V <sub>AC/DC</sub>	不带抑制电路	PVC	GY		VCI22-24.1-L/P01	8050917	8047836	8050918	
		30V <sub>AC/DC</sub>	齐纳二极管	PUR	BK		VCI22-24.4-L/S370	8050776	8047819	8050777	
		30V <sub>AC/DC</sub>	齐纳二极管	PVC	GY		VCI22-24.4-L/P00	8050851	8049319	8050852	
		30V <sub>AC/DC</sub>	齐纳二极管	PVC	GY		VCI22-24.4-L/P01	8050919	8047837	8050920	
		2+PE, PE桥接	30V <sub>AC/DC</sub>	抑制二极管	PUR	BK		VA22-24.3-L-AL-WAS5.002/S370	8052049	8050782	8050783
			30V <sub>AC/DC</sub>	抑制二极管	PVC	GY		VA22-24.3-L-AL-WAS5.002/P00	8052209	8052225	8052226
			30V <sub>AC/DC</sub>	抑制二极管	PVC	GY		VA22-24.3-L-AL-WAS5.002/P01	8052260	8052261	8052262
3+PE	30V <sub>AC/DC</sub>	不带抑制电路	PUR	BK		VA41-24.2-L-AL-WAS5/S370	8052051	8050785	8050786		
	30V <sub>AC/DC</sub>	不带抑制电路	PVC	GY		VA41-24.2-L-AL-WAS5/P00	8052230	8052231	8052232		
	30V <sub>AC/DC</sub>	不带抑制电路	PVC	GY		VA41-24.2-L-AL-WAS5/P01	8052266	8052267	8052268		
	2+PE, PE桥接	30V <sub>AC/DC</sub>	抑制二极管	PUR	BK		VA22-24.3-L-AL-WWAS5.002/S370	8052050	8050780	8050186	
		30V <sub>AC/DC</sub>	抑制二极管	PVC	GY		VA22-24.3-L-AL-WWAS5.002/P00	8052227	8052228	8052229	
		30V <sub>AC/DC</sub>	抑制二极管	PVC	GY		VA22-24.3-L-AL-WWAS5.002/P01	8052263	8052264	8052265	
	3+PE	30V <sub>AC/DC</sub>	不带抑制电路	PUR	BK		VA41-24.2-L-AL-WWAS5/S370	8052052	8050788	8050188	
		30V <sub>AC/DC</sub>	不带抑制电路	PVC	GY		VA41-24.2-L-AL-WWAS5/P00	8052233	8052234	8052235	
		30V <sub>AC/DC</sub>	不带抑制电路	PVC	GY		VA41-24.2-L-AL-WWAS5/P01	8052269	8052270	8052271	
	2+PE	30V <sub>AC/DC</sub>	抑制二极管	PUR	BK		VB21-24.3-L-AL-WAS5.002/S370	8052053	8050790	8050791	
		30V <sub>AC/DC</sub>	抑制二极管	PVC	GY		VB21-24.3-L-AL-WAS5.002/P00	8052236	8052237	8052238	
		30V <sub>AC/DC</sub>	抑制二极管	PVC	GY		VB21-24.3-L-AL-WAS5.002/P01	8052272	8052273	8052274	
	2+PE	30V <sub>AC/DC</sub>	抑制二极管	PUR	BK		VB21-24.3-L-AL-WWAS5.002/S370	8052054	8050797	8050189	
		30V <sub>AC/DC</sub>	抑制二极管	PVC	GY		VB21-24.3-L-AL-WWAS5.002/P00	8052239	8052240	8052241	
		30V <sub>AC/DC</sub>	抑制二极管	PVC	GY		VB21-24.3-L-AL-WWAS5.002/P01	8052275	8052276	8052277	

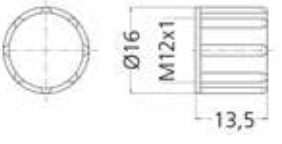

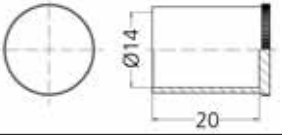

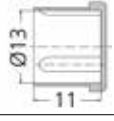

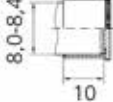

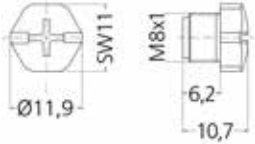

标准连接器的长度:2米,5米,或10米。中继电缆长度:1米,2米或5米。法兰面板安装的电线长度:0.5米(0.2米)。其他电缆,电线长度可按照客户要求定制。

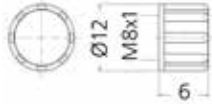

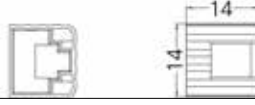

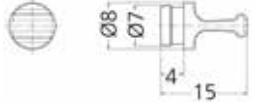

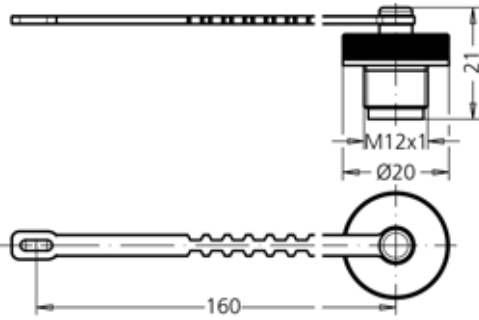

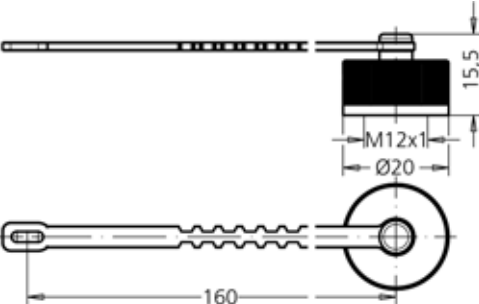

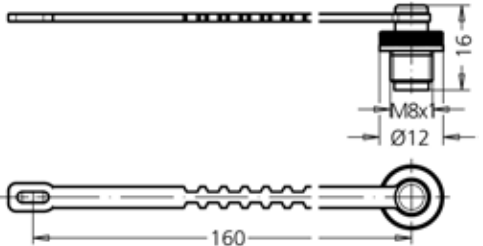
	针脚	顶端		电缆			产品描述	L /L2 = 电缆 长度		
		最大电压	电路	材料	颜色	L1[m]		2m / 1m	5m / 2m	10m / 5m
	2+PE	30V <sub>AC/DC</sub>	抑制二极管	PUR	BK		VBI21-24.3-L-AL-WAS5.002/S370	8049278	8050800	8050801
		30V <sub>AC/DC</sub>	抑制二极管	PVC	GY		VBI21-24.3-L-AL-WAS5.002/P00	8052242	8052243	8052244
		30V <sub>AC/DC</sub>	抑制二极管	PVC	GY		VBI21-24.3-L-AL-WAS5.002/P01	8052278	8052279	8052280
	2+PE	30V <sub>AC/DC</sub>	抑制二极管	PUR	BK		VBI21-24.3-L-AL-WWAS5.002/S370	8049279	8050804	8050805
		30V <sub>AC/DC</sub>	抑制二极管	PVC	GY		VBI21-24.3-L-AL-WWAS5.002/P00	8052245	8052246	8052247
		30V <sub>AC/DC</sub>	抑制二极管	PVC	GY		VBI21-24.3-L-AL-WWAS5.002/P01	8052281	8052282	8052283
	2+PE , PE桥接	30V <sub>AC/DC</sub>	齐纳二极管	PUR	BK		VC22-24.4-L-AL-WAS5.002/S370	8052055	8050807	8050190
		30V <sub>AC/DC</sub>	齐纳二极管	PVC	GY		VC22-24.4-L-AL-WAS5.002/P00	8052248	8052249	8052250
		30V <sub>AC/DC</sub>	齐纳二极管	PVC	GY		VC22-24.4-L-AL-WAS5.002/P01	8052284	8052285	8052286
	2+PE , PE桥接	30V <sub>AC/DC</sub>	齐纳二极管	PUR	BK		VC22-24.4-L-AL-WWAS5.002/S370	8052056	8050813	8050191
		30V <sub>AC/DC</sub>	齐纳二极管	PVC	GY		VC22-24.4-L-AL-WWAS5.002/P00	8052251	8052252	8052253
		30V <sub>AC/DC</sub>	齐纳二极管	PVC	GY		VC22-24.4-L-AL-WWAS5.002/P01	8052287	8052288	8052289
	2+PE , PE桥接	30V <sub>AC/DC</sub>	齐纳二极管	PUR	BK		VCI22-24.4-L-AL-WAS5.002/S370	8052057	8050810	8050192
		30V <sub>AC/DC</sub>	齐纳二极管	PVC	GY		VCI22-24.4-L-AL-WAS5.002/P00	8052254	8052255	8052256
		30V <sub>AC/DC</sub>	齐纳二极管	PVC	GY		VCI22-24.4-L-AL-WAS5.002/P01	8052290	8052291	8052292
	2+PE , PE桥接	30V <sub>AC/DC</sub>	齐纳二极管	PUR	BK		VCI22-24.4-L-AL-WWAS5.002/S370	8052058	8050816	8050193
		30V <sub>AC/DC</sub>	齐纳二极管	PVC	GY		VCI22-24.4-L-AL-WWAS5.002/P00	8052257	8052258	8052259
		30V <sub>AC/DC</sub>	齐纳二极管	PVC	GY		VCI22-24.4-L-AL-WWAS5.002/P01	8052293	8052294	8052296
	2+PE , PE桥接	24V <sub>AC/DC</sub>	不带抑制电路				VA22-24.1-WAS5.002	8055767		
		24V <sub>AC/DC</sub>	抑制二极管				VA22-24.3-WAS5.002	8055768		
		24V <sub>DC</sub>	不带抑制电路				VA41-24.2-WAS5	8055769		
		60V <sub>AC/DC</sub>	不带抑制电路				VA22-60.0-WAS5.002	8055770		

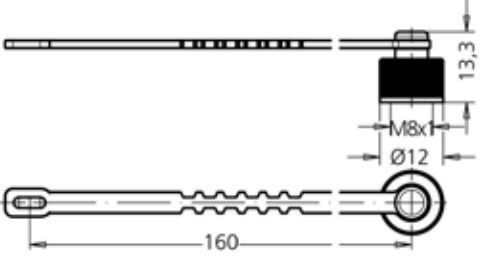

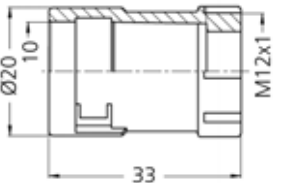
				包装设备   订货号				
				材料   颜色	1	10	100	500
		螺栓   M12 代替 M12 母头		黑色， 类似于RAL9005			8081767	8081768
				紫色， 类似于 RAL4001			8081773	8081774
				蓝色， 类似于 RAL5012			8081775	8081776
				绿色， 类似于 RAL6018			8081777	8081778
		螺帽   M12 代替 M12 公头		黄色， 类似于 RAL1021			8081751	8081752
				黑色， 类似于RAL9005			8081753	8081754
				灰色， 类似于 RAL7035			8081755	8081756
				紫色， 类似于 RAL4001			8081757	8081758
				蓝色， 类似于 RAL5012			8081759	8081760
		防尘帽   M12 代替 M12 母头 公头		黑色， 类似于RAL9005			8081763	8081764
		防尘帽   M12 代替 M12 公头		透明色			8081749	8081750
		防尘帽   Ø8mm 快插 代替 Ø 8mm快插 母头 公头		TPE   黄色， 类似于 RAL1018			8081765	8081766

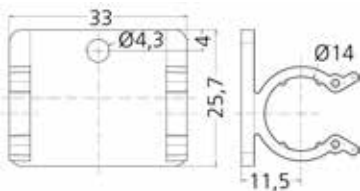

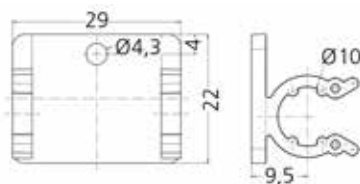





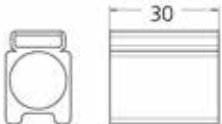

				包装设备   订货号				
				材料   颜色	1	10	100	500
		螺栓   M8 代替 M8 母头	黑色, 类似于RAL9005				8081771	8081772
		螺帽   M8 代替 M8 公头	黑色, 类似于RAL9005				8081761	8081762
		防尘帽   RJ45 代替 RJ45	塑料   透明色		8064715			
		螺栓   Ø8mm 快插 代替 Ø8mm快插 母头	黑色, 类似于RAL9005				8081769	8081770
		专属螺栓 代替 M12 母头	黑色, 类似于RAL9005		8048568			
		专属螺帽 代替 M12 公头	黑色, 类似于RAL9005		8048569			

		包装设备   订货号				
		材料   颜色	1	5	10	100
		专属螺栓 代替 M8 母头	黑色, 类似于RAL9005 8048567			
		专属螺帽 代替 M8 公头	8048566			
		转接器   M12	黑色, 类似于RAL9005	8081747		
		保护套管 50m	黑色, 类似于RAL9005 8081621			
		装配-夹   M12   1x夹	聚甲醛	8047660		
		装配-装置   M12   夹+ 螺丝 M4x8	聚甲醛	8047664		
		装配-夹   M8   1x夹	聚甲醛	8047658		
		装配-装置   M8   夹+ 螺丝 M4x8	聚甲醛	8047663		

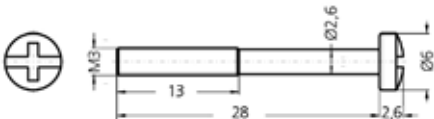
				包装设备   订货号				
				材料   颜色	1	10	100	500
		<p>装配-装置   S89   2个装载板+4个 M4x25螺丝 +4个 M4螺帽</p>	<p>PA, BK</p>	<p>8036078</p>				
		<p>墙壁支架用于工业以太网适配器   订货号 8065952 8065950及 8065951</p>	<p>塑料</p>	<p>8065953</p>				
		<p>防护-夹   M12   压力下免受意外断开</p>	<p>PA, BK   黑色, 类似于RAL9005</p>	<p>8040501</p>				
		<p>防护-夹   M8   压力下免受意外断开</p>	<p>PA, BK   黑色, 类似于RAL9005</p>	<p>8040691</p>				

				包装设备   订货号				
				材料   颜色	1	10	100	500
		标签   I/O-分线盒 被动   I/O-分线盒 逻辑 M8					8011349	
		标签   I/O-分线盒 被动   I/O-分线盒 逻辑 M12		白色, 类似于 RAL9002				8015002
		配件系列   I/O-分线盒 被动   I/O-分线盒 逻辑   M8   10 x 标签, 2 x 螺栓 8015075 M8					8087214	
		配件系列   I/O-分线盒 被动   M12   10 x 标签, 2 x 螺栓 8000004 M12					8087215	
		标签   阀连接器 AA,B,BI,C,CI		白色, 类似于 RAL9002				8047109
		标签   阀连接器 A		白色, 类似于 RAL9002				8047110
		标签载体 Ø 3,5...6,0 mm		PVC			8000052	
		标签载体 Ø 6,0...10,0 mm		PVC			8000060	

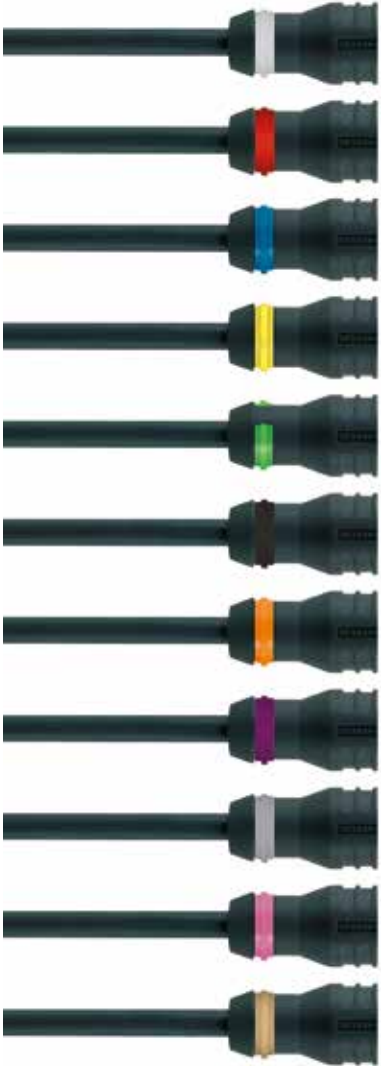
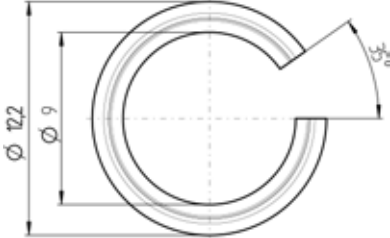

				包装设备   订货号				
				材料   颜色	1	10	100	500
		标签载体	Ø 3,5...6,0 mm	热塑性塑料ESC (无卤素)	8000091			
		标签载体	Ø 6,0...9,0 mm	热塑性塑料ESC (无卤素)	8000092			
		剥线器   用于PUR外护套电缆纵向切的剥线器			8066217			
		电缆剥离工具   自动剥线工具用于PUR无卤,高弹性PUR-U-E, PUR- PUR/PVC-,PVC, 屏蔽及不屏蔽, 以及多股电缆 4,40 – 7,00mm			8066215			
		电缆剥离工具   自动剥线工具用于PUR无卤,高弹性PUR-U-E, PUR- PUR/PVC-,PVC, 屏蔽及不屏蔽, 以及多股电缆 3,20 – 4,40mm			8066216			
		固定螺丝   不锈钢螺钉, 适合阀连接器A、B、BI型		V4A	8060907			
								
		法兰备用螺母 法兰连接 M8   PFKS,PFS A/F10		合金, 铜锌, 镀镍	8004923			
		法兰备用螺母 法兰连接 M8   PFSF A/F10		合金, 铜锌, 镀镍	8004971			
		法兰备用螺母 法兰连接 M12   FFSF A/F16		合金, 铜锌, 镀镍	8004930			

			包装设备   订货号				
			材料   颜色	1	10	100	500
		法兰备用螺母 法兰连接 M12   FKD, FSD PG9 A/F17	合金, 铜锌, 镀镍	8004874			
		法兰备用螺母 法兰连接 M12   FKD, FSD M16 A/F17	合金, 铜锌, 镀镍	8027491			
		法兰备用螺母 法兰连接 M12   PG9 A/F18	合金, 铜锌, 镀镍	8004913			
		法兰备用螺母 法兰连接 M12   M16x1,5 A/F19	合金, 铜锌, 镀镍	8029359			
		法兰备用螺母 法兰连接 M12   FKD, FSD, M20 A/F22	合金, 铜锌, 镀镍	8027492			
		法兰备用螺母 法兰连接 M12   M20x1,5 A/F24	合金, 铜锌, 镀镍	8029360			
		密封件   现场接线连接器   M12   适用于M12现场接线连接器的密封件	黑色, 类似于RAL9005	8061922			
		焊料标签   M16x1.5   用于法兰外壳接地	合金, 铜锌, 镀镍	8036043			
		焊料标签   M20x1,5   用于法兰外壳接地	合金, 铜锌, 镀镍	8036044			

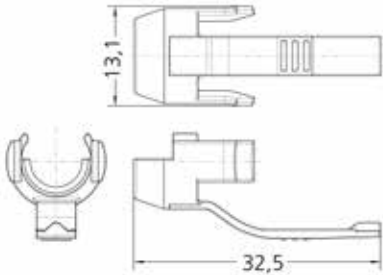
		包装设备   订货号					
		材料   颜色	1	10	100	500	
		标记环 $\varnothing$ 9mm   “彩色编码的电缆和连接器 ( M12, M12屏蔽, RJ45, 带电缆包覆成型插座连接器 : FKFDSY, M8屏蔽 )	聚甲醛   白色, 类似于 RAL9002				8063523
			聚甲醛   红色, 类似于 RAL3020				8063524
		聚甲醛   蓝色, 类似于 RAL5012				8063525	
		聚甲醛   黄色, 类似于 RAL1018				8063526	
		聚甲醛   绿色, 类似于 RAL6018				8063527	
		聚甲醛   黑色, 类似于 RAL9004				8063528	
		聚甲醛   橘色, 类似于 RAL2008				8063529	
		聚甲醛   紫色, 类似于 RAL4006				8063530	
		聚甲醛   灰色, 类似于 RAL7035				8063531	
		聚甲醛   粉色, 类似于 RAL4003				8063532	
		聚甲醛   沙黄, 类似于 RAL1002				8063533	

		包装设备   订货号					
		材料   颜色	1	10	100	500	
		RJ45未锁定的夹装	聚甲醛   红色， 类似于 RAL3020	8071939			
		RJ45未锁定的夹装	聚甲醛   橘色， 类似于 RAL2008	8071944			
		RJ45未锁定的夹装	聚甲醛   黄色， 类似于 RAL1018	8071941			
		RJ45未锁定的夹装	聚甲醛   沙黄， 类似于 RAL1002	8071948			
		RJ45未锁定的夹装	聚甲醛   绿色， 类似于 RAL6018	8071942			
		RJ45未锁定的夹装	聚甲醛   蓝色， 类似于 RAL5012	8071940			
		RJ45未锁定的夹装	聚甲醛   紫色， 类似于 RAL4006	8071945			
		RJ45未锁定的夹装	聚甲醛   粉色， 类似于 RAL4003	8071947			
		RJ45未锁定的夹装	聚甲醛   灰色， 类似于 RAL7035	8071946			
		RJ45未锁定的夹装	聚甲醛   白色， 类似于 RAL9002	8071938			
		RJ45未锁定的夹装	聚甲醛   黑色， 类似于 RAL9004	8071943			

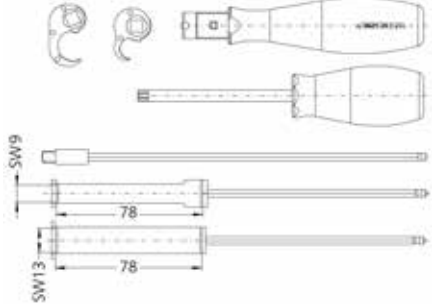

				包装设备   订货号				
				材料   颜色	1	10	100	500
		<p>扭矩扳手组   扭矩扳手组完全适用于M8, M12 (滚花, 六角螺母)</p>	8055431					
		<p>食品饮料加工行业   转接   转换头A/F14适用于食品&amp;包装卫生设计的M12 (单独)</p>	8063392					



P00	P01®	P01BK®	S370®	S370GY®	S7400® robotic	S570®	S400® easystrip		
PVC	PVC	PVC	PUR, 不含卤素	PUR, 不含卤素	PUR, 不含卤素	PUR, 不含卤素	PUR, 不含卤素		护套
PVC	PVC	PVC	PP, 不含卤素	PP, 不含卤素	PP, 不含卤素	PP, 不含卤素	PP, 不含卤素		绝缘
RAL 7040	RAL 7040	RAL 9005	RAL 9005	RAL 7040	RAL 2003	RAL 9005	RAL 9005		外护套颜色 (类似于)
★★★★	★★★★	★★★★	★★★★	★★★★	★★★★	★★★★	★★★★		机械及设备制造
★★	★★	★★	★★★★	★★★★	★★★★	★★★★	★★★★		汽车工业
★	★	★	★★★★	★★★★	★★★★	★★★★	★★★★		机器人技术
★★★★	★★★★	★★★★	★	★	★	★	★		食品和饮料工业
★★★★	★★★★	★★★★	★	★	★	★	★		包装和灌装系统
★★	★★	★★	★★	★★	★★	★★	★★		建筑安装
★★	★★	★★	★★★★	★★★★	★★★★	★★★★	★★★★		风力发电
★★★★	★★★★	★★★★	★★★★	★★★★	★★★★	★★★★	★★★★		阻燃
★★	★★	★★	★★★★	★★★★	★★★★	★★★★	★★★★		耐油性
★	★	★	★★★★	★★★★	★★★★	★★★★	★★★★		焊接现场抗干扰性
★	★	★	★★★★	★★★★	★★★★	★★★★	★★★★		拖链能力
			★★★	★★★	★★★★	★★★	★★★★		扭转能力
★	★	★	★	★	★	★	★		酸碱抗性
★★	★★	★★	★★	★★	★★	★★	★★		耐海水
★	★	★	★★★★	★★★★	★★★★	★★★★	★★★★		抗臭氧和紫外线能力
★★	★★	★★	★★	★★	★★	★★	★★		水解强度
★★	★★	★★	★★	★★	★★	★★	★★		微生物浓度
≤300V	≤300V	≤300V	≤300V	≤300V	≤300V	≤300V	≤300V		额定电压
10xØ	10xØ	10xØ	10xØ	10xØ	10xØ	10xØ	10xØ		弯曲强度 (重复)
5xØ	5xØ	5xØ	5xØ	5xØ	5xØ	5xØ	5xØ		弯曲强度 (单次)
0°C...+80°C	0°C...+80°C	0°C...+80°C	-30°C...+90°C	-30°C...+90°C	-30°C...+90°C	-30°C...+90°C	-30°C...+90°C		温度范围 (重复)
-25°C...+80°C	-25°C...+80°C	-25°C...+80°C	-40°C...+90°C	-40°C...+90°C	-40°C...+90°C	-40°C...+90°C	-40°C...+90°C		温度范围 (单次)
可选	可选	可选	可选	可选	无	无	无		屏蔽
✓	✓	✓	✓	✓	✓	✓	✓		ROHS
	✓	✓	✓	✓	✓	✓	✓		UL and/or CSA
✓	✓	✓	✓	✓	✓	✓	✓		GOST
✓	✓	✓							ECOLAB
AL   FB   V	AL   FB   V	AL   V	AL   V	AL   V	AL	AL	AL		ESCHA 产品线





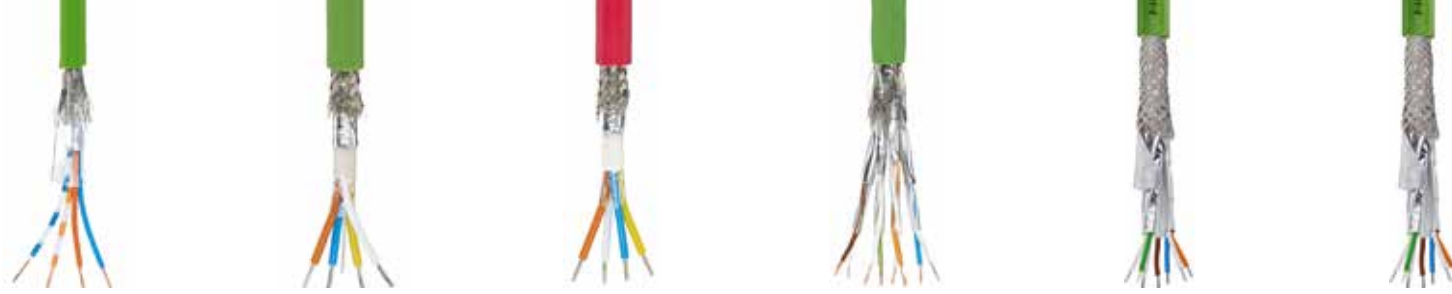

S3930	S2430	Cat5e   S2171®	Cat5e   S5058®	Cat5e   S5059®		
TPE, 不含卤素	PTFE(5Y)	外部 PUR11Y, 内部 FRNC	外部 PUR11Y, 内部 FRNC	外部 PUR11Y, 内部 FRNC		护套
TPE, 不含卤素	PTFE(5Y)	PE2Y, 不含卤素	PE2Y, 不含卤素	PE2Y, 不含卤素		绝缘
RAL 7035	RAL 9003	RAL 6018	BK, 红色竖条纹	BK, 红色竖条纹		外护套颜色 (类似于)
★	★	★★★★	★★★★	★★★★		机械及设备制造
★★★★	★★	★★★★	★★★★	★★★★		汽车工业
★★★★	★★	★★	★	★		机器人技术
★★★★	★★	★	★	★		食品和饮料工业
★★★★	★★	★	★	★		包装和灌装系统
★★	★★	★★★★	★★★★	★★★★		建筑安装
★★	★★★★	★★★★	★★★★	★★★★		风力发电
★★★★	★★★★	★★★★	★★★★	★★★★		阻燃
★★	★★★★	★★★★	★★★★	★★★★		耐油性
★	★★	★	★	★		焊接现场抗干扰性
★★	★★	★★★★	★★★★	★★★★		拖链能力
		★	★	★		扭转能力
★★★★	★★★★					酸碱抗性
★★★★	★★★★	★★	★★	★★		耐海水
	★★★★	★★	★★	★★		抗臭氧和紫外线能力
★★★★	★★★★	★★	★★	★★		水解强度
★★★★	★★★★	★★	★★	★★		微生物浓度
≤250V <sub>Ac</sub>	≤250V	600V (额定电压)	300V (额定电压)	300V (额定电压)		额定电压
10xØ	10xØ	8xØ	8xØ	15xØ		弯曲强度 (重复)
5xØ	5xØ	4xØ	6xØ	8xØ		弯曲强度 (单次)
-25°C...+105°C	n/s	-30°C...+70°C	-30°C...+70°C	-30°C...+70°C		温度范围 (重复)
-40°C...+105°C	-190°C...+260°C	-40°C...+75°C	-40°C...+80°C	-40°C...+80°C		温度范围 (单次)
无	可选	是	是	是		屏蔽
✓	✓	✓	✓	✓		ROHS
		✓	✓	✓		UL and/or CSA
✓	✓	✓	✓	✓		GOST
✓						ECOLAB
FB	HT	IE   Profinet	IE   EtherCAT P	IE   EtherCAT P		ESCHA 产品线

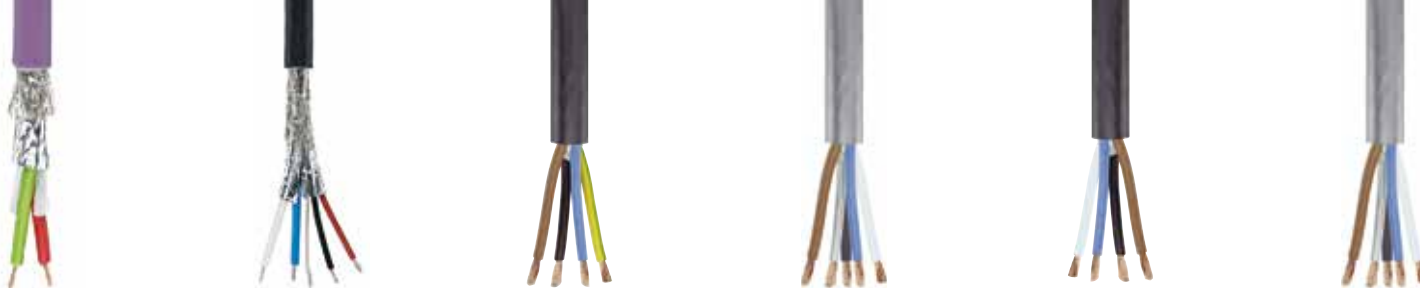



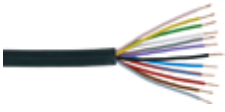













Cat5   S3400®	Cat5e   S5100®	Cat5e   S3800®	Cat7   S3500®	Cat7   S4030®	Cat6   S4031®		
PUR, F45052-F5100	PUR	外部 PUR11Y, 内部 FRNC	PUR11Y	PUR	PUR		护套
PP	PE	PE2Y, 不含卤素	PE02Y, 泡沫	Foam-Skin Polyolefin	Foam-Skin Polyolefin		绝缘
RAL6018	RAL6018	RAL3020	RAL6018	RAL6018	RAL6018		外护套颜色 (类似于)
★	★★★★	★	★	★★	★★		机械及设备制造
★★★★	★★★★	★★★★	★★★★	★★★★	★★★★		汽车工业
★★	★★★★	★★	★★	★★★	★★★		机器人技术
★	★	★	★	★	★		食品和饮料工业
★	★	★	★	★	★		包装和灌装系统
★★★★	★★★★	★★★★	★★★★	★★	★★		建筑安装
★★★★	★★★★	★★★★	★★★★	★★★★	★★★★		风力发电
★★	★★★★	★★★★	★★★★	★★★★	★★★★		阻燃
★★★★	★★★★	★★★★	★★★★	★★★★	★★★★		耐油性
★	★	★	★	★	★		焊接现场抗干扰性
★★★★	★★★★	★★★★	★★★★	★	★★★★		拖链能力
★	★★★★	★	★	★★★★	★		扭转能力
							酸碱抗性
★★	★★	★★	★★	★★	★★		耐海水
★★	★★	★★	★★	★★	★★		抗臭氧和紫外线能力
★★	★★	★★	★★	★★	★★		水解强度
★★	★★	★★	★★	★★	★★		微生物浓度
30V (额定电压)	600V (额定电压)	600V (额定电压)	30V (额定电压)	125V	100V		额定电压
7.5xØ	10xØ	8xØ	10xØ	15xØ	7.5xØ		弯曲强度 (重复)
4xØ	5xØ	4xØ	5xØ	8xØ	4xØ		弯曲强度 (单次)
-40°C...+80°C	-20°C...+80°C	-40°C...+80°C	-40°C...+80°C	-30°C...+70°C	-30°C...+70°C		温度范围 (重复)
-40°C...+80°C	-40°C...+80°C	-40°C...+80°C	-20°C...+60°C	-40°C...+80°C	-40°C...+80°C		温度范围 (单次)
是	是	是	是	是	是		屏蔽
✓	✓	✓	✓	✓	✓		ROHS
✓	✓	✓	✓	✓	✓		UL and/or CSA
✓	✓	✓	✓	✓	✓		GOST
							ECOLAB
IE   EtherCAT	Industrial Ethernet	IE   Sercos®	Industrial Ethernet	Industrial Ethernet	Industrial Ethernet		ESCHA 产品线





S 1800®	S 2800®	S 5015®	S 5015GY®	S 5025®	S 5025GY®		
PUR	PUR	PUR, 不含卤素	PUR, 不含卤素	PUR, 不含卤素	PUR, 不含卤素		护套
PE, 泡沫	信号: PE, 电源: PP	PP, 不含卤素	PP, 不含卤素	PP, 不含卤素	PP, 不含卤素		绝缘
RAL4001	RAL9005	RAL9005	RAL7040	RAL9005	RAL7040		外护套颜色 (类似于)
**	**	****	****	****	****		机械及设备制造
****	****	****	****	****	****		汽车工业
**	**	*	*	*	*		机器人技术
*	*	*	*	*	*		食品和饮料工业
*	*	*	*	*	*		包装和灌装系统
****	****	**	**	**	**		建筑安装
****	****	****	****	****	****		风力发电
****	****	****	****	****	****		阻燃
**	**	****	****	****	****		耐油性
*	*	****	****	****	****		焊接现场抗干扰性
**	***	****	****	****	****		拖链能力
*	*	*	*	*	*		扭转能力
		**	**	**	**		酸碱抗性
**	**	**	**	**	**		耐海水
**	****	****	****	****	****		抗臭氧和紫外线能力
**	**	**	**	**	**		水解强度
**	**	**	**	**	**		微生物浓度
300V	≤300V	VDE U <sub>0</sub> /U: 600V/1.000V	VDE U <sub>0</sub> /U: 600V/1.000V	VDE U <sub>0</sub> /U: 600V/1.000V	VDE U <sub>0</sub> /U: 600V/1.000V		额定电压
10xØ	10xØ	7.5xØ	7.5xØ	10xØ	10xØ		弯曲强度 (重复)
5xØ	5xØ	4 xØ	4 xØ	4 xØ	4 xØ		弯曲强度 (单次)
-25°C...+80°C	-25°C...+80°C	-40°C...+90°C	-40°C...+90°C	-40°C...+90°C	-40°C...+90°C		温度范围 (重复)
-50°C...+80°C	-50°C...+80°C	-50°C...+90°C	-50°C...+90°C	-50°C...+90°C	-50°C...+90°C		温度范围 (单次)
是	是	无	无	无	无		屏蔽
✓	✓	✓	✓	✓	✓		ROHS
✓	✓	✓	✓	✓	✓		UL and/or CSA
✓	✓	✓	✓	✓	✓		GOST
							ECOLAB
Profibus	CANopen/DeviceNet	POWER	POWER	POWER	POWER		ESCHA 产品线

	电线	电线颜色	导体结构	ø [mm]	产品描述	L=100m
	3	棕, 蓝, 黑	32 x 0.10 mm	4,60	LiF9Y11YFHF 3x0,25 mm <sup>2</sup>	8058484
	4	棕, 白, 蓝, 黑	32 x 0.10 mm	4,80	LiF9YH-11YH 4x0,25 (32x0,10)	8069722
	3	棕, 蓝, 黑	42 x 0.10 mm	4,80	LiF9Y11YFHF 3x0,34 mm <sup>2</sup>	8058485
	4	棕, 白, 蓝, 黑	42 x 0.10 mm	5,20	LiF9Y11YFHF 4x0,34 mm <sup>2</sup>	8057309
	4+PE	棕, 白, 蓝, 黑, 绿黄	42 x 0.10 mm	5,60	LiF9Y11YFHF 4x0,34+1x0,34 mm <sup>2</sup>	8058487
	3	棕, 蓝, 黑	32 x 0.10 mm	4,00	LiF9YH-11YH 3x0,25	8058490
	4	棕, 白, 蓝, 黑	32 x 0.10 mm	4,30	LiF9YH-11YH 4x0,25	8058491
	5	棕, 白, 蓝, 黑, 灰	32 x 0.10 mm	4,70	LiF9YH-11YH 5x0,25	8058492
	3	棕, 蓝, 黑	42 x 0.10 mm	4,30	LiF9YH-11YH 3x0,34	8046603
	4	棕, 白, 蓝, 黑	42 x 0.10 mm	4,70	LiF9YH-11YH 4x0,34	8045519
	4+PE	棕, 白, 蓝, 黑, 绿黄	42 x 0.10 mm	5,20	LiF9YH-11YH 4x0,34+1x0,34	8048725
	5	棕, 白, 蓝, 黑, 灰	42 x 0.10 mm	5,20	LiF9YH-11YH 5x0,34	8047757
	8	白, 棕, 绿, 黄, 灰, 粉红, 蓝, 红	32 x 0.10 mm	5,90	LiF9YH11YH 8x0,25	8055605
	12	棕, 蓝, 白, 绿, 粉红, 黄, 黑, 灰, 红, 紫, 灰粉红, 红蓝	18 x 0.10 mm	5,60	Li9YH11YH 12x0,14	8055606
	3	棕, 蓝, 黑	32 x 0.10 mm	4,00	LiF9YH-11YH 3x0,25	8058493
	4	棕, 白, 蓝, 黑	32 x 0.10 mm	4,30	LiF9YH-11YH 4x0,25 (32x0,10)	8079702
	3	棕, 蓝, 黑	42 x 0.10 mm	4,30	LiF9YH-11YH 3x0,34	8058494
	4	棕, 白, 蓝, 黑	42 x 0.10 mm	4,70	LiF9YH-11YH 4x0,34	8058495
	4+PE	棕, 白, 蓝, 黑, 绿黄	42 x 0.10 mm	5,20	LiF9YH-11YH 4x0,34+1x0,34	8058496
	3	棕, 蓝, 黑	42 x 0.10 mm	4,80	LiF9YC11YFHF 3x0,34	8058488
	4	棕, 白, 蓝, 黑	42 x 0.10 mm	5,10	LiF9YC11YFHF 4x0,34	8047431
	5	棕, 白, 蓝, 黑, 灰	42 x 0.10 mm	5,60	LiF9YC11YFHF sw 5x0,34	8046513
	8	白, 棕, 绿, 黄, 灰, 粉红, 蓝, 红	32 x 0.10 mm	6,30	LiF9YHC11YH 8x0,25	8048963
	12	棕, 蓝, 白, 绿, 粉红, 黄, 黑, 灰, 红, 紫, 灰粉红, 红蓝	18 x 0.10 mm	6,00	Li9YHC11YH 12x0,14	8058489
	3	棕, 蓝, 黑	14 x 0.15 mm	4,00	LiYY-OB 3x0,25 (14x0,15)	8058513
	4	棕, 白, 蓝, 黑	14 x 0.15 mm	4,20	LiYY-OB 4x0,25 (14x0,15)	8056855
	5	棕, 白, 蓝, 黑, 灰	14 x 0.15 mm	4,50	LiYY-OB 5x0,25 (14x0,15)	8058514
	3	棕, 蓝, 黑	19 x 0.15 mm	4,20	LiYY-OB 3x0,34 (19x0,15)	8058515
	4	棕, 白, 蓝, 黑	19 x 0.15 mm	4,50	LiYY-OB 4x0,34 (19x0,15)	8057030
	4+PE	棕, 白, 蓝, 黑, 绿黄	19 x 0.15 mm	4,90	LiYY-JB 4x0,34+1x0,34 (19x0,15)	8058516
	5	棕, 白, 蓝, 黑, 灰	19 x 0.15 mm	4,90	LiYY-OB 5x0,34 (19x0,15)	8058517
	8	白, 棕, 绿, 黄, 灰, 粉红, 蓝, 红	14 x 0.15 mm	5,70	LiYY-OB 8x0,25 (14x0,15)	8058519
	12	棕, 蓝, 白, 绿, 粉红, 黄, 黑, 灰, 红, 紫, 灰粉红, 红蓝	18 x 0.10 mm	6,10	LiYY-OB 12x0,14 (18x0,10)	8058520

	电线	电线颜色	导体结构	ø [mm]	产品描述	L=100m
 PVC, 控制线, 屏蔽防护, P00	3	棕, 蓝, 黑	14 x 0.15 mm	4,60	LiYCY-OB 3x0,25 (14x0,15)	8058497
	4	棕, 白, 蓝, 黑	14 x 0.15 mm	4,90	LiYCY-OB 4x0,25 (14x0,15)	8058498
	5	棕, 白, 蓝, 黑, 灰	14 x 0.15 mm	5,30	LiYCY-OB 5x0,25 (14x0,15)	8058504
	3	棕, 蓝, 黑	19 x 0.15 mm	4,80	LiYCY-OB 3x0,34 (19x0,15)	8058502
	4	棕, 白, 蓝, 黑	19 x 0.15 mm	5,10	LiYCY-OB 4x0,34 (19x0,15)	8058503
	5	棕, 白, 蓝, 黑, 灰	19 x 0.15 mm	5,50	LiYCY-OB 5x0,34 (19x0,15)	8058504
	8	白, 棕, 绿, 黄, 灰, 粉红, 蓝, 红	14 x 0.15 mm	6,70	LiYCY-OB 8x0,25 (14x0,15)	8042487
	12	棕, 蓝, 白, 绿, 粉红, 黄, 黑, 灰, 红, 紫, 灰粉红, 红蓝	18 x 0.10 mm	6,60	LiYCY-OB 12x0,14 (18x0,10)	8058505
 PVC, 控制线, P01	3	棕, 蓝, 黑	14 x 0.15 mm	4,30	LiYY-OB 3x 0,25	8058521
	4	棕, 白, 蓝, 黑	14 x 0.15 mm	4,70	LiYY-OB 4x0,25	8058522
	3	棕, 蓝, 黑	19 x 0.15 mm	4,60	LiYY-OB 3x0,34mm <sup>2</sup>	8058523
	4	棕, 白, 蓝, 黑	19 x 0.15 mm	4,90	LiYY-OB 4x0,34mm <sup>2</sup>	8058524
	4+PE	棕, 白, 蓝, 黑, 绿黄	19 x 0.15 mm	5,30	LiYY-JB 4x0,34+1x0,34mm <sup>2</sup>	8058525
	5	棕, 白, 蓝, 黑, 灰	19 x 0.15 mm	5,30	LiYY-OB 5x0,34mm <sup>2</sup>	8058526
	8	白, 棕, 绿, 黄, 灰, 粉红, 蓝, 红	14 x 0.15 mm	6,20	LiYY-OB 8x0,25	8058527
	12	棕, 蓝, 白, 绿, 粉红, 黄, 黑, 灰, 红, 紫, 灰粉红, 红蓝	18 x 0.10 mm	6,10	LiYY-OB 12x0,14	8058528
 PVC, 控制线, 屏蔽防护, P01	3	棕, 蓝, 黑	14 x 0.15 mm	4,80	LiYCY-OB 3x0,25	8058506
	4	棕, 白, 蓝, 黑	14 x 0.15 mm	5,10	LiYCY-OB 4x0,25	8058507
	3	棕, 蓝, 黑	19 x 0.15 mm	5,00	LiYCY-OB 3x0,34	8058508
	4	棕, 白, 蓝, 黑	19 x 0.15 mm	5,30	LiYCY-OB 4x0,34	8058509
	5	棕, 白, 蓝, 黑, 灰	19 x 0.15 mm	5,90	LiYCY-OB 5x0,34	8058510
	8	白, 棕, 绿, 黄, 灰, 粉红, 蓝, 红	14 x 0.15 mm	6,70	LiYCY-OB 8x0,25	8058511
	12	棕, 蓝, 白, 绿, 粉红, 黄, 黑, 灰, 红, 紫, 灰粉红, 红蓝	18 x 0.10 mm	6,60	LiYCY-OB 12x0,14	8058512
	 PVC, 控制线, P01BK	3	棕, 蓝, 黑	14 x 0.15 mm	4,30	LiYY-OB 3x0,25
4		棕, 白, 蓝, 黑	14 x 0.15 mm	4,70	LiYY-OB 4x0,25	8082411
3		棕, 蓝, 黑	19 x 0.15 mm	4,60	LiYY-OB 3x0,34	8082412
4		棕, 白, 蓝, 黑	19 x 0.15 mm	4,90	LiYY-OB 4x0,34	8082413
4+PE		棕, 白, 蓝, 黑, 绿黄	19 x 0.15 mm	5,30	LiYY-JB 4x0,34+1x0,34mm <sup>2</sup>	8082414

	电线	电线颜色	导体结构	ø [mm]	产品描述	L=100m	
	PUR, 控制线, S400	3	棕, 蓝, 黑	32 x 0.10 mm	4,15	LiF9YH-11YH 3x0,25	8073161
		3	棕, 蓝, 黑	42 x 0.10 mm	4,30	LiF9YH-11YH 3x0,34	8073032
		4	棕, 白, 蓝, 黑	42 x 0.10 mm	4,40	LiF9YH-11YH 4x0,25	8073162
		4	棕, 白, 蓝, 黑	42 x 0.10 mm	4,70	LiF9YH-11YH 4x0,34	8073033
		5	棕, 白, 蓝, 黑, 灰	32 x 0.10 mm	4,80	LiF9YH-11YH 5x0,25	8073163
		5	棕, 白, 蓝, 黑, 灰	42 x 0.10 mm	5,20	LiF9YH-11YH 5x0,34	8073164
		5	棕, 白, 蓝, 黑, 绿黄	42 x 0.10 mm	5,20	LiF9YH-11YH 4x0,34+1x0,34	8073165
		8	白, 棕, 绿, 黄, 灰, 粉红, 蓝, 红	32 x 0.10 mm	6,00	LiF9YH-11YH 8x0,25	8073166
	12	棕, 蓝, 白, 绿, 粉红, 黄, 黑, 灰, 红, 紫, 灰粉红, 红蓝	18 x 0.10 mm	5,60	LiF9YH-11YH 12x0,14	8073167	
	PUR, 控制线, S570	5	棕, 白, 蓝, 黑, 灰	18 x 0,10 mm (0,14 mm <sup>2</sup> ), 42 x 0,10 mm (0,34 mm <sup>2</sup> )	4,90	LiF9YH-11YH 3x0,14+2x0,34 UL/CSA 20549	8088696
	TPE, 控制线, 耐洗涤剂, S3930	4	棕, 白, 蓝, 黑	42 x 0.10 mm	4,60	SU (4 Li12Y 0,34) 14Y 3139D	8058694
	PTFE, 控制线, 耐高温, S2430	5	棕, 白, 蓝, 黑, 灰	7 x 0.254 mm	3,80	Li5Y5Y-OB 5xAWG22	8037921
	PUR, 总线电缆, 工业以太网, 屏蔽防 护, S2171, Cat5e	4	黄/橙; 白/蓝	7 x 0.25 mm	6,50	2YH(ST)C11Y2x2xAWG22	8036284
	PUR, 总线电缆, 工业以太网, 屏蔽防 护, S5100, Cat5e	4	黄/橙; 白/蓝	7 x 0.25 mm	6,50	2Y(ST)C11Y4xAWG22	8088017
	PUR, 总线电缆, 工业以太网, 屏蔽防 护, S3400	4	白蓝/蓝; 白橙/橙	19 x 0.10 mm	4,80	LI9YC(ST)11Y 1x4xAWG26, UL-Style 20963	8055896
	PUR, 总线电缆, 工业以太网, 屏蔽防 护, S5058, Cat5e	4	橙, 白, 蓝, 黄	7 x 0.25 mm	6,50	Cat5e flex Li2YH(ST)C-11Y-OB 4xAWG22	8089302
	PUR, 总线电缆, 工业以太网, 屏蔽防 护, S5059, Cat5e	4	黄/橙; 白/蓝	7 x 0,22 mm	5,20	Cat5e flex Li2YH(ST)C-11Y-OB 4xAWG24	8089303
	PUR, 总线电缆, 工业以太网, 屏蔽防 护, S4030	8	白/蓝; 白/橙; 白/绿; 白/棕	7 x 0.20 mm	9,40	ETHERLINE TORSION Cat. 7 (2170481)	8064607
	PUR, 总线电缆, 工业以太网, 屏蔽防 护, S4031	8	白/蓝; 白/橙; 白/绿; 白/棕	19 x 0.102 mm	7,80	Etherline FD P CAT.6 4x2xAWG26/19 2170488	8064606
	PUR, 总线电缆, 工业以太网, 屏蔽防 护, S3500, Cat7	8	白/橙; 白/绿; 白/棕; 白/蓝	7 x 0.16 mm	6,40	LI02YSC11Y 4x2x0,14 PIMF FRNC GN Cat. 7	8053361
	PUR, 总线电缆, 工业 以太网, Sercos, 屏蔽 防护, S3800, Cat5e	4	橙, 白, 蓝, 黄	7 x 0.254 mm	6,50	2YH(ST)C11Y 1x4xAWG22 ws,ge,bl,or	8055782
	PUR, 总线电缆, PROFIBUS, S1800	2	红, 绿	19 x 0.15 mm	7,60	LI02YS-STCB11Y 1x2x0,34	8043857
	PUR, 总线电缆, CANopen/DeviceNet, S2800	4	白, 蓝, 红, 黑,	19 x 0.13mm (0.25mm <sup>2</sup> ), 19 x 0.15mm (0.34mm <sup>2</sup> )	6,90	LIV02YS(ST)-CB11Y (2x0,25)+(2x0,34)	8047939



	电线	电线颜色	导体结构	ø [mm]	产品描述	L=100m
	2+PE	棕, 蓝, 绿黄	优越并达到标准 class 6	8,50	LiF9YH-11YH 3G1,5 S5015	8064082
	4	棕, 白, 蓝, 黑	优越并达到标准 class 6	9,60	LiF9YH-11YH 4x1,5 S5015	8064083
	3+PE	灰, 黑, 棕, 绿黄	优越并达到标准 class 6	9,60	LiF9YH-11YH 4G1,5 S5015	8070663
	4+PE	蓝, 灰, 棕, 黑, 绿黄	优越并达到标准 class 6	9,90	PUR/PP A 5G1,5 BK	8083056
	4+FE	棕, 白, 蓝, 黑, 灰	优越并达到标准 class 6	9,90	LiF9YH-11YH 5G1,5 S5015	8094391
	4	棕, 白, 蓝, 黑	优越并达到标准 class 6	11,00	LiF9YH-11YH 4x2,5 S5025	8064084
	4+PE	蓝, 灰, 棕, 黑, 绿黄	优越并达到标准 class 6	11,70	PUR/PP A 5G2,5 BK	8083057
	4+FE	棕, 白, 蓝, 黑, 灰	优越并达到标准 class 6	11,70	LiF9YH-11YH 5G1,5 S5015	8094392

## 技术信息

### 连接器综合信息

机械规格的不同要求对连接器的应用带来了限制。以下将说明我们产品制造和测试所遵循的相关标准和规范。

IEC 61984; DIN EN 61984:2012-03; VDE 0627:2012-03 |  
连接器 – 安全需求和测试

本国际标准适用于额定电压为1000V ~ 1500V或额定电流为125A的连接器和连接设备，用于连接机械或测量、仪表或控制回路中的组件或元件，并考虑了安全因素。它也适用于和信息处理单元上的连接器和连接设备。

IEC 60664; DIN EN 60664-1:2008-01; VDE 0110-1:2008-01 |  
电气设备的绝缘配合

本国际标准是实现隔离配合的基本安全标准。它包含确定电气设备（如连接器）的空气距离、爬电距离和固体绝缘所需的数据。这是在考虑到预期使用寿命过程中所暴露的微环境条件和其他负载下实现的。此电压测试过程包括了隔离配合。

IEC 60512; DIN EN 60512:2012-10; VDE 0687-512:2012-10 |  
电子设备用连接器 – 试验和测量

本标准确定了机电元件(如连接器)的测量和测试过程。该标准非常全面，共包含9个部分，其中描述了所有电气、机械和气候测试。此外，该标准还包括焊接能力、密度、屏蔽和电缆拉出支架的测试。

IEC 60529; DIN EN 60529:2014-09; VDE 0470-1:2014-09 |  
防护罩提供的防护等级(IP代码)

本标准确定了电气设备(如连接器)外壳保护等级分类的设计、要求和试验。从而对危险部位的防护、固体异物的防护和水的防护进行了评价。保护程度由IP代码指定。

IEC 60068; DIN EN 60068:2015-09; VDE 0468:2015-09 |  
环境试验

本标准包含环境试验和试验精度的基本规定。这个测试过程是为了追踪在可操作条件下元件的电阻率与预期环境影响的关系。典型试验有:低温、干湿热、冲击、振动、温度波动等。

如果出于质量改进、精制或生产优化而要改变设计，则须另行通知。目录中所列出的都是与连接器（即必须在带电情况下插入或拔出的元件）相关的技术数据。为了保证正确使用该产品，列出了这些技术数据。可以采用这些数据来选择恰当的产品。以及描述该产品，但不能保证其性能。所有ESCHA连接器都是针对在工厂中的应用-电气设备控制所开发和设计的。由用户来验证在其它应用领域使用这些连接器的可能性。在性能及密封数据中，M12圆形连接器和M8圆形连接器的扭矩分别为1.0Nm和0.6Nm。所有国际防护等级代码相关数据都只能保证ESCHA元件的连接。

特性	标准 1)	注：
防护等级外壳	IEC60529	插入状态下的数据如需了解更多信息。
机械动作时间	IEC60512-5/9a	测试时不上电。
额定电压	IEC60664-1	通过污染程度及过电压类型来定义额定值
污染程度	IEC60664-1	
电流负荷	IEC60512-3/5b	
接触电阻	IEC60512-2/2a	整个定义范围内，插入状态下接触针/接触刷之间的接触电阻
绝缘电阻	IEC60512-2/3a	两个导电部位间的绝缘（取决于材料）

补充技术数据

1) 技术数据代表初始值，会按负载变化。安装导电法兰护套时，设备防护措施中要包括护套的相关内容。对所需连接的电缆进行绝缘时要保证其到导电部位的距离不会减少。焊接电缆时必须注意不让任何一根电线凸出，否则会造成短路。

	数字 1	数字 2
0	未经保护的	未经保护的
1	防止手压到危险部位。保护不受直径50mm固体异物的侵害。	防滴水
2	防止手指碰到危险部位。保护不受直径12.5mm固体异物的侵害。	电缆胶壳倾斜度达到15°时，防滴水。
3	防止工具碰到危险部位。保护不受直径2.5mm固体异物的侵害。	防喷雾
4	防止电线碰到危险部位。保护不受直径1毫米固体异物的侵害。	防洒水
5	防止电线碰到危险部位。防尘	防喷水
6	防止电线碰到危险部位。防尘	防止剧烈喷水
7		避免因暂时浸泡在水中所引起的不良后果。
8		避免因永久浸泡在水中所引起的不良后果。 (由制造商和用户来确定条件。但是，条件必须比IP_7更困难。)
9		防护高压蒸汽喷射清洗所产生的水

防护等级 | IP: 国际防护

为了安全起见，必须保护连接器不受环境因素的影响（例如灰尘、异物、触摸、湿气和水）。对于工业连接器，必须用护套及其堵头以及电缆出口上的绝缘来提供这样的防护。

防护等级用由两个特征字母IP（国际防护）以及两位数字所组成的缩写来表示。第一位数字表示表示该防护等级防触摸及防异物。第二位数字表示防止水侵入造成损坏。所有数据只有在锁定状态下才有效。

根据标准化测试过程来得出防护等级。

## 技术数据

### 额定电压

确定标准操作过程中的最大电压。圆形连接器的操作性能与额定电压相关。

### 绝缘电阻

根据IEC 60512-2, 3a和DIN EN 60512-2, 某一材料的绝缘能力被定义为在相邻触点或触点和地面之间形成尽可能高阻抗的能力。

### 电流负荷

根据DIN ISO 60512-33, 圆形连接器的电流负载定义了环境温度- 40°C. 下永久和同时流过所有触点的最大允许电流。电流相关自发总热量和环境温度不能超过圆形连接器所用材料热性能所确定的温度上限。所谓的降额曲线描绘出圆形连接器电流负载与环境温度之间的关系。实际情况中, 允许某个触点上出现电流过高, 因为并不是所有触点都在永久以最大速率通电。通过测试来确定每次精确值。

### 绝缘兼容性 ( 空气间隙和爬电距离 )

对于低压设备 (<1kV) 中的电气装置, DIN EN 60664 (DIN VDE 0110) 描述了测量绝缘空气间隙和爬电距离的过程。它定义了最小空气间隙 ( 空气中带电部位之间的最小距离 ) 和最小爬电距离 ( 绝缘面上带电部位之间的最小距离 ) 来避免电气闪络。最小爬电距离值取决于绝缘材料以及污染程度。

### 污染程度

污染程度 (1-4) 定义了介电强度和/或表面电阻减小时污染物 ( 固态、液态或气态杂质 ) 的量。对于工业应用, 污染程度通常为3: 发生导电性, 或干燥的非导电性污染。后者会通过预期的熔化而变得导电。

### 机械生命周期

定义插拔次数 ( 机械连接及断开圆形连接器的过程 ), 在此期间接触面上不会发生磨损, 避免接触电阻增大。



图 1 降额曲线



图 2 绝缘兼容性

## 技术数据

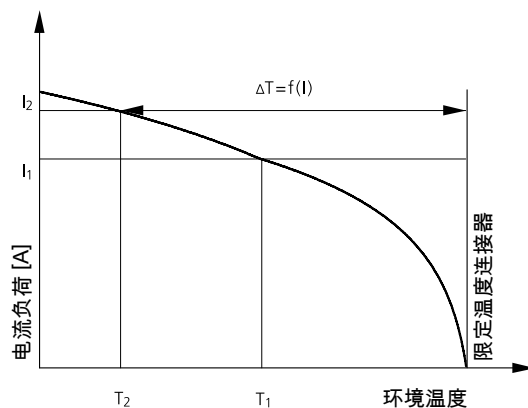
AWG	线结构 [毫米]	线直径[毫米]	线横截面积[平方毫米]
30	1 x 0.25   7 x 0.10	0.25   0.36	0.05   0.06
28	1 x 0.32   7 x 0.13	0.32   0.38	0.08   0.09
26	1 x 0.4   7 x 0.16   19 x 0.10	0.40   0.48   0.51	0.13   0.14   0.15
24	1 x 0.51   17 x 0.20   19 x 0.13	0.51   0.61   0.64	0.21   0.22   0.25
22	1 x 0.64   7 x 0.25   19 x 0.16	0.64   0.76   0.81	0.33   0.34   0.38
20	1 x 0.81   7 x 0.32   19 x 0.20	0.81   0.97   1.02	0.52   0.56   0.60
18	1 x 1.02   19 x 0.25	1.02   1.27	0.82   0.93
16	19 x 0.29	1.44	1.25
14	19 x 0.36	1.80	1.93
12	19 x 0.46	2.29	3.16
10	37 x 0.40	3.10	4.65

Pg	公制螺纹	最大扳手宽度[毫米]	最大角长度[毫米]
Pg7	M10x1.5   M12x1.5	16	18
Pg9   Pg11	M16x1.5	21	23
Pg13.5	M20x1.5	25	28

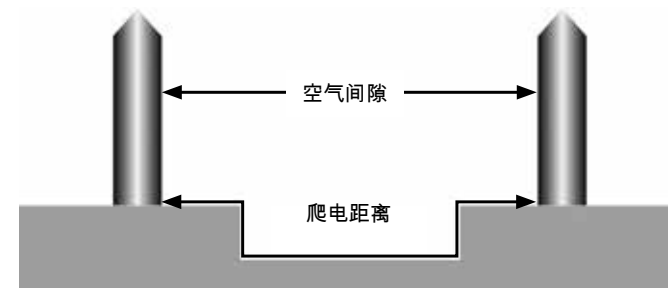
将美国线规AWG转换成平方毫米。

在某些工业领域，美国线规也用于电缆上。下表中就将AWG转换成平方毫米。应考虑到AWG号相同，但结构不同的电线，其横截面积也会略有差异。

德国Pg螺纹与公制螺纹概览

(在电缆螺纹连接上的扳手宽度根据 EN50262)

DIN 46320 “用德国Pg螺纹连接电缆和导线”的过渡期已于1999年12月31日过期。从那时开始，螺纹连接电缆和导线必须符合国家标准46319，直到2011年3月1日被EN 50262 替代。

## 认证

### UL (美国保险商实验室)

美国保险商实验室对产品、元件及材料的认证能证明其符合具体的安全要求。UL认证是进入美国及加拿大市场所必须的。

对于相关ESCHA产品，元件认证 (UL认证元件) 申请能确保其在安装进UL认证系统后成为UL认证元件。该元件认证也适用于相关使用过的电缆。单根电缆品质 (请见标准电缆品质表) 如具有UL上市认证标志 (设备认证) 能保证其符合有效的UL安全标准。



**ECOLAB**

#### ECOLAB

ECOLAB提供用于食品过程工业的专用洗涤剂和消毒剂。过去，公司对零件制造商进行抗ECOLAB测试。同时，零件供应商都配备了洗涤剂用于现场检测。ESCHA正在我们自己的测试实验室内开展类似的根据测试ECOLAB规格。



#### FDA

食品和药物管理局是国有控股的美国机构，主要负责食品和药品的控制批准。它定义了用于食物生产上的材料在生产过程中不会产生相互作用。在我们的卫生设计行产品系列中ESCHA只使用FDA-认证的材料。



#### 指令 2011/65/EG (RoHS-限制使用某些有害物质)

该限制在电气和电子设备中使用某些有害物质的欧盟指令，不允许这些有害物质在设备和元件中超过所确定的极限值。有害物质包括铅、镉、汞、六价铬、多溴联苯 (PBB) 和多溴联苯醚 (PBDE)。对于ESCHA产品，这意味着无铅焊接以及在塑料和电缆中不适用阻燃剂。



#### 指令 SJ/T 11364-2014 (中国RoHS标准)

对于ESCHA产品，所遵守的准则是包含EUP-标签 (环保使用期)。产品中的有害物质的允许残留量根据RoHS准则进行化学冲洗，处于正常的环境条件下，在50年的时间内不会泄漏 (EUP-标签码)



#### CE

CE认证表明产品的一致性通过欧盟协调标准中定义要求。



#### EAC-标志

制造商、经销商或授权代表在EAC标志上声明产品符合欧亚经济联盟现行技术法规的安全要求。EAC是欧亚整合的缩写。EAC标志于2013年8月推出。EAC标志的内容与欧洲CE标志相似。



#### 欧盟废旧电气及电子设备法令 (2012/19)

欧盟WEEE法令 (2012/19) (废旧电气及电子设备) 目的是避免电气及电子设备垃圾并且通过循环利用及其它处理方式减少垃圾。此法令规定了欧盟废旧电气及电子设备处理的最低标准。ESCHA是一家注册制造商(EAR-Registration No.DE58790594)。

由于电磁兼容性相关法律的颁布，设备电磁兼容性获得更多关注。  
必须用这样一种方式来制造该设备：

- 电磁干扰的产生必须限制在这些设备合适的运行范围内。
- 设备具有足够的抗电磁干扰的稳定性，以确保正确运行。

ESCHA双壳屏蔽的概念包括等电位表面通过两个互联金属壳来360°封装圆形连接器。模制电缆的屏蔽编织层在屏蔽套周围压接。根据IP67和IP69,即使在高机械应力、高压蒸汽喷射清洗时的防尘防水条件下，该双组分包胶模也能提供360°屏蔽。

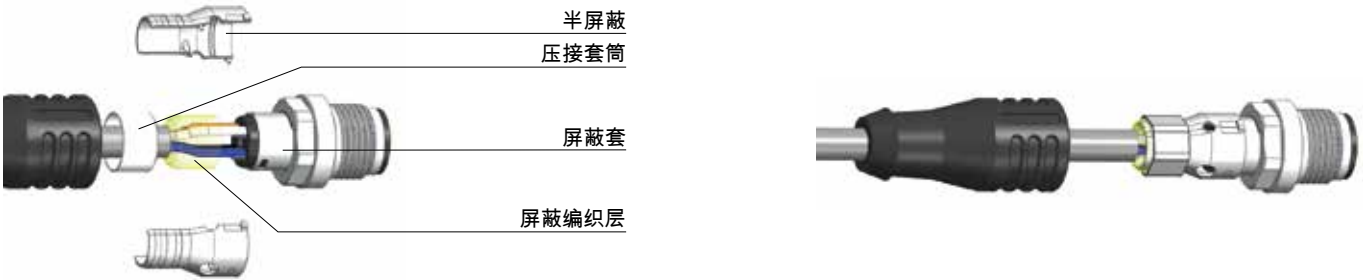

接线说明

正确安装圆形连接器以及专业布线是制造商确保紧密且可靠的电气连接的先决条件。为了避免损坏圆形连接器和电缆，在布线过程中注意观察电缆的最小弯曲半径 ( $r_{min}$ )。

数据总线是高性能的产品。避免了在安装和使用中的任何机械影响，例如挤压、锐利的捕捉和牵引力，并确保永久和安全的数据传输。在零下温度时安装需要小心，因为塑料在低温时拥有不同的特性，产品末端可能会损坏。使用电缆扎带来捆绑电缆或永久布线时，扎带不能切入电缆或使其变形，从而避免短路、电缆中断或介电强度降低。

对于中继电缆，连接器间的电缆长度要足够长，来吸收运动时所产生的能量。使用电缆线路、螺旋线或电缆链来使圆形连接器系统获得较长的使用寿命。

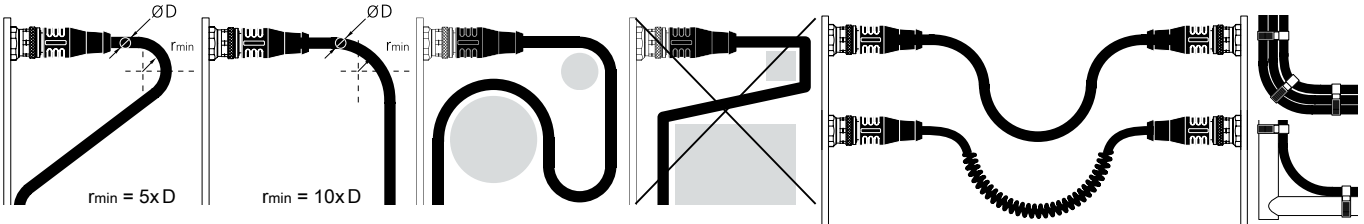

推荐的拧紧转矩

推荐使用扭矩应用工具来旋紧和松开圆形连接器。建议参数的获得是建立在内部的一些测试和大量的产品组合和应用基础上。由于产品种类和组合繁多，具体的应用还需根据实际的使用环境来选择。

推荐带扭矩的螺帽拧紧式，符合IEC61076-2 标准

连接头	M12	1.0Nm
	M8	0.6Nm
法兰	M12	2.0Nm
	M8	1.5Nm
阀连接器	VA	1.0Nm
	VB   VBI	1.0Nm
	VC   VCI	0.6Nm

针脚分配 M12 | A

传感器/执行机构：AL | FB | HT

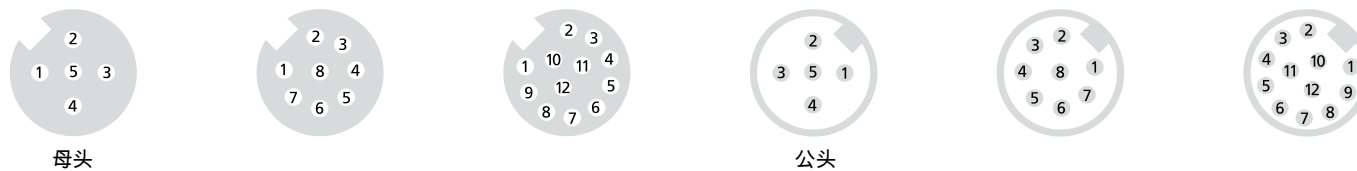

针脚数	编码	触点											
		1	2	3	4	5	6	7	8	9	10	11	12
3	A	BN		BU	BK								
4	A	BN	WH	BU	BK								
4+PE	A	BN	WH	BU	BK	GNYE							
5	A	BN	WH	BU	BK	GY							
8	A	WH	BN	GN	YE	GY	PK	BU	RD				
12	A	BN	BU	WH	GN	PK	YE	BK	GY	RD	VT	GY/PK	RDBU

M8/Ø8mm快插针脚分配

传感器/执行机构：AL | FB | HT



针脚数	针脚分配代码	触点									
		1	2	3	4	5					
3		BN		BU	BK						
4		BN	WH	BU	BK						
4	4.028	BN		BU	BK						
5		BN	WH	BU	BK	GY					



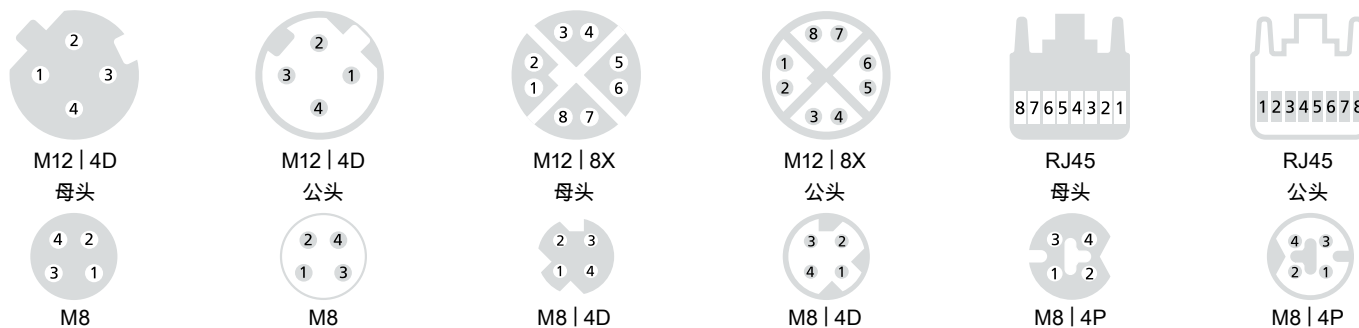

类型	引脚数	编码	引脚分配代码	引脚数								
				1	2	3	4	5	6	7	8	
M12	4	D	4.029	YE	WH	OG	BU					
M12	4	D	4.082	WHOG	WHBU	OG	BU					
M12	8	X	8.066	WH	OG	WH	GN	WH	BN	WH	BU	
RJ45	4		4.003	YE	OG	WH			BU			
RJ45	4		8.005	WHOG	OG	WHBU			BU			
RJ45	8		8.002	WHOG	OG	WHGN	BU	WHBU	GN	WHBN	BN	
M8	4		4.027	WHOG	WHBU	BU	OG					
M8	4	P	4.054	YE	WH	BU	OG					
M8	4	D	4.071	WHOG	OG	WHBU	BU					
M8	4	D	4.073	YE	WH	OG	BU					



类型	引脚数	编码	引脚分配代码	引脚数					
				1	2	3	4	5	
M12	5	B	2.012		GN		RD		



类型	引脚数	编码	引脚分配代码	引脚数				
				1	2	3	4	5
M12	4+GND	A	5.022	GND	RD	BK	WH	BU
					+	-	CAN_H	CAN_L

针脚分配 M12 POWER 电源  
PS | PT | PK | PL

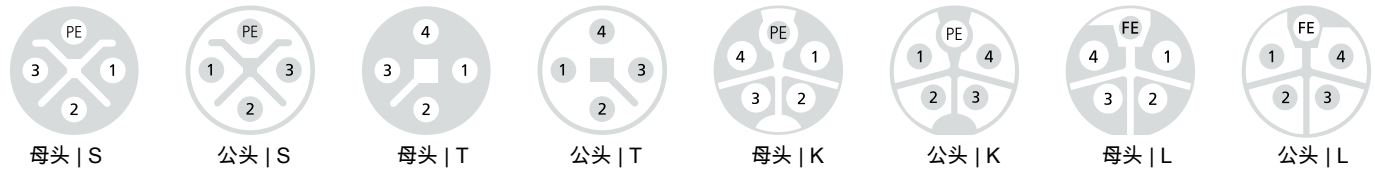

针脚数	编码	针脚分配代码	1	2	3	4	5						
2+PE	S	3.002	BN		BU	GNYE							
3+PE	S	4.155	BN	BK	GY	GNYE							
4	T	4	BN	WH	BU	BK							
4+PE	K	5.244	BK	BN	GY	BU	GNYE						
4	L	4	BN	WH	BU	BK							
4+FE	L	5.269	BN	WH	BU	BK	GY						

M12 I/O 分配器



M12x1																			
I/O	1		2		3		4		5		6		7		8		alle	alle	alle
I/O_针	2	4	2	4	2	4	2	4	2	4	2	4	2	4	2	4	1	3	5
M23_12 针	-	1	-	2	-	3	-	4	-	5	-	6	-	7	-	8	11	9+10	12
M23_19 针	7	15	4	5	8	16	14	3	9	17	13	2	10	11	18	1	19	6	12
电缆	GYPK	WH	RDBU	GN	WHGN	YE	BNGN	GY	WHYE	PK	YEBN	RD	WHGY	BK	GYBN	VT	BN(+)	BU(-)	GNYE

M8/Ø8mm 快插 I/O 分配器



M8/Ø8mm 快插																				
I/O	1		2		3		4		5		6		7		8		9	10	alle	
I/O_触点	4	2	4	2	4	2	4	2	4	2	4	2	4	2	4	2	4	4	1 3	
M12_12 pins (I/O 3 针)	3	-	4	-	6	-	8	-	5	-	9	-	7	-	10	-	11	12	1 2	
M12_12 pins (I/O 4 针)	3	5	4	9	6	7	8	10	-	-	-	-	-	-	-	-	11	12	1 2	
M12_8 针	1	-	2	-	3	-	4	-	-	-	-	-	-	-	-	-	-	-	5 7	
电缆	WH	GYPK	GN	RDBU	YE	WHGN	GY	BNGN	PK	WHYE	RD	YEBN	BK	WHGY	VT	GYBN	WHPK	BNPK	BN(+)	BU(-)

针脚分配 M23 连接器

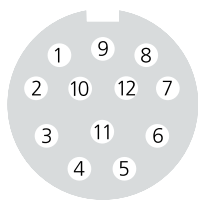

母头

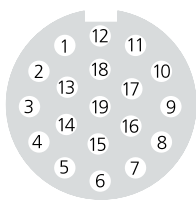

公头

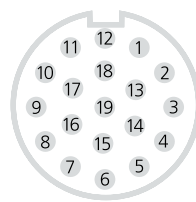
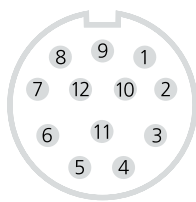

	针脚数																		
	1	2	3	4	5	6	7	8	9	10	11	12	13	14	15	16	17	18	19
12.001	WH	GN	YE	GY						BU	BN	GNYE							
12.003	WH	GN	YE	GY	PK	RD	BK	VT		BU	BN	GNYE							
19.001			GY	RDBU	GN	BU	GYPK	WHGN				GNYE		BNGN	WH	YE			BN
19.003	VT	RD	GY	RDBU	GN	BU	GYPK	WHGN	WHYE	WHGY	BK	GNYE	YE BN	BNGN	WH	YE	PK	GYBN	BN

阀连接器针脚分配

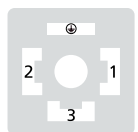

VA21

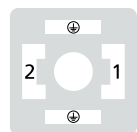

VA22

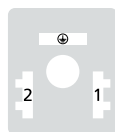

VB21

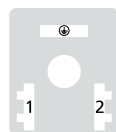

VBI22

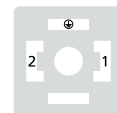

VC21

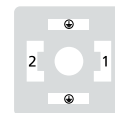

VC22

类型	针脚数		Pin							
			1	2	3   PE	PE				
A	21	2 触点 + PE	BN	BU		GNYE				
A	22	2 触点 + PE 跳线	BN	BU		GNYE				
A	41	3 触点 + PE + 电线连接	BN	WH	BK	GNYE				
B   BI	21	2 触点 + PE	BN	BU		GNYE				
C   CI	21	2 触点 + PE	BN	BU		GNYE				
C   CI	22	2 触点 + PE 跳线	BN	BU		GNYE				



让我们转到escha.net

在网络上，您可以找到有关ESCHA在德国以外的销售办事处、合作伙伴以及我们产品的详细信息。访问escha.net可轻松地使用的产品搜索或下载电子目录。单击项目编号，将会直接重定向到所需项目的详细信息。之后，可以免费下载我们的数据表和步骤文件。